

# CM1436

## 4-, 6- and 8-Channel EMI Filter Arrays with ESD Protection

### Product Description

The CM1436 is an EMI filter array with ESD protection, which integrates either four, six or eight pi filters (C-R-C). Each CM1436 filter has component values of 15 pF – 200 Ω – 15 pF. These parts include ESD protection diodes on every pin, providing a very high level of protection for sensitive electronic components that may be subjected to electrostatic discharge (ESD). The ESD diodes connected to the filter ports safely dissipate ESD strikes of ±15 kV contact discharge, twice the specification requirement of the IEC 61000-4-2, Level 4 international standard. Using the MIL-STD-883 (Method 3015) specification for Human Body Model (HBM) ESD, the pins are protected for contact discharges at greater than ±30 kV.

This device is particularly well-suited for portable electronics (e.g. mobile handsets, PDAs, notebook computers) because of its small package and easy-to-use pin assignments. In particular, the CM1436 is ideal for EMI filtering and protecting data lines from ESD in wireless handsets.

The CM1436 is available in space-saving, low-profile, 8-lead, 12-lead and 16-lead 0.4 mm pitch WDFN packages. It is fabricated with *Centurion*™ process and available with lead-free finishing.

### Features

- Four, Six and Eight Channels of EMI Filtering with ESD Protection
- Greater than 30 dB of Attenuation from 800 MHz to 3 GHz
- ±15 kV ESD Protection (IEC 61000-4-2, Contact Discharge)
- ±30 kV ESD Protection (HBM)
- Fabricated with *Centurion*™ Advanced Low Capacitance Zener Process Technology
- Space Saving, Low-Profile 8-, 12- and 16-lead 0.4 mm Pitch WDFN Packages
- These Devices are Pb-Free and are RoHS Compliant

### Applications

- I/O Port Protection for Mobile Handsets, Notebook Computers, PDAs, etc.
- EMI Filtering for Data Ports in Cell Phones, PDAs or Notebook Computers
- EMI Filtering for LCD, Camera and Chip-to-Chip Data Lines



ON Semiconductor®

<http://onsemi.com>



WDFN8  
DF/DE SUFFIX  
CASE 511BF



WDFN12  
DF/DE SUFFIX  
CASE 511BC

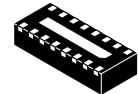

WDFN16  
DF/DE SUFFIX  
CASE 511AW

### BLOCK DIAGRAM

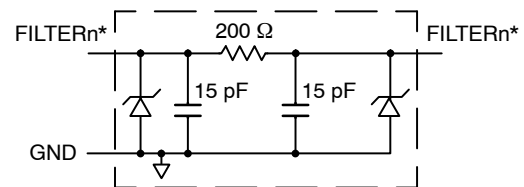

1 of 4/6/8 EMI Filtering + ESD Channels

\* See Package/Pinout Diagrams for expanded pin information.

### MARKING DIAGRAM



6F/6E = CM1436-04DF/CM1436-04DE

N36F/N36E = CM1436-06DF/CM1436-06DE

N368F/N368E = CM1436-08DF/CM1436-08DE

### ORDERING INFORMATION

Device	Package	Shipping†
CM1436-04DF	WDFN-8 (Pb-Free)	3000/Tape & Reel
CM1436-04DE	WDFN-8 (Pb-Free)	3000/Tape & Reel
CM1436-06DF	WDFN-12 (Pb-Free)	3000/Tape & Reel
CM1436-06DE	WDFN-12 (Pb-Free)	3000/Tape & Reel
CM1436-08DF	WDFN-16 (Pb-Free)	3000/Tape & Reel
CM1436-08DE	WDFN-16 (Pb-Free)	3000/Tape & Reel

†For information on tape and reel specifications, including part orientation and tape sizes, please refer to our Tape and Reel Packaging Specification Brochure, BRD8011/D.

# CM1436

## PACKAGE / PINOUT DIAGRAMS

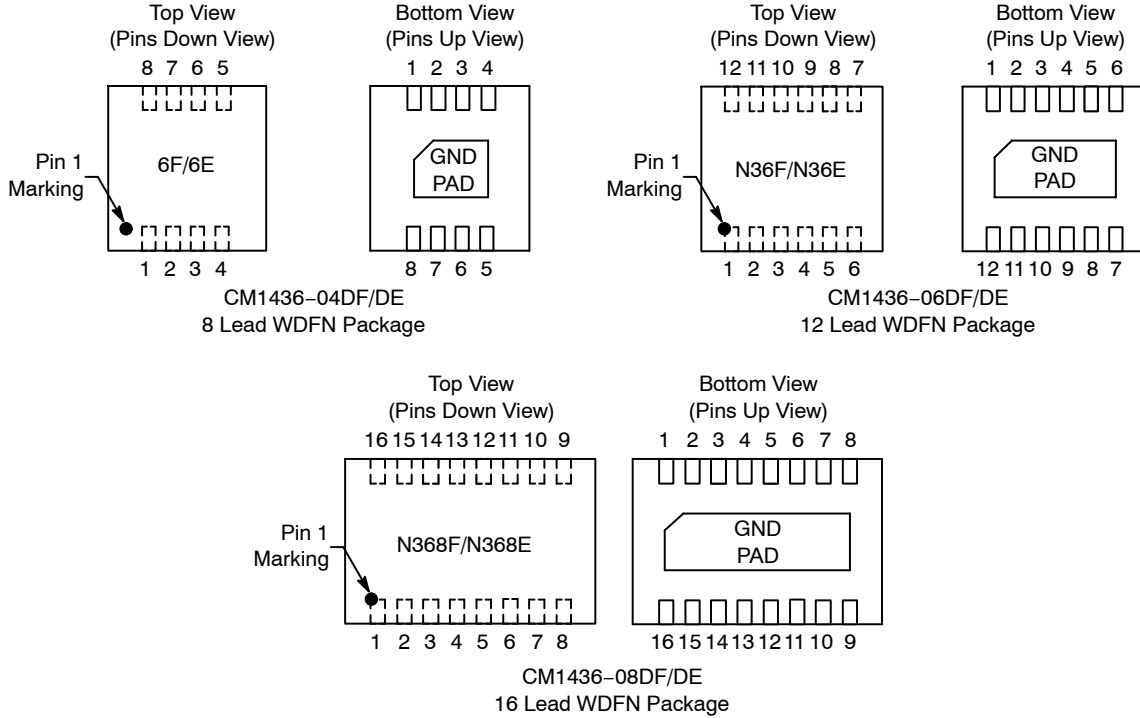

**Table 1. PIN DESCRIPTIONS**

Pins			Name	Description	Pins			Name	Description
1436-04Dx	1436-06Dx	1436-08Dx			1436-04Dx	1436-06Dx	1436-08Dx		
1	1	1	FILTER1	Filter Channel 1	8	12	16	FILTER1	Filter Channel 1
2	2	2	FILTER2	Filter Channel 2	7	11	15	FILTER2	Filter Channel 2
3	3	3	FILTER3	Filter Channel 3	6	10	14	FILTER3	Filter Channel 3
4	4	4	FILTER4	Filter Channel 4	5	9	13	FILTER4	Filter Channel 4
-	5	5	FILTER5	Filter Channel 5	-	8	12	FILTER5	Filter Channel 5
-	6	6	FILTER6	Filter Channel 6	-	7	11	FILTER6	Filter Channel 6
-	-	7	FILTER7	Filter Channel 7	-	-	10	FILTER7	Filter Channel 7
-	-	8	FILTER8	Filter Channel 8	-	-	9	FILTER8	Filter Channel 8
GND PAD			GND	Device Ground	-	-	-	-	

## SPECIFICATIONS

**Table 2. ABSOLUTE MAXIMUM RATINGS**

Parameter	Rating	Units
Storage Temperature Range	-65 to +150	°C
DC Power per Resistor	100	mW
DC Package Power Rating	300	mW

Stresses exceeding Maximum Ratings may damage the device. Maximum Ratings are stress ratings only. Functional operation above the Recommended Operating Conditions is not implied. Extended exposure to stresses above the Recommended Operating Conditions may affect device reliability.

# CM1436

## SPECIFICATIONS (Cont'd)

**Table 3. STANDARD OPERATING CONDITIONS**

Parameter	Rating	Units
Operating Temperature Range	-40 to +85	°C

**Table 4. ELECTRICAL OPERATING CHARACTERISTICS** (Note 1)

Symbol	Parameter	Conditions	Min	Typ	Max	Units
R	Resistance		160	200	240	Ω
C	Capacitance C	At 2.5 V DC, 1 MHz, 30 mV AC	12	15	18	pF
V <sub>DIODE</sub>	Diode Stand-off Voltage	I <sub>DIODE</sub> = 10 μA		6.0		V
I <sub>LEAK</sub>	Diode Leakage Current (Reverse Bias)	V <sub>DIODE</sub> = 3.3 V		0.1	1.0	μA
V <sub>SIG</sub>	Signal Voltage Positive Clamp Negative Clamp	I <sub>LOAD</sub> = 10 mA I <sub>LOAD</sub> = -10 mA	5.6 -0.4	6.8 -0.8	9.0 -1.5	V
V <sub>ESD</sub>	In-system ESD Withstand Voltage a) Human Body Model, MIL-STD-883, Method 3015 b) Contact Discharge per IEC 61000-4-2 Level 4	(Note 2)	±30 ±15			kV
f <sub>C</sub>	Cut-off Frequency Z <sub>SOURCE</sub> = 50 Ω, Z <sub>LOAD</sub> = 50 Ω	R = 200 Ω, C = 15 pF		100		MHz
A <sub>1GHz</sub>	Absolute Attenuation @ 1 GHz from 0 dB Level	Z <sub>SOURCE</sub> = 50 Ω, Z <sub>LOAD</sub> = 50 Ω, DC Bias = 0 V (Note 1)		35		dB
A <sub>800Mhz - 6GHz</sub>	Absolute Attenuation @ 800 MHz to 6 GHz from 0 dB Level	Z <sub>SOURCE</sub> = 50 Ω, Z <sub>LOAD</sub> = 50 Ω, DC Bias = 0 V (Notes 1 and 3)		30		dB

1. T<sub>A</sub> = 25°C unless otherwise specified.
2. ESD applied to input and output pins with respect to GND, one at a time.
3. Attenuation / RF curves characterized by a network analyzer using microprobes.

## PERFORMANCE INFORMATION

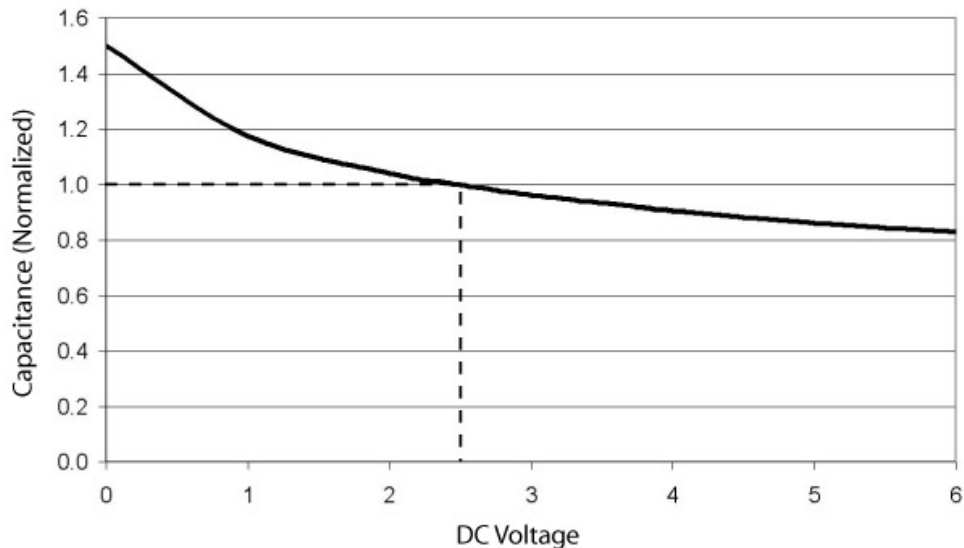

**Figure 1. Filter Capacitance vs. Input Voltage over Temperature  
(normalized to capacitance at 2.5 V DC and 25°C)**

# CM1436

## PERFORMANCE INFORMATION (Cont'd)

Typical Filter Performance (nominal conditions unless specified otherwise, 0 V DC Bias, 50 Ω Environment)

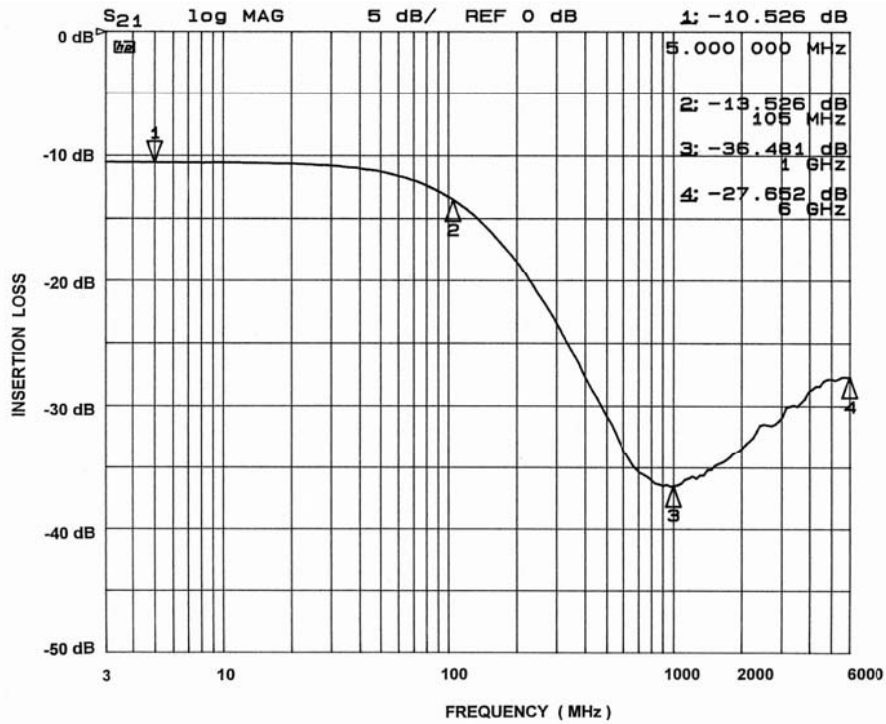

Figure 2. Channel 1 EMI Filter Performance (CM1436-04 Only)

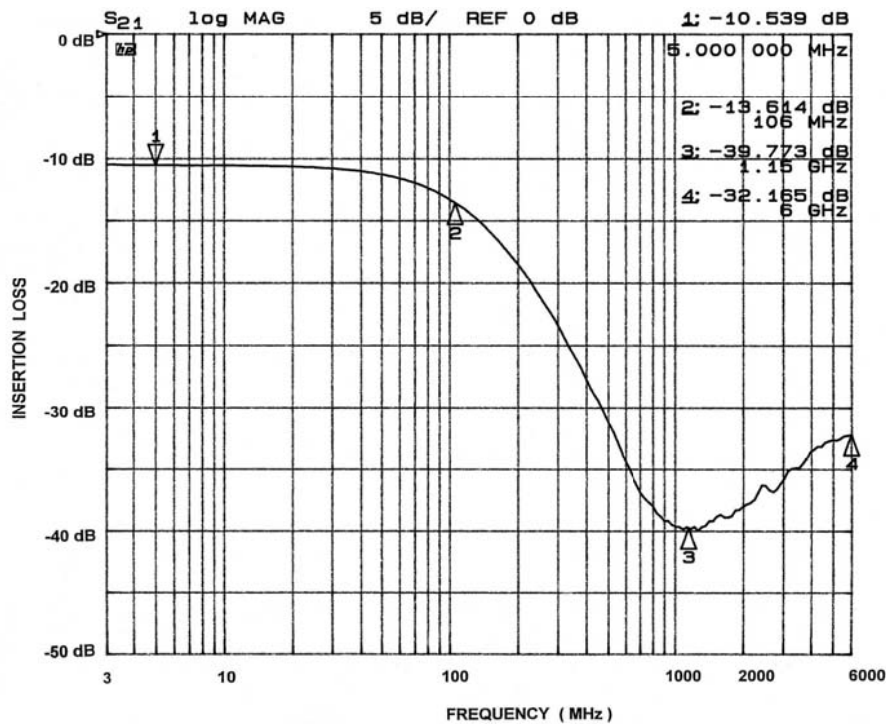

Figure 3. Channel 2 EMI Filter Performance (CM1436-04 Only)

# CM1436

## PERFORMANCE INFORMATION (Cont'd)

Typical Filter Performance (nominal conditions unless specified otherwise, 0 V DC Bias, 50 Ω Environment)

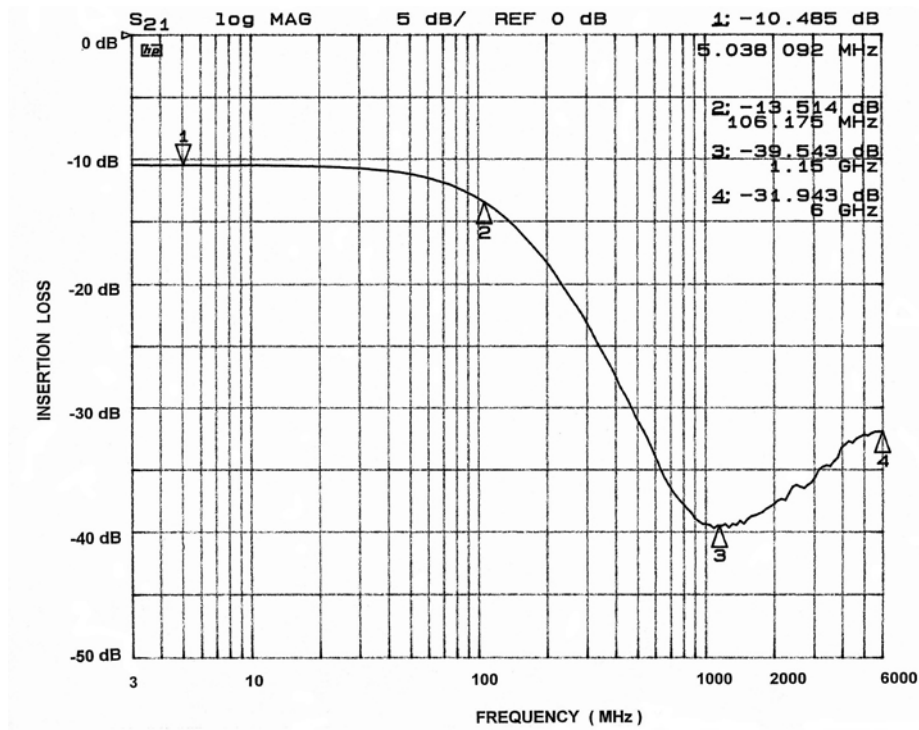

Figure 4. Channel 3 EMI Filter Performance (CM1436-04 Only)

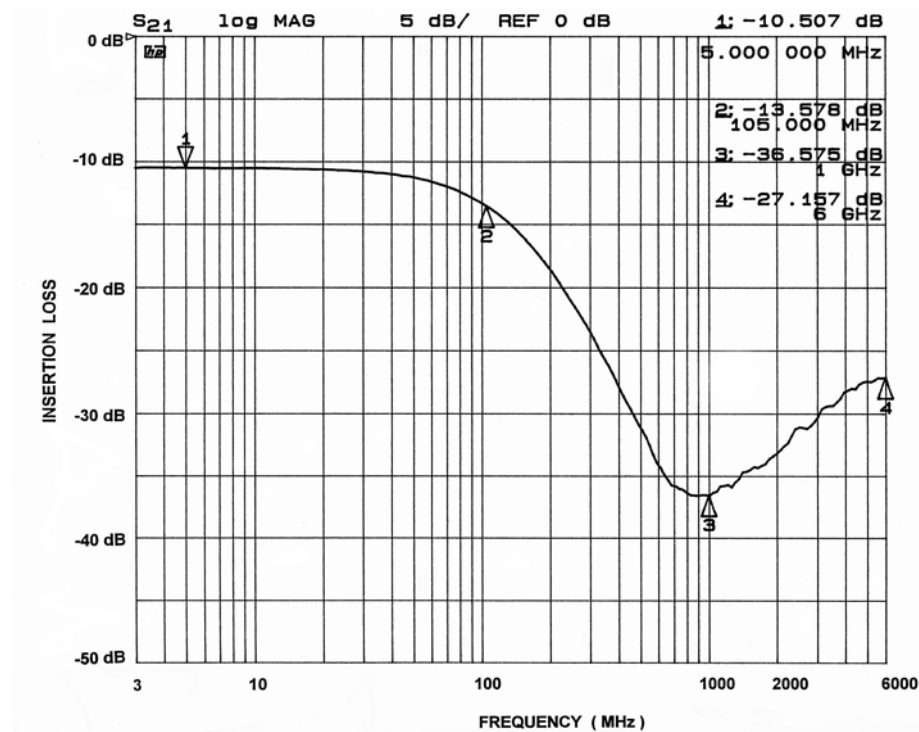

Figure 5. Channel 4 EMI Filter Performance (CM1436-04 Only)

# CM1436

## PERFORMANCE INFORMATION (Cont'd)

Typical Filter Performance (nominal conditions unless specified otherwise, 0 V DC Bias, 50  $\Omega$  Environment)

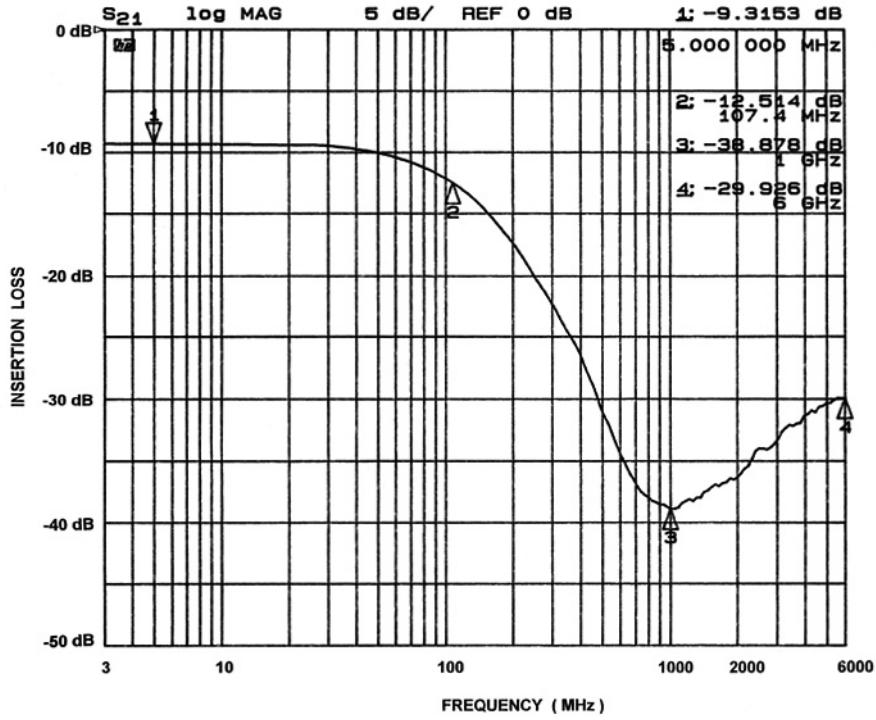

Figure 6. Channel 1 EMI Filter Performance (CM1436-06/08 Only)

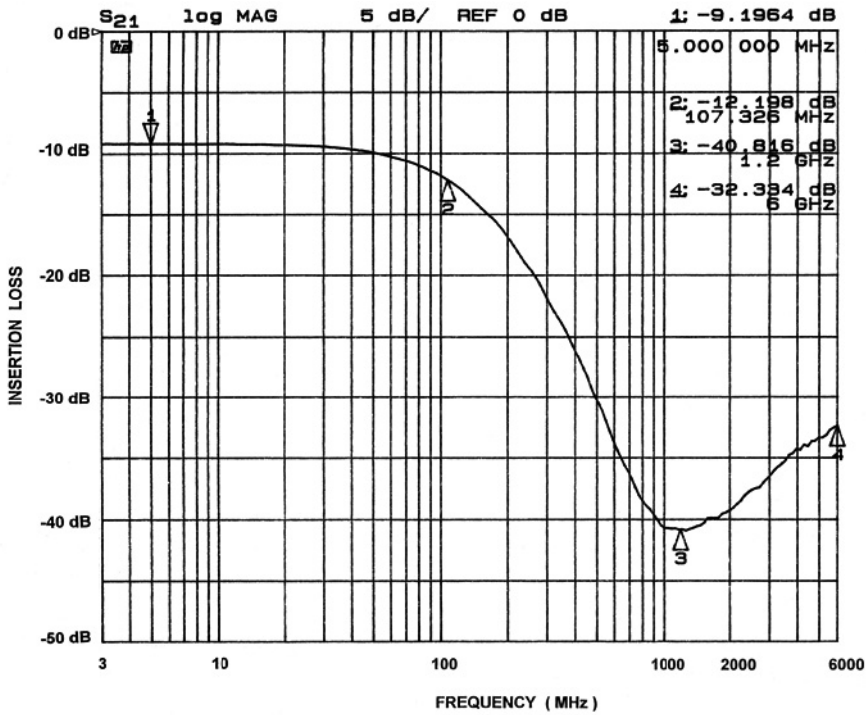

Figure 7. Channel 2 EMI Filter Performance (CM1436-06/08 Only)

# CM1436

## PERFORMANCE INFORMATION (Cont'd)

Typical Filter Performance (nominal conditions unless specified otherwise, 0 V DC Bias, 50 Ω Environment)

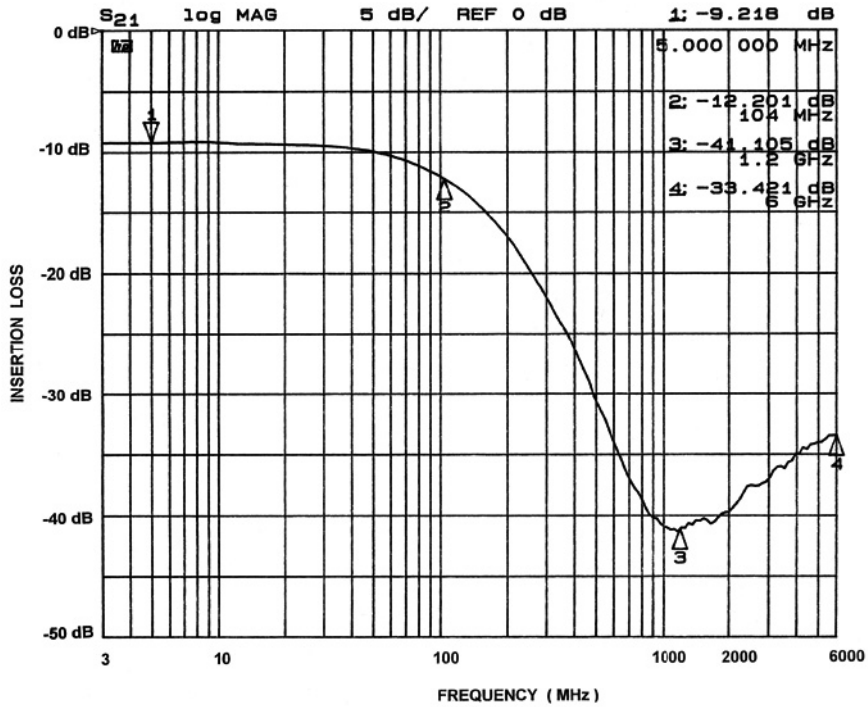

Figure 8. Channel 3 EMI Filter Performance (CM1436-06/08 Only)

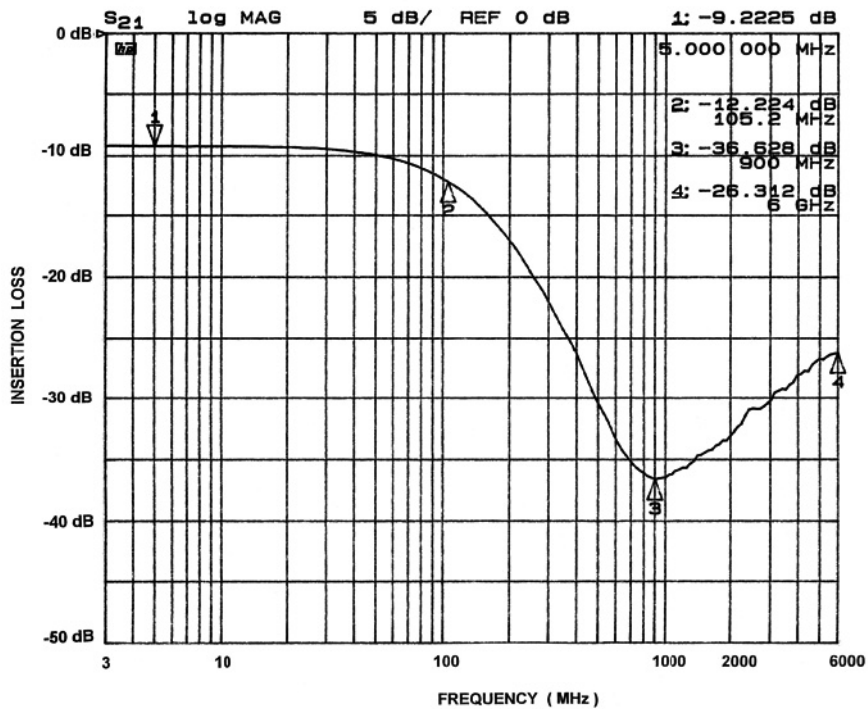

Figure 9. Channel 4 EMI Filter Performance (CM1436-06/08 Only)

# CM1436

## PERFORMANCE INFORMATION (Cont'd)

Typical Filter Performance (nominal conditions unless specified otherwise, 0 V DC Bias, 50 Ω Environment)

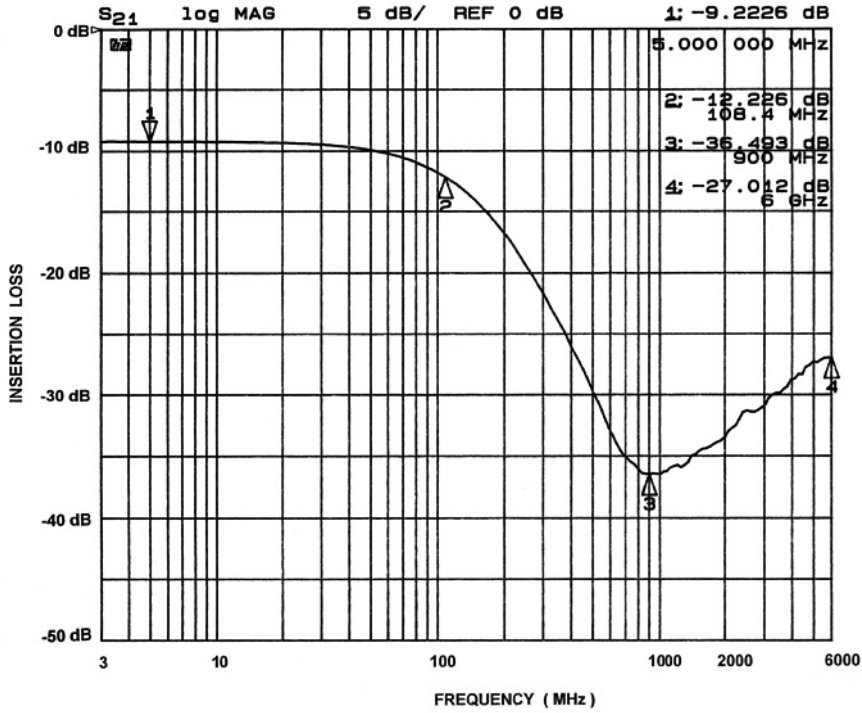

Figure 10. Channel 5 EMI Filter Performance (CM1436-06/08 Only)

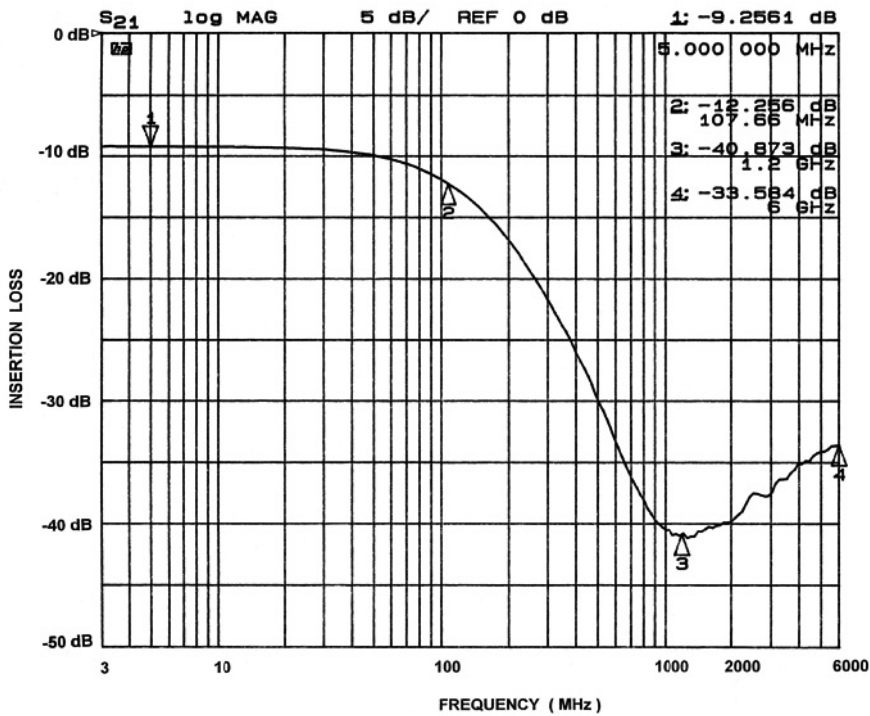

Figure 11. Channel 6 EMI Filter Performance (CM1436-06/08 Only)



# CM1436

## PERFORMANCE INFORMATION (Cont'd)

Typical Filter Performance (nominal conditions unless specified otherwise, 0 V DC Bias, 50 Ω Environment)

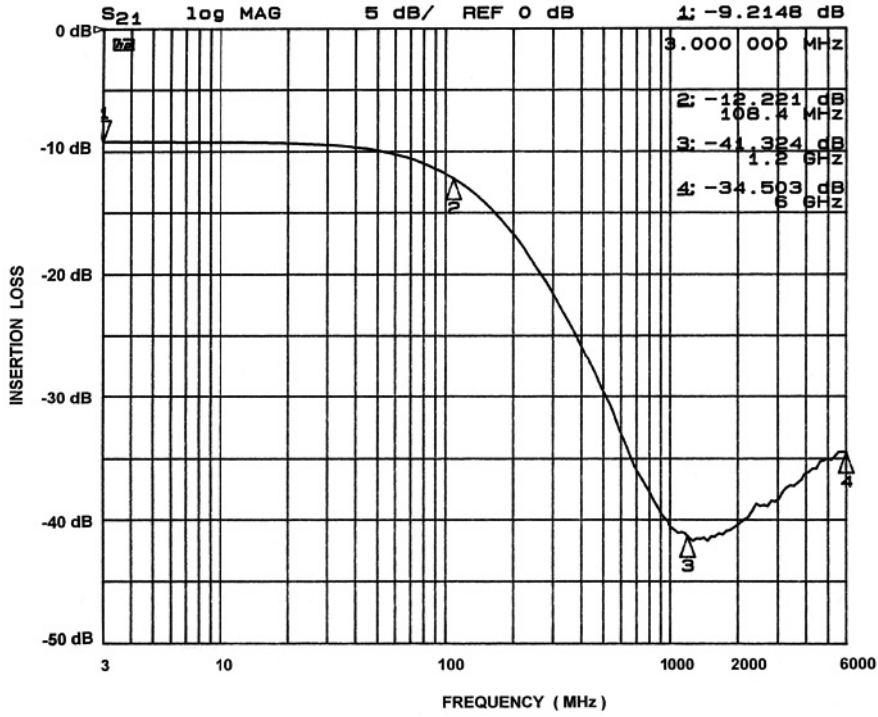

Figure 12. Channel 7 EMI Filter Performance (CM1436-08 Only)

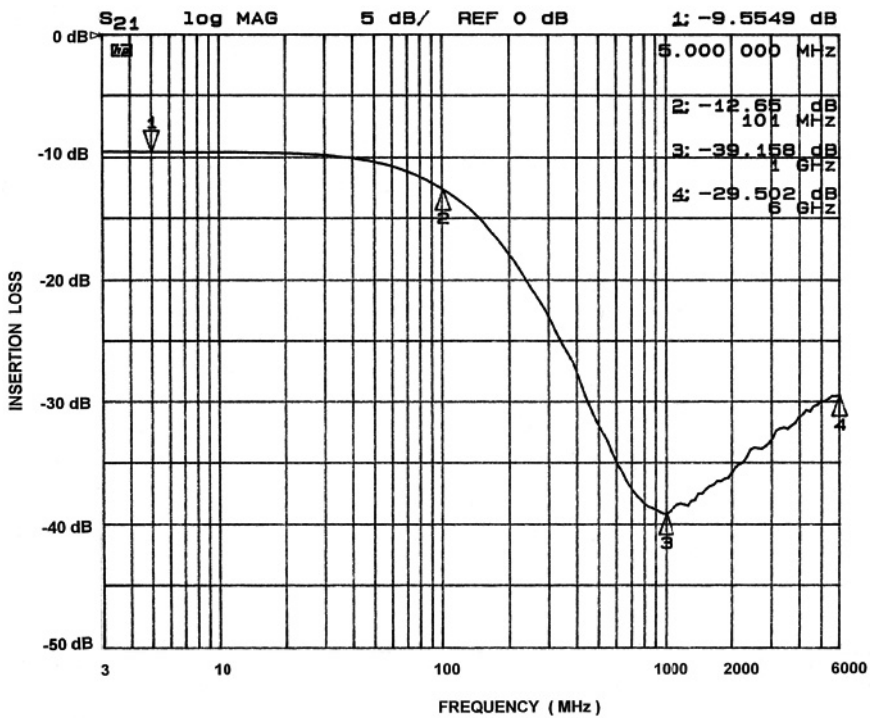
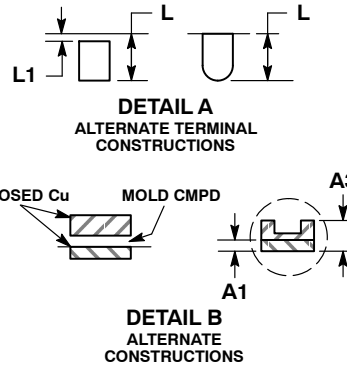
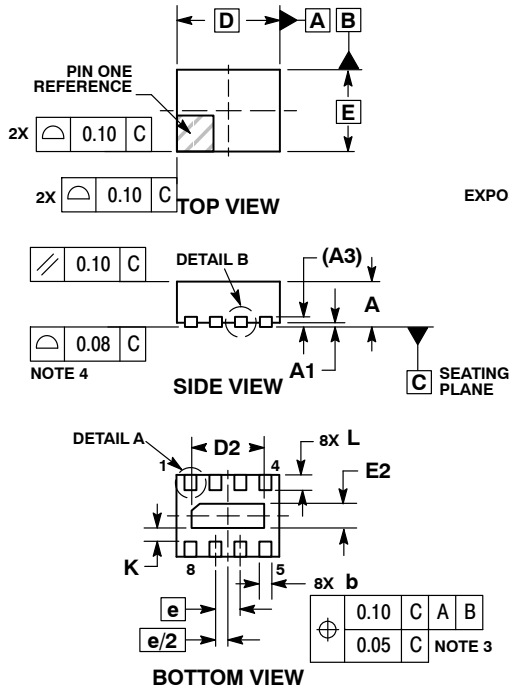

Figure 13. Channel 8 EMI Filter Performance (CM1436-08 Only)

# CM1436

## PACKAGE DIMENSIONS

WDFN8, 1.7x1.35, 0.4P  
CASE 511BF-01  
ISSUE O



**NOTES:**

1. DIMENSIONING AND TOLERANCING PER ASME Y14.5M, 1994.
2. CONTROLLING DIMENSION: MILLIMETERS.
3. DIMENSION b APPLIES TO PLATED TERMINAL AND IS MEASURED BETWEEN 0.15 AND 0.30 MM FROM TERMINAL TIP.
4. COPLANARITY APPLIES TO THE EXPOSED PAD AS WELL AS THE TERMINALS.

MILLIMETERS		
DIM	MIN	MAX
A	0.70	0.80
A1	0.00	0.05
A3	0.20	REF
b	0.15	0.25
D	1.7	BSC
D2	1.10	1.30
E	1.35	BSC
E2	0.30	0.50
e	0.40	BSC
K	0.22	REF
L	0.15	0.35
L1	---	0.15

**RECOMMENDED SOLDERING FOOTPRINT\***

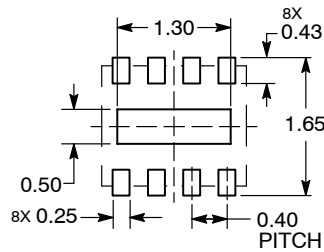

DIMENSION: MILLIMETERS

\*For additional information on our Pb-Free strategy and soldering details, please download the ON Semiconductor Soldering and Mounting Techniques Reference Manual, SOLDERRM/D.

# CM1436

## PACKAGE DIMENSIONS

WDFN12, 2.5x1.35, 0.4P  
CASE 511BC-01  
ISSUE O

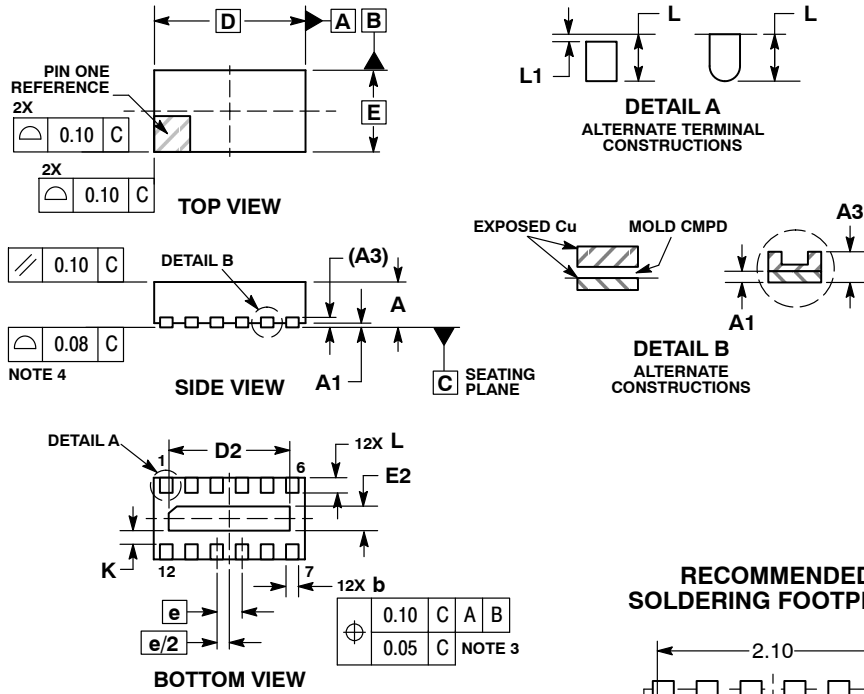

- NOTES:
1. DIMENSIONING AND TOLERANCING PER ASME Y14.5M, 1994.
  2. CONTROLLING DIMENSION: MILLIMETERS.
  3. DIMENSION b APPLIES TO PLATED TERMINAL AND IS MEASURED BETWEEN 0.15 AND 0.30 MM FROM TERMINAL TIP.
  4. COPLANARITY APPLIES TO THE EXPOSED PAD AS WELL AS THE TERMINALS.

MILLIMETERS		
DIM	MIN	MAX
A	0.70	0.80
A1	0.00	0.05
A3	0.20	REF
b	0.15	0.25
D	2.50	BSC
D2	1.90	2.10
E	1.35	BSC
E2	0.30	0.50
e	0.40	BSC
K	0.22	REF
L	0.15	0.35
L1	---	0.15

### RECOMMENDED SOLDERING FOOTPRINT\*

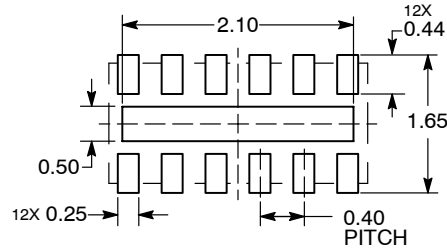

DIMENSION: MILLIMETERS

\*For additional information on our Pb-Free strategy and soldering details, please download the ON Semiconductor Soldering and Mounting Techniques Reference Manual, SOLDERRM/D.

# CM1436

## PACKAGE DIMENSIONS

**WDFN16, 3.3x1.35, 0.4P**  
**CASE 511AW-01**  
**ISSUE 0**

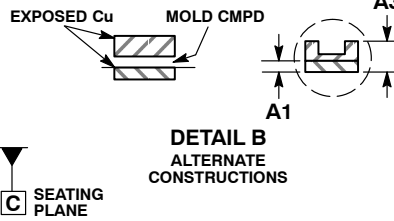
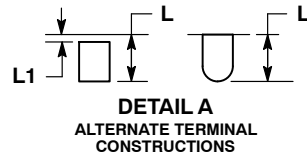
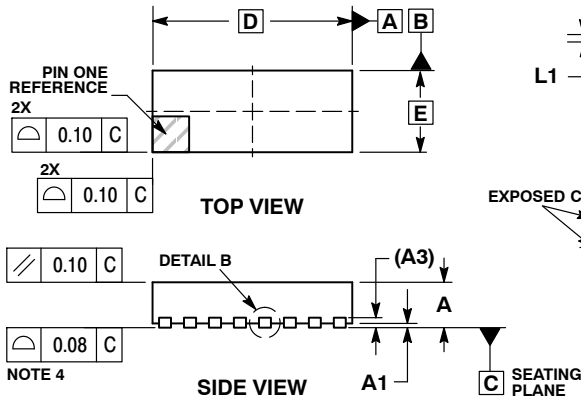

**NOTES:**

1. DIMENSIONING AND TOLERANCING PER ASME Y14.5M, 1994.
2. CONTROLLING DIMENSION: MILLIMETERS.
3. DIMENSION b APPLIES TO PLATED TERMINAL AND IS MEASURED BETWEEN 0.15 AND 0.30 MM FROM TERMINAL TIP.
4. COPLANARITY APPLIES TO THE EXPOSED PAD AS WELL AS THE TERMINALS.

MILLIMETERS		
DIM	MIN	MAX
A	0.70	0.80
A1	0.00	0.05
A3	0.20	REF
b	0.15	0.25
D	3.30	BSC
D2	2.70	2.90
E	1.35	BSC
E2	0.30	0.50
e	0.40	BSC
K	0.22	REF
L	0.15	0.35
L1	---	0.15

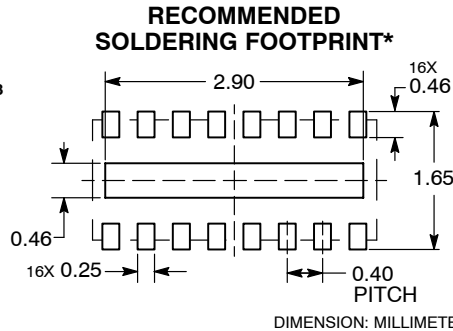
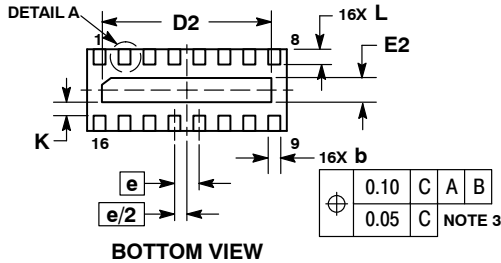

\*For additional information on our Pb-Free strategy and soldering details, please download the ON Semiconductor Soldering and Mounting Techniques Reference Manual, SOLDERRM/D.

Centurion is a trademark of Semiconductor Components Industries, LCC (SCILCC).

ON Semiconductor and are registered trademarks of Semiconductor Components Industries, LLC (SCILLC). SCILLC reserves the right to make changes without further notice to any products herein. SCILLC makes no warranty, representation or guarantee regarding the suitability of its products for any particular purpose, nor does SCILLC assume any liability arising out of the application or use of any product or circuit, and specifically disclaims any and all liability, including without limitation special, consequential or incidental damages. "Typical" parameters which may be provided in SCILLC data sheets and/or specifications can and do vary in different applications and actual performance may vary over time. All operating parameters, including "Typicals" must be validated for each customer application by customer's technical experts. SCILLC does not convey any license under its patent rights nor the rights of others. SCILLC products are not designed, intended, or authorized for use as components in systems intended for surgical implant into the body, or other applications intended to support or sustain life, or for any other application in which the failure of the SCILLC product could create a situation where personal injury or death may occur. Should Buyer purchase or use SCILLC products for any such unintended or unauthorized application, Buyer shall indemnify and hold SCILLC and its officers, employees, subsidiaries, affiliates, and distributors harmless against all claims, costs, damages, and expenses, and reasonable attorney fees arising out of, directly or indirectly, any claim of personal injury or death associated with such unintended or unauthorized use, even if such claim alleges that SCILLC was negligent regarding the design or manufacture of the part. SCILLC is an Equal Opportunity/Affirmative Action Employer. This literature is subject to all applicable copyright laws and is not for resale in any manner.

### PUBLICATION ORDERING INFORMATION

**LITERATURE FULFILLMENT:**  
 Literature Distribution Center for ON Semiconductor  
 P.O. Box 5163, Denver, Colorado 80217 USA  
**Phone:** 303-675-2175 or 800-344-3860 Toll Free USA/Canada  
**Fax:** 303-675-2176 or 800-344-3867 Toll Free USA/Canada  
**Email:** orderlit@onsemi.com

**N. American Technical Support:** 800-282-9855 Toll Free  
 USA/Canada  
**Europe, Middle East and Africa Technical Support:**  
 Phone: 421 33 790 2910  
**Japan Customer Focus Center**  
 Phone: 81-3-5773-3850

**ON Semiconductor Website:** [www.onsemi.com](http://www.onsemi.com)  
**Order Literature:** <http://www.onsemi.com/orderlit>  
 For additional information, please contact your local Sales Representative