

XPT IGBT Module

preliminary

$$V_{CES} = 1200 \text{ V}$$

$$I_{C25} = 220 \text{ A}$$

$$V_{CE(sat)} = 1,8 \text{ V}$$

Buck Chopper

Part number

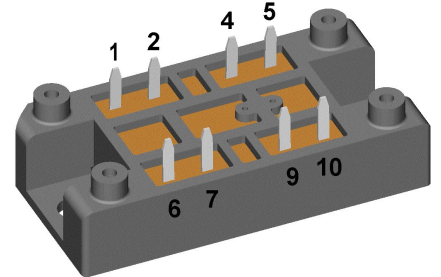
MIXA150Q1200VA

Backside: isolated

E72873

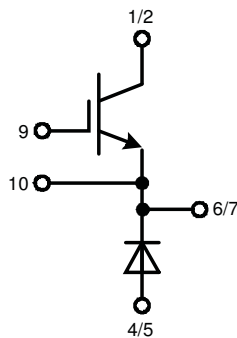

Features / Advantages:

- Easy paralleling due to the positive temperature coefficient of the on-state voltage
- Rugged XPT design (Xtreme light Punch Through) results in:
 - short circuit rated for 10 μ sec.
 - very low gate charge
 - low EMI
 - square RBSOA @ 3x I_c
- Thin wafer technology combined with the XPT design results in a competitive low $V_{CE(sat)}$
- SONIC™ diode
 - fast and soft reverse recovery
 - low operating forward voltage

Applications:

- Switched-mode power supplies
- Switched reluctance motor drive

Package: V1-A-Pack

- Isolation Voltage: 3600 V~
- Industry standard outline
- RoHS compliant
- Soldering pins for PCB mounting
- Height: 17 mm
- Base plate: DCB ceramic
- Reduced weight
- Advanced power cycling

Terms Conditions of usage:

The data contained in this product data sheet is exclusively intended for technically trained staff. The user will have to evaluate the suitability of the product for the intended application and the completeness of the product data with respect to his application. The specifications of our components may not be considered as an assurance of component characteristics. The information in the valid application- and assembly notes must be considered. Should you require product information in excess of the data given in this product data sheet or which concerns the specific application of your product, please contact the sales office, which is responsible for you.

Due to technical requirements our product may contain dangerous substances. For information on the types in question please contact the sales office, which is responsible for you.

Should you intend to use the product in aviation, in health or live endangering or life support applications, please notify. For any such application we urgently recommend

- to perform joint risk and quality assessments;

- the conclusion of quality agreements;

- to establish joint measures of an ongoing product survey, and that we may make delivery dependent on the realization of any such measures.

IGBT			Ratings			
Symbol	Definition	Conditions	min.	typ.	max.	Unit
V_{CES}	collector emitter voltage	$T_{VJ} = 25^{\circ}\text{C}$			1200	V
V_{GES}	max. DC gate voltage				± 20	V
V_{GEM}	max. transient gate emitter voltage				± 30	V
I_{C25}	collector current	$T_C = 25^{\circ}\text{C}$			220	A
I_{C80}		$T_C = 80^{\circ}\text{C}$			150	A
P_{tot}	total power dissipation	$T_C = 25^{\circ}\text{C}$			695	W
$V_{CE(sat)}$	collector emitter saturation voltage	$I_C = 150\text{A}; V_{GE} = 15\text{V}$			1,8	V
					2,1	V
$V_{GE(th)}$	gate emitter threshold voltage	$I_C = 6\text{mA}; V_{GE} = V_{CE}$	5,4	5,9	6,5	V
I_{CES}	collector emitter leakage current	$V_{CE} = V_{CES}; V_{GE} = 0\text{V}$			0,1	mA
					0,1	mA
I_{GES}	gate emitter leakage current	$V_{GE} = \pm 20\text{V}$			500	nA
$Q_{G(on)}$	total gate charge	$V_{CE} = 600\text{V}; V_{GE} = 15\text{V}; I_C = 150\text{A}$		470		nC
$t_{d(on)}$	turn-on delay time	inductive load $V_{CE} = 600\text{V}; I_C = 150\text{A}$ $V_{GE} = \pm 15\text{V}; R_G = 4,7\ \Omega$		70		ns
t_r	current rise time			40		ns
$t_{d(off)}$	turn-off delay time			250		ns
t_f	current fall time			100		ns
E_{on}	turn-on energy per pulse			14		mJ
E_{off}	turn-off energy per pulse			16		mJ
RBSOA	reverse bias safe operating area	$V_{GE} = \pm 15\text{V}; R_G = 4,7\ \Omega$				
I_{CM}		$V_{CEma} = 1200\text{V}$			450	A
SCSOA	short circuit safe operating area	$V_{CEma} = 1200\text{V}$				
t_{SC}	short circuit duration	$V_{CE} = 900\text{V}; V_{GE} = \pm 15\text{V}$			10	μs
I_{SC}	short circuit current	$R_G = 4,7\ \Omega; \text{non-repetitive}$		600		A
R_{thJC}	thermal resistance junction to case				0,18	K/W
R_{thCH}	thermal resistance case to heatsink			0,20		K/W
Diode						
V_{RRM}	max. repetitive reverse voltage	$T_{VJ} = 25^{\circ}\text{C}$			1200	V
I_{F25}	forward current	$T_C = 25^{\circ}\text{C}$			190	A
I_{F80}		$T_C = 80^{\circ}\text{C}$			130	A
V_F	forward voltage	$I_F = 150\text{A}$			2,20	V
					1,95	V
I_R	reverse current	$V_R = V_{RRM}$			0,3	mA
					0,8	mA
Q_{rr}	reverse recovery charge	$V_R = 600\text{V}$ $-di_F/dt = 2500\text{A}/\mu\text{s}$ $I_F = 150\text{A}; V_{GE} = 0\text{V}$		20		μC
I_{RM}	max. reverse recovery current			175		A
t_{rr}	reverse recovery time			350		ns
E_{rec}	reverse recovery energy			10		mJ
R_{thJC}	thermal resistance junction to case				0,28	K/W
R_{thCH}	thermal resistance case to heatsink			0,20		K/W

preliminary

Package V1-A-Pack		Ratings				
Symbol	Definition	Conditions	min.	typ.	max.	Unit
I_{RMS}	RMS current	per terminal			100	A
T_{VJ}	virtual junction temperature		-40		150	°C
T_{op}	operation temperature		-40		125	°C
T_{stg}	storage temperature		-40		125	°C
Weight				37		g
M_D	mounting torque		2		2,5	Nm
$d_{Spp/APP}$	creepage distance on surface / striking distance through air	terminal to terminal	6,0			mm
$d_{Spb/APb}$		terminal to backside	12,0			mm
V_{ISOL}	isolation voltage	t = 1 second	3600			V
		t = 1 minute	3000			V

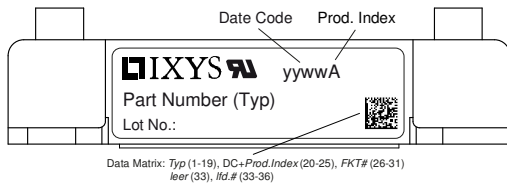

Part description

- M = Module
- I = IGBT
- X = XPT IGBT
- A = Gen 1 / std
- 150 = Current Rating [A]
- Q = Buck Chopper
- 1200 = Reverse Voltage [V]
- VA = V1-A-Pack

Ordering	Ordering Number	Marking on Product	Delivery Mode	Quantity	Code No.
Standard	MIXA150Q1200VA	MIXA150Q1200VA	Blister	24	512328

Equivalent Circuits for Simulation

* on die level

$T_{VJ} = 150\text{ °C}$

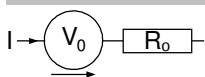

$V_{0\ max}$ threshold voltage

$R_{0\ max}$ slope resistance *

	IGBT	Diode	
$V_{0\ max}$	1,1	1,25	V
$R_{0\ max}$	9,2	5,7	mΩ

Outlines V1-A-Pack

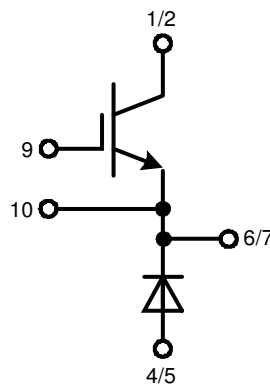
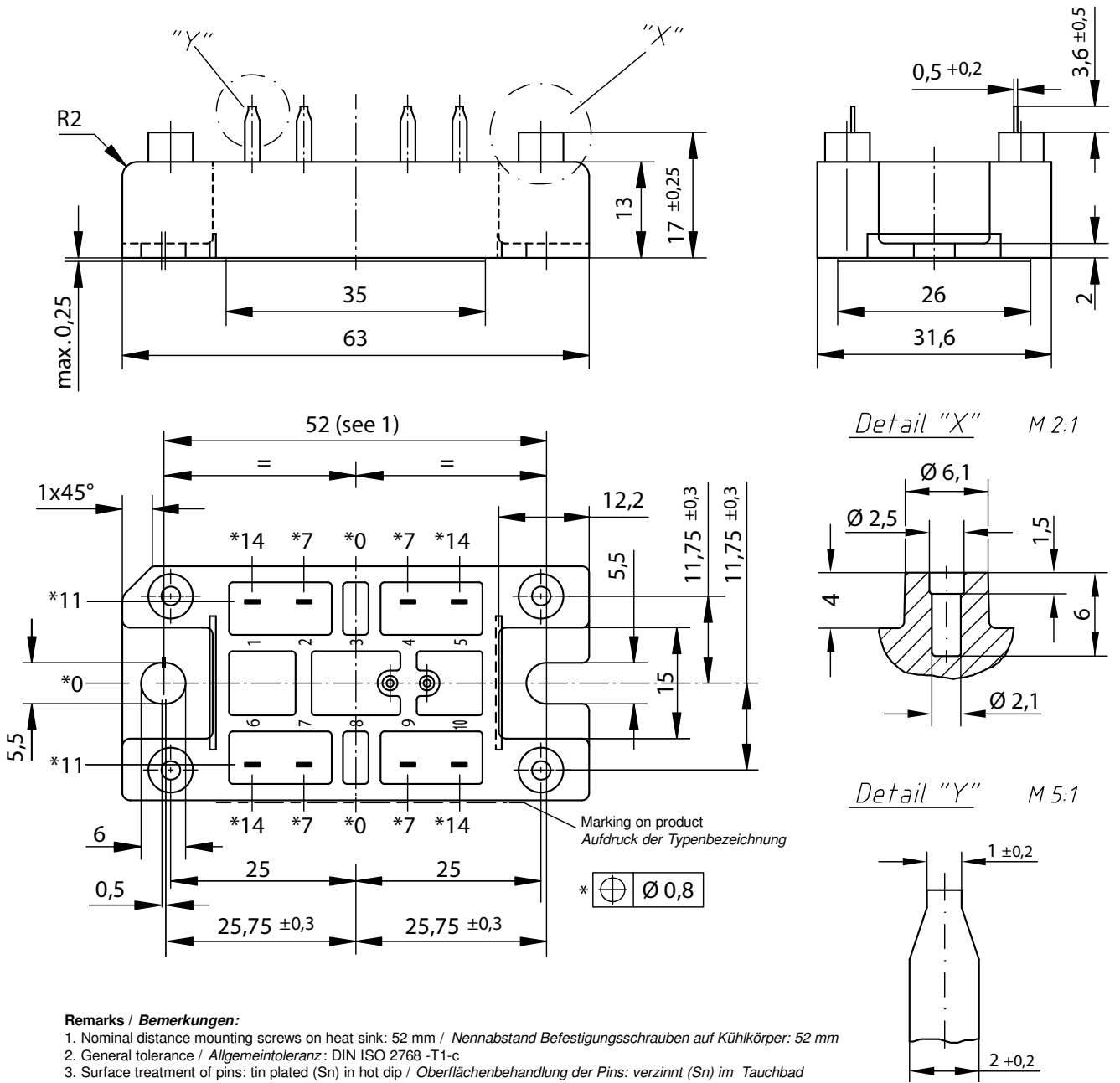

IGBT

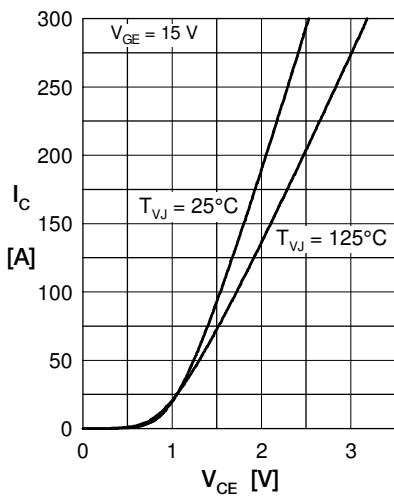

Fig. 1 Typ. output characteristics

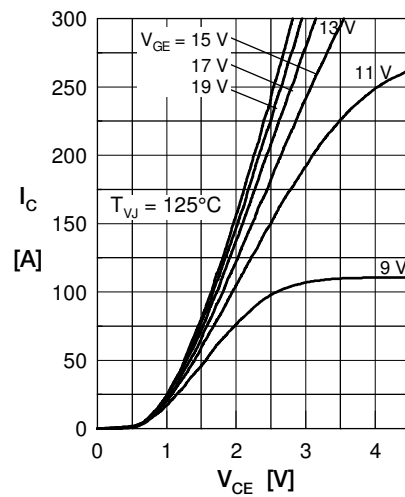

Fig. 2 Typ. output characteristics

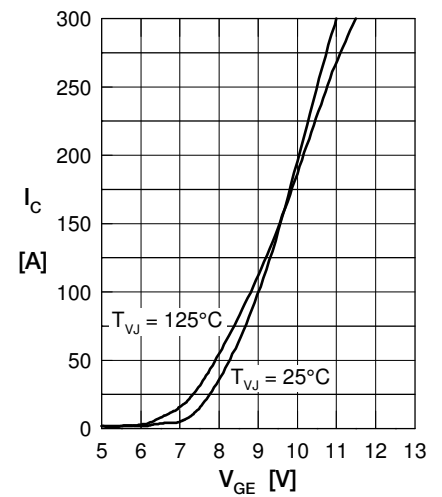

Fig. 3 Typ. transfer characteristics

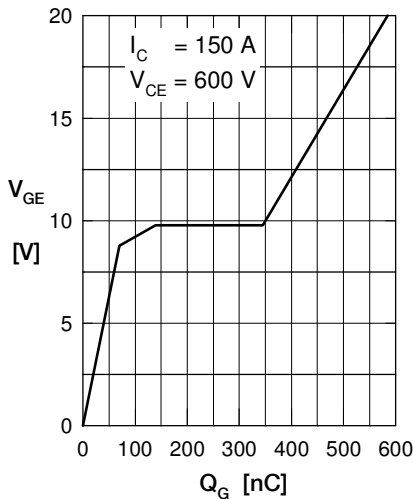

Fig. 4 Typ. turn-on gate charge

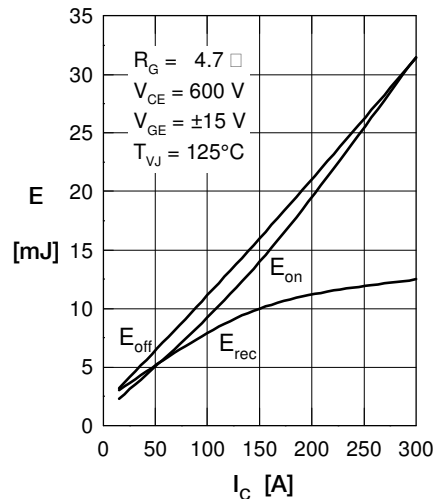

Fig. 5 Typ. switching energy versus collector current

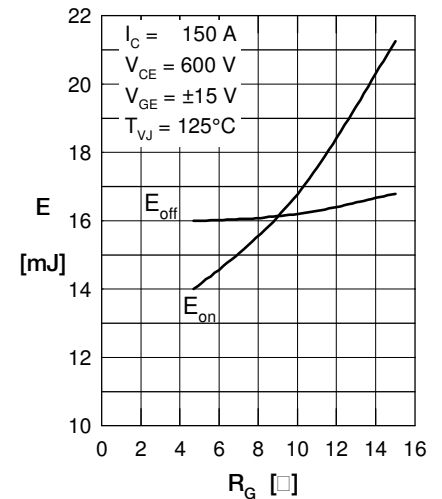

Fig. 6 Typ. switching energy versus gate resistance

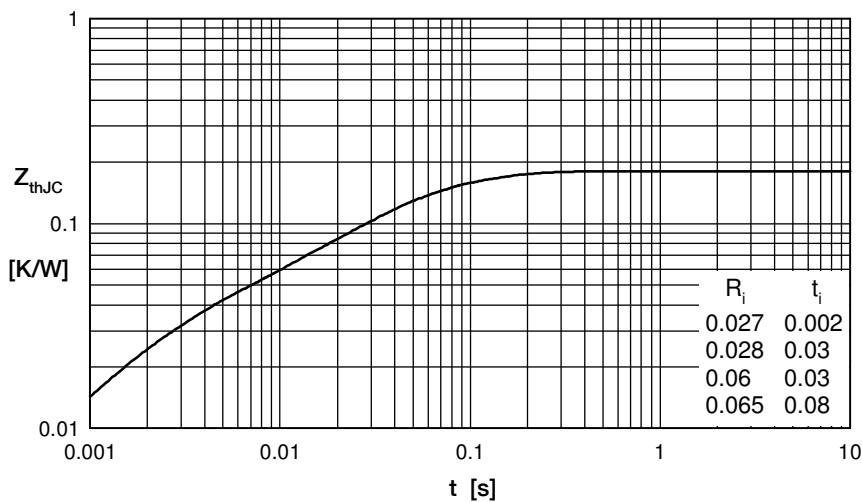

Fig. 7 Typ. transient thermal impedance

Diode

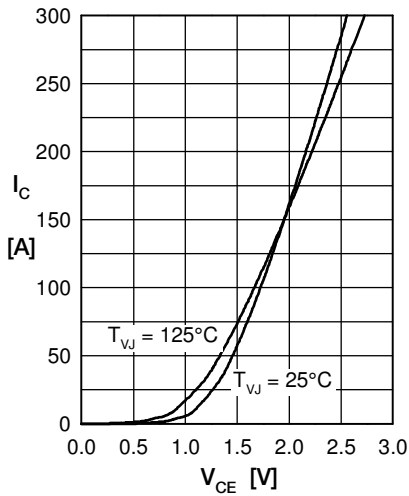

Fig. 1 Typ. Forward current versus V_F

Fig. 2 Typ. reverse recovery charge Q_{rr} versus di/dt

Fig. 3 Typ. peak reverse current I_{RM} versus di/dt

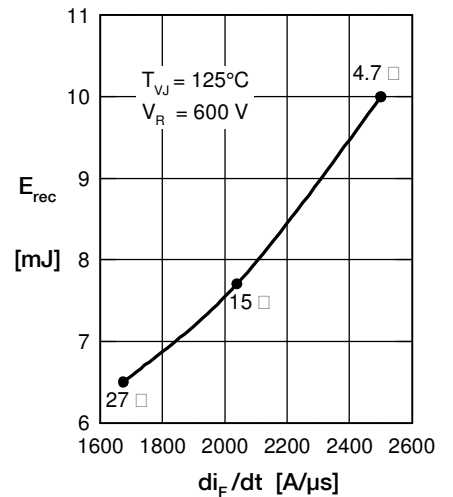

Fig. 4 Dynamic parameters Q_{rr} , I_{RM} versus T_{VJ}

Fig. 5 Typ. recovery time t_{rr} versus $-di_F/dt$

Fig. 6 Typ. recovery energy E_{rec} versus $-di/dt$

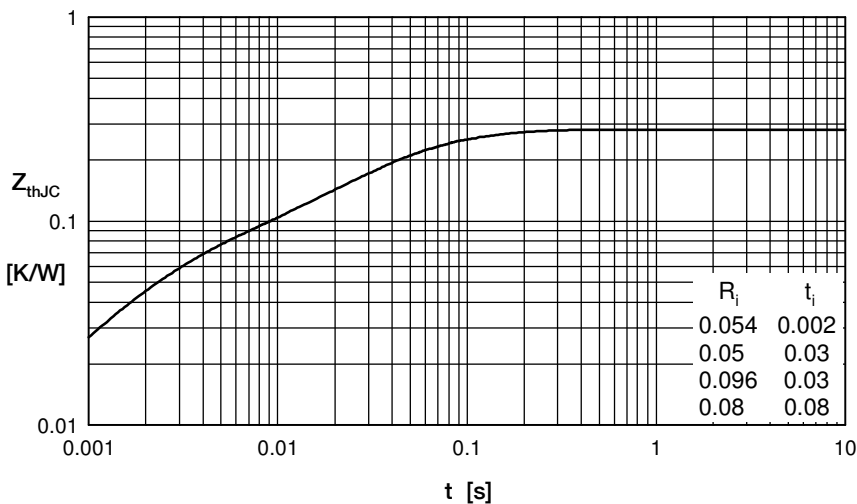

Fig. 7 Transient thermal impedance junction to case