

Alle Rechte vorbehalten/ All rights reserved

**Y
(Lochbild)
(board drillings)**

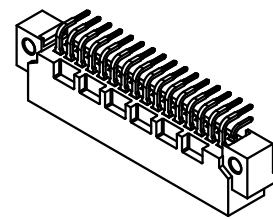

A-B
2:1

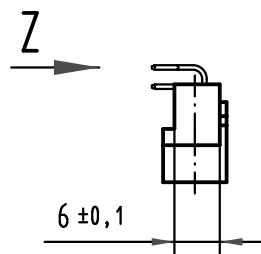
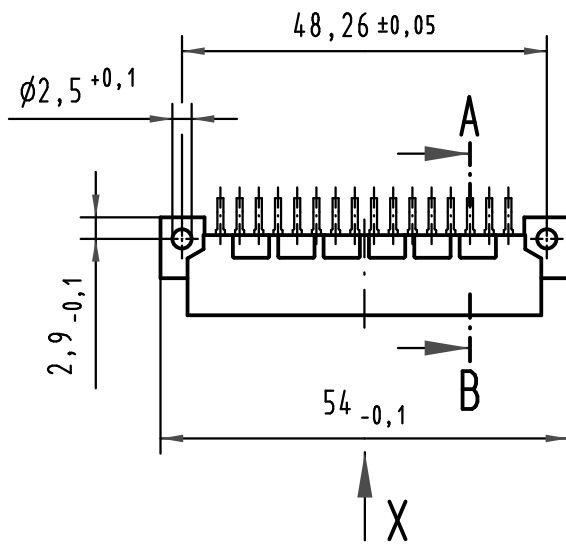
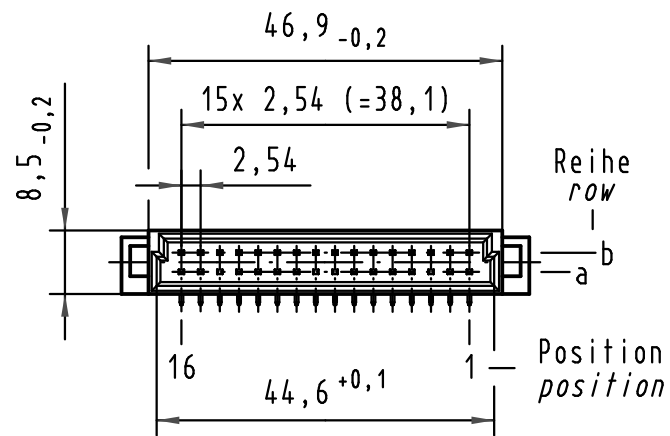
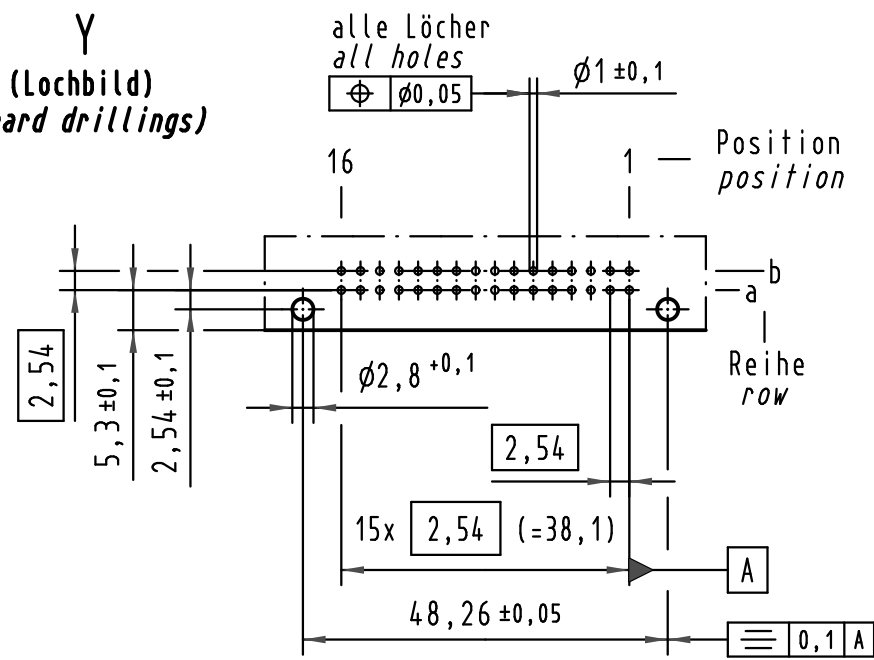
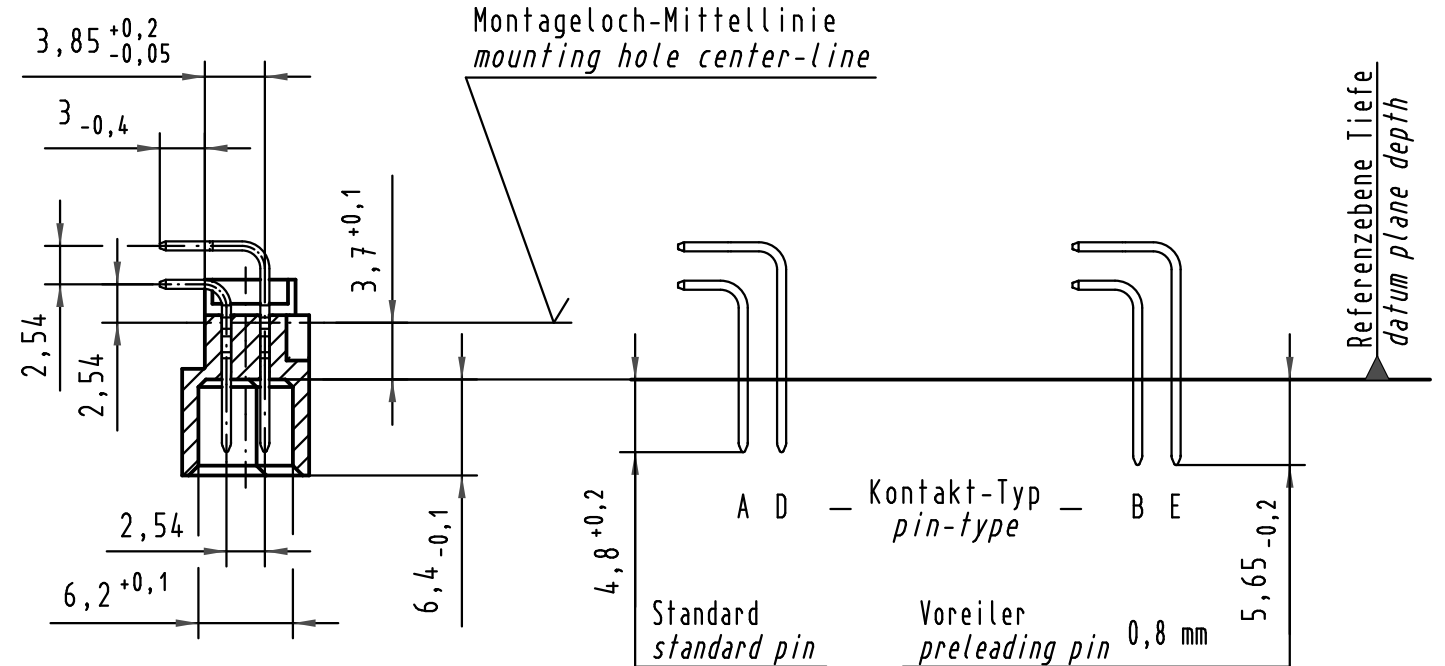

**X Kontaktbelegung
contact loading**



09 22 132 6919	2	Au flash over PdNi over Ni
Bestell-Nr. part-no.	Anforderungsstufe nach IEC performance level acc. to IEC	Kontaktoberfläche contact plating

Z
10:1

Querschnitt der
Lötanschlüsse:
cross-section of
solder terminations:

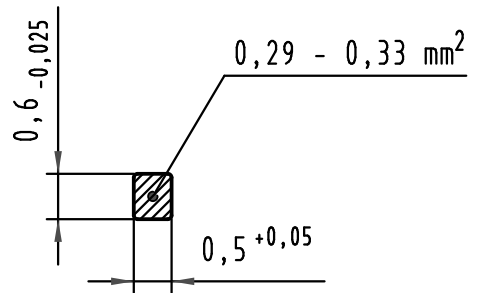

 All Dimensions in mm Original Size DIN A 3	Techn. Character.			Nicht tolerierte Maße/Free size tolerances IEC 60603-2		
		Dat.	Name	Maßstab/Scale	Bauform 2B Messerleiste Einlötl, 32 pol., SMC (Hochtemperatur) type 2B male connector solder, 32 pol., SMC (high temperature)	
	Detail.	28.08.09	Bus.			1:1
	Insp.	28.08.09	TD			2:1
Stand.			10:1			
35568	HARTING Electronics GmbH & Co. KG			 TB 09 22 132 x919	Blatt/page	
Mod.	Dat.	Name	D-32339 ESPELKAMP			Sub.