

# International IR Rectifier

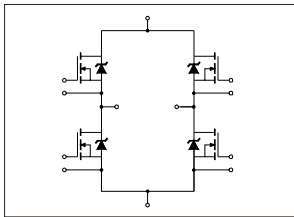
## 19MT050XF

### "FULL-BRIDGE" FREDFET MTP

### HEXFET® Power MOSFET

**Features**

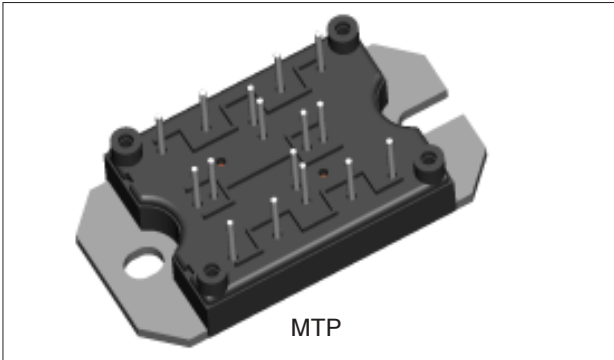
- Low On-Resistance
- High Performance Optimised Built-in Fast Recovery Diodes
- Fully Characterized Capacitance and Avalanche Voltage and Current
- Aluminum Nitride DBC
- Very Low Stray Inductance Design for High Speed Operation



**31 A**  
 $V_{DSS} = 500V$

**Benefits**

- Low Gate Charge Qg results in Simple Drive Requirement
- Improved Gate, Avalanche and Dynamic dv/dt Ruggedness
- Low Trr and Soft Diode Reverse Recovery
- Optimized for Welding, UPS and SMPS Applications
- Outstanding ZVS and High Frequency Operation
- Direct Mounting to Heatsink
- PCB Solderable Terminals
- Very Low Junction-to-Case Thermal Resistance
- UL Approved E78996



**Absolute Maximum Ratings**

Parameters		Max	Units
I <sub>D</sub>	Continuous Drain Current @ V <sub>GS</sub> = 10V	@ T <sub>C</sub> = 25°C	31
		@ T <sub>C</sub> = 100°C	19
I <sub>DM</sub>	Pulsed Drain Current (1)	124	A
P <sub>D</sub>	Maximum Power Dissipation	@ T <sub>C</sub> = 25°C	1140
		@ T <sub>C</sub> = 100°C	456
V <sub>GS</sub>	Gate-to-Source Voltage	± 30	V
V <sub>ISOL</sub>	RMS Isolation Voltage, Any Terminal to Case, t = 1 min	2500	
dv/dt	Peak Diode Recovery dv/dt (3)	15	V/ ns

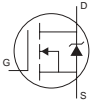
**Electrical Characteristics @  $T_J = 25^\circ\text{C}$  (unless otherwise specified)**

Parameters	Min	Typ	Max	Units	Test Conditions
$V_{(BR)DSS}$ Drain-to-Source Breakdown Voltage	500			V	$V_{GS} = 0V, I_D = 250\mu A$
$\Delta V_{(BR)DSS}/\Delta T_J$ Temperature Coeff. of Breakdown Voltage		0.48		V/ $^\circ\text{C}$	$I_D = 4mA$ , reference to $T_J = 25^\circ\text{C}$
$R_{DS(ON)}$ Static Drain-to-Source On-Resistance		0.19	0.22	$\Omega$	$V_{GS} = 10V, I_D = 19A$ (4)
		0.21	0.25		$V_{GS} = 10V, I_D = 31A$
$V_{GS(th)}$ Gate Threshold Voltage	3.0		6.0	V	$V_{DS} = V_{GS}, I_D = 250\mu A$
$I_{DSS}$ Drain-to-Source Leakage Current (6)			50	$\mu A$	$V_{DS} = 500V, V_{GS} = 0V$
			2	mA	$V_{DS} = 400V, V_{GS} = 0V, T_J = 125^\circ\text{C}$
$I_{GSS}$ Gate-to-Source Forward Leakage			150	nA	$V_{GS} = 30V$
Gate-to-Source Reverse Leakage			-150		$V_{GS} = -30V$

**Dynamic Characteristics @  $T_J = 25^\circ\text{C}$  (unless otherwise specified)**

Parameters	Min	Typ	Max	Units	Test Conditions
$g_{fs}$ Forward Transconductance		26		S	$V_{DS} = 50V, I_D = 19A$
$Q_g$ Total Gate Charge		105	160	nC	$I_D = 31A$
$Q_{gs}$ Gate-to-Source Charge		36	55		$V_{DS} = 400V$
$Q_{gd}$ Gate-to-Drain ("Miller") Charge		46	70		$V_{GS} = 10V$ (4)
$t_{d(on)}$ Turn-on Delay Time		49	74	ns	$I_D = 31A$
$t_{d(off)}$ Turn-off Delay Time		80	120		$V_{DS} = 250V$
$t_r$ Rise Time		165	250		$V_{GS} = 10V$
$t_f$ Fall Time		76	115		$R_G = 4.3\Omega$
$C_{iss}$ Input Capacitance		4808	7210	pF	$V_{GS} = 0V$
$C_{oss}$ Output Capacitance		1165	1750		$V_{DS} = 25V$
$C_{rss}$ Reverse Transfer Capacitance		40	60		$f = 1.0\text{ MHz}$

**Diode Characteristics @  $T_J = 25^\circ\text{C}$  (unless otherwise specified)**

Parameters	Min	Typ	Max	Units	Test Conditions
$I_S$ Continuous Source Current (Body Diode)			31	A	MOSFET symbol showing the integral reverse p-n junction diode 
$I_{SM}$ Pulsed Source Current (Body Diode) (1)			124		
$V_{SD}$ Diode Forward Voltage		1.01	1.1	V	$T_J = 25^\circ\text{C}, I_S = 31A, V_{GS} = 0V$ (4)
$t_{rr}$ Reverse Recovery Time		252	378	ns	$T_J = 125^\circ\text{C}, I_F = 31A$
$Q_{rr}$ Reverse Recovery Charge		1619	2428	nC	$di/dt = 100A/\mu s$ (4)

### Avalanche Characteristics

	Parameters	Min	Typ	Max	Units
E <sub>AS</sub>	Single Pulse Avalanche Energy (2)			493	mJ
I <sub>AR</sub>	Avalanche Current (1)			31	A
E <sub>AR</sub>	Repetitive Avalanche Energy (1)			114	mJ

### Thermal- Mechanical Specifications

	Parameters	Min	Typ	Max	Units
T <sub>J</sub>	Operating Junction Temperature Range	- 40		150	°C
T <sub>STG</sub>	Storage Temperature Range	- 40		125	
R <sub>thJC</sub>	Junction-to-Case (per MOSFET)			0.44	°C/ W
R <sub>thCS</sub>	Case-to-Sink (Heatsink Compound Thermal Conductivity = 1 W/mK)		0.06		
	Clearance <sup>(5)</sup> (external shortest distance in air between two terminals)	5.5			mm
	Creepage <sup>(5)</sup> (shortest distance along external surface of the insulating material between 2 terminals)	8			
	Weight		66		g

**Notes:**

- (1) Repetitive rating; pulse width limited by max. junction temperature  
 (2) Starting T<sub>J</sub> = 25°C, L = 1.0mH, R<sub>G</sub> = 25Ω  
 I<sub>AS</sub> = 31A

- (3) I<sub>SD</sub> ≤ 31A, di/dt ≤ 340 A/μs, V<sub>DD</sub> ≤ V<sub>(BR)DSS</sub>,  
 T<sub>J</sub> ≤ 150°C

- (4) Pulse width ≤ 400μs; duty cycle ≤ 2%

- (5) Standard version only i.e. without optional thermistor

- (6) I<sub>CES</sub> includes also opposite leg overall leakage

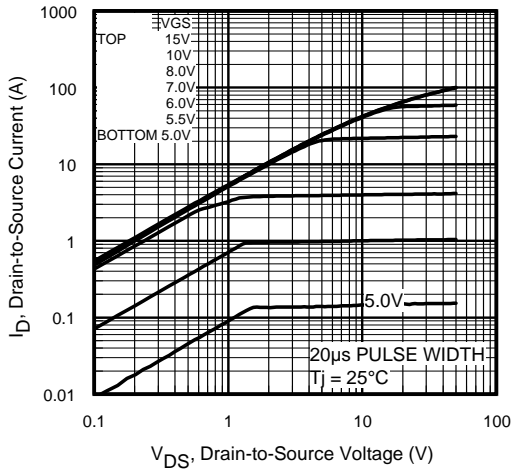


Fig 1. Typical Output Characteristics

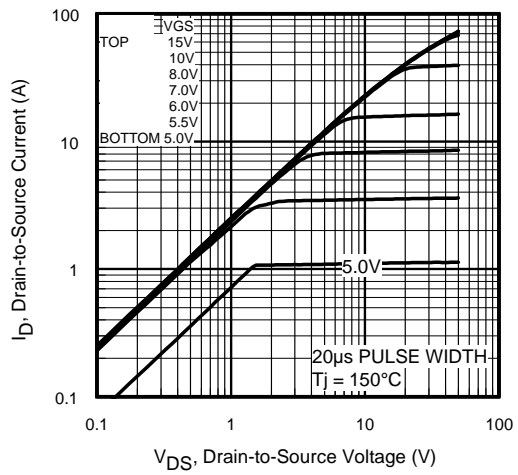


Fig 2. Typical Output Characteristics

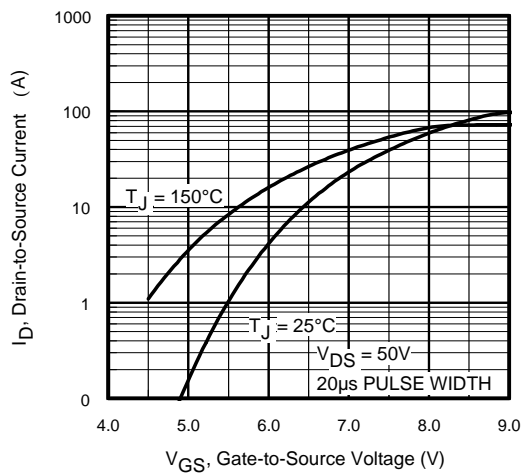


Fig 3. Typical Transfer Characteristics

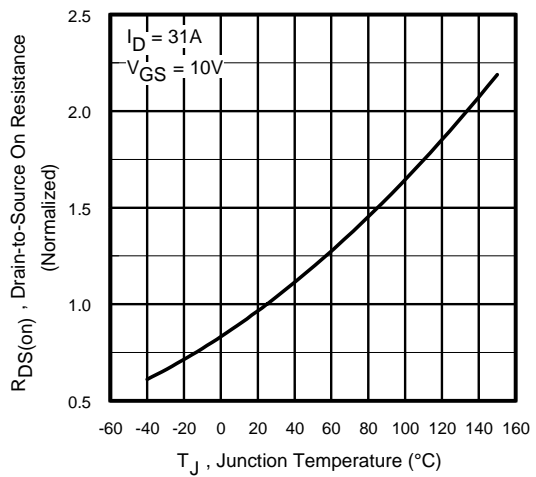


Fig 4. Normalized On-Resistance Vs. Temperature

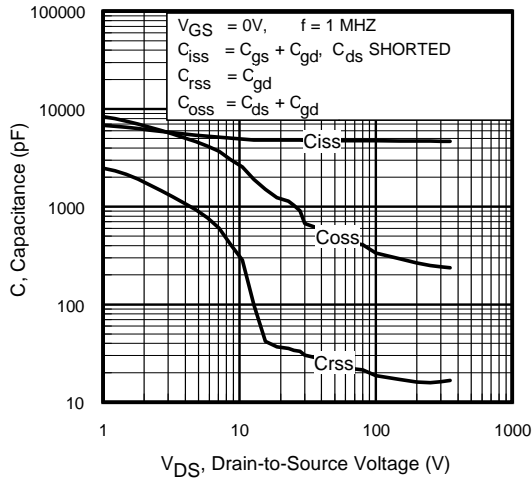


Fig 5. Typical Capacitance Vs. Drain-to-Source Voltage

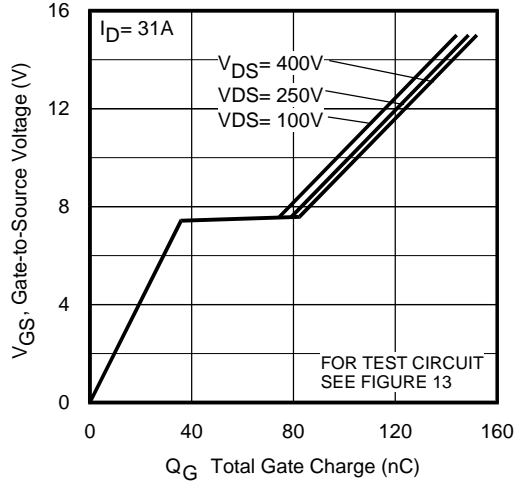


Fig 6. Typical Gate Charge Vs. Gate-to-Source Voltage

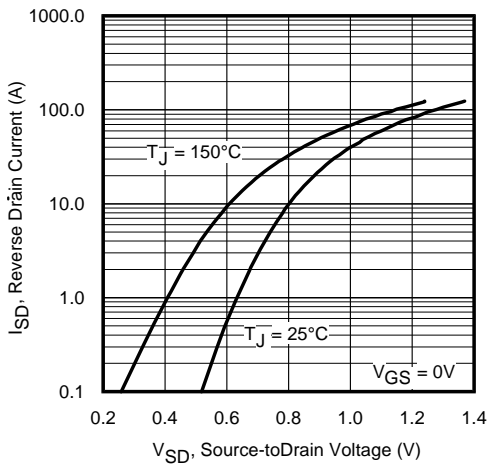


Fig 7. Typical Source-Drain Diode Forward Voltage

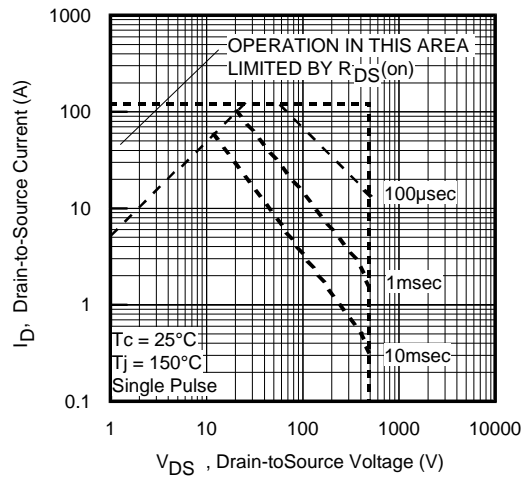


Fig 8. Maximum Safe Operating Area

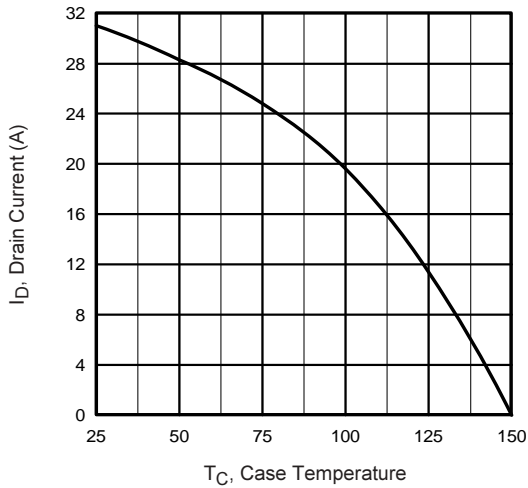


Fig 9. Maximum Drain Current Vs. Case Temperature

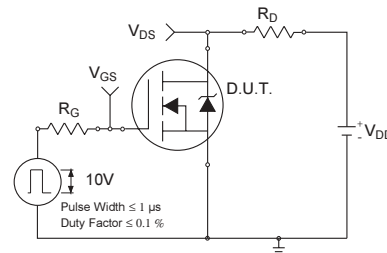


Fig 10a. Switching Time Test Circuit

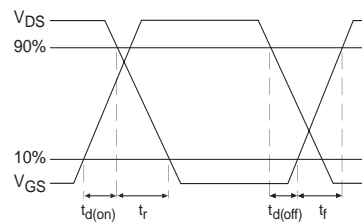


Fig 10b. Switching Time Waveforms

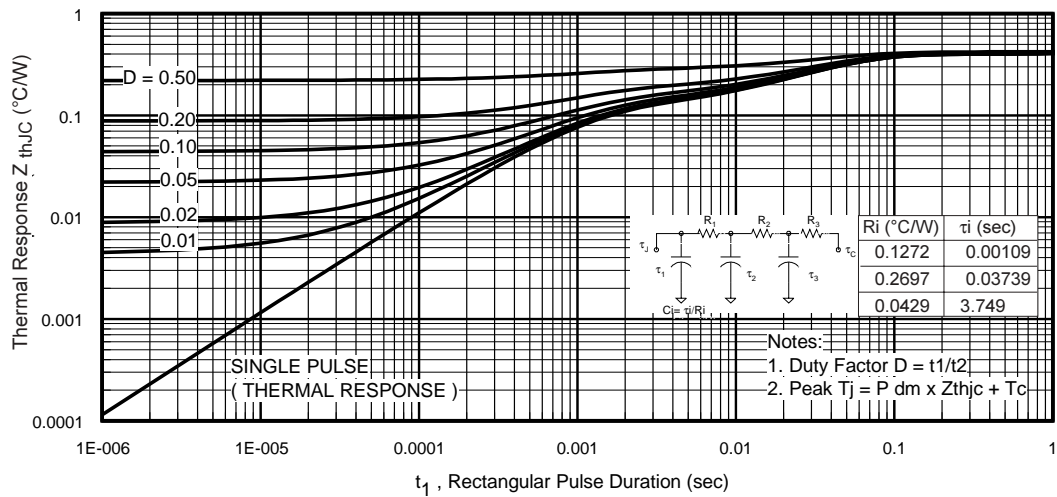
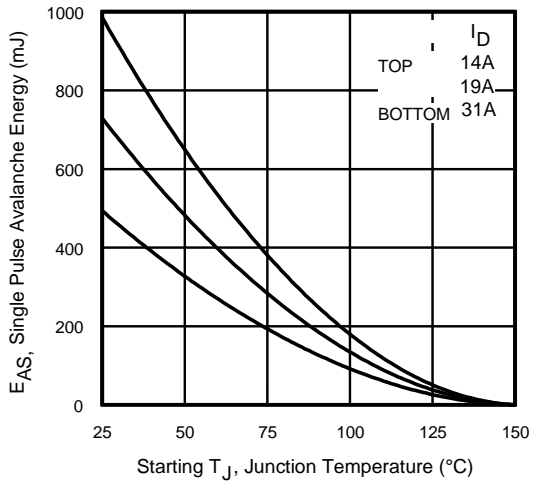
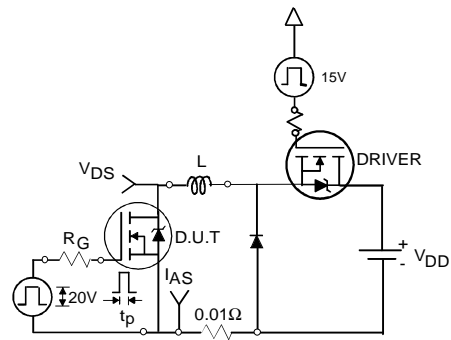


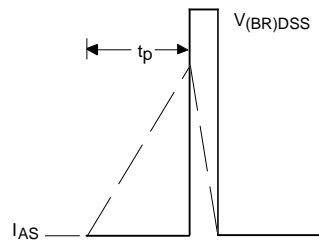
Fig 11. Maximum Effective Transient Thermal Impedance, Junction-to-Case



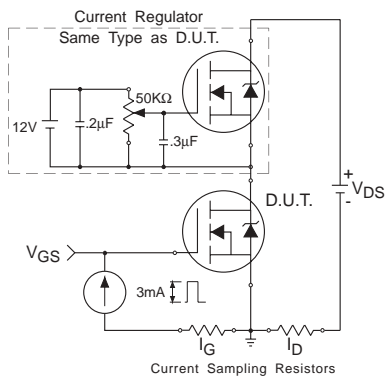
**Fig 12a.** Maximum Avalanche Energy Vs. Drain Current



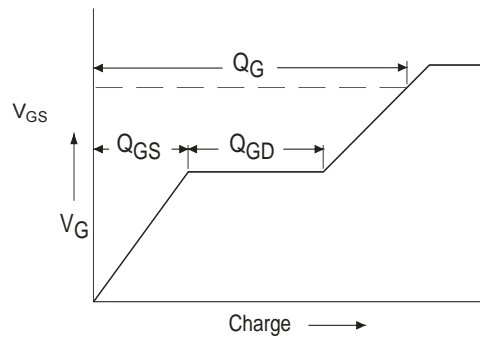
**Fig 12b.** Unclamped Inductive Test Circuit and vs Junction Temperature



**Fig 12c.** Unclamped Inductive Waveforms

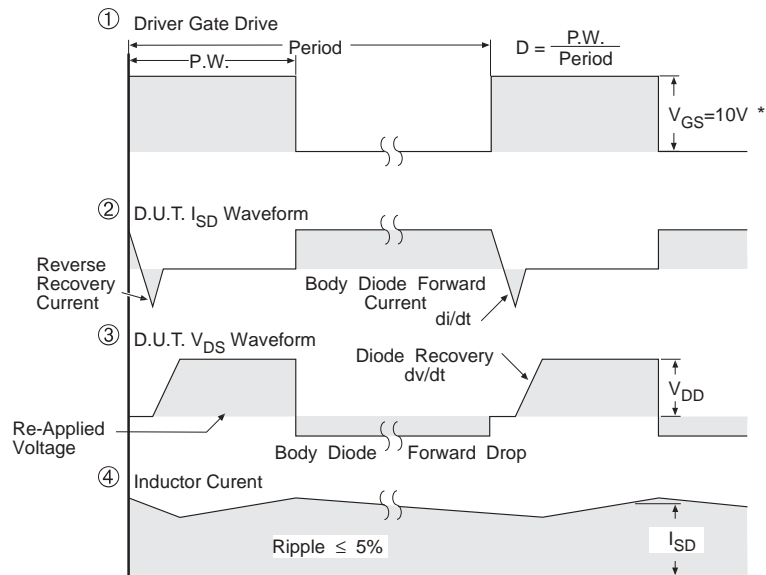
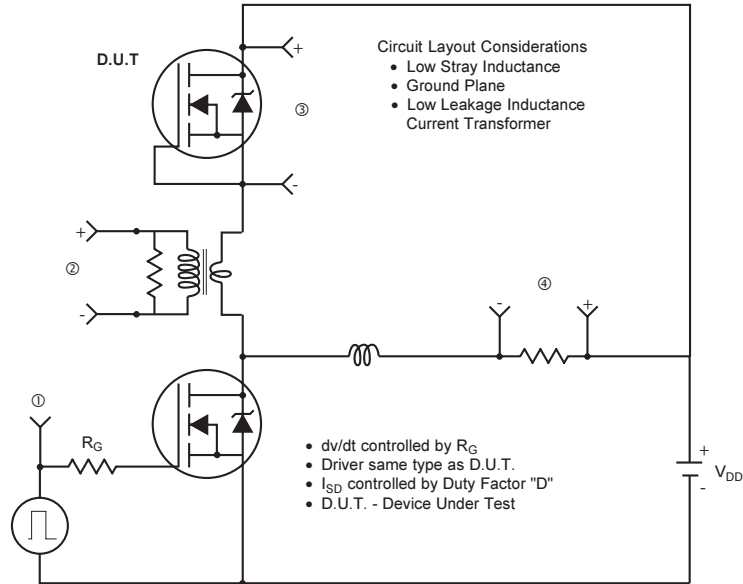


**Fig 13a.** Gate Charge Test Circuit



**Fig 13b.** Basic Gate Charge Waveform

**Peak Diode Recovery dv/dt Test Circuit**

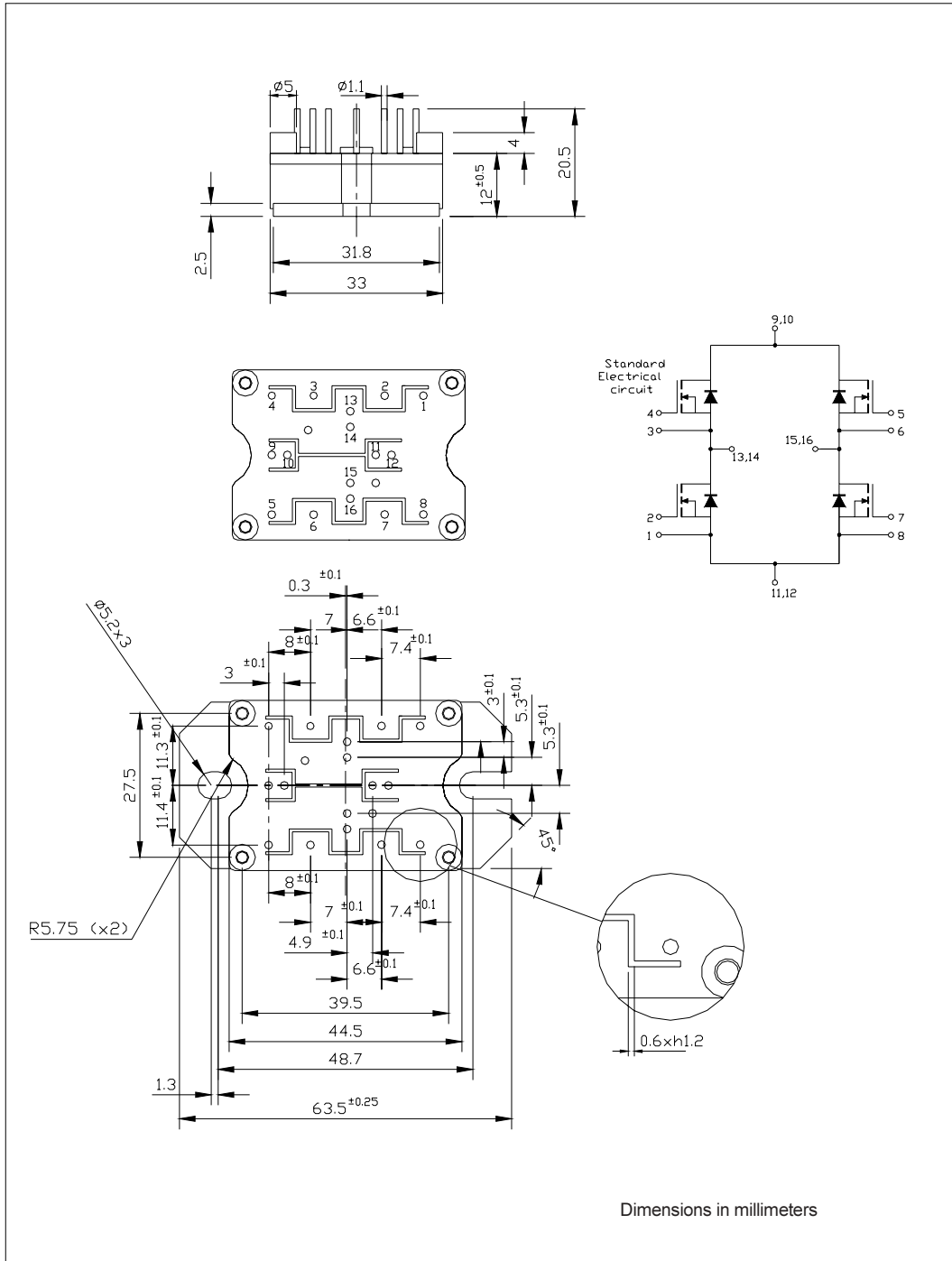


\*  $V_{GS} = 5V$  for Logic Level Devices

**Fig 14.** For N-Channel HEXFET® Power MOSFETs



**Outline Table**



**Ordering Information Table**

Device Code	
<b>19</b>	<b>MT</b>
①	②
<b>050</b>	<b>X</b>
③	④
<b>F</b>	⑤
<b>1</b>	- Current rating (19 = 19A)
<b>2</b>	- Essential Part Number
<b>3</b>	- Voltage code (050 = 500V)
<b>4</b>	- Speed/ Type (X = HexFet)
<b>5</b>	- Circuit Configuration (F = Full Bridge)

Data and specifications subject to change without notice.  
 This product has been designed and qualified for Industrial Level.  
 Qualification Standards can be found on IR's Web site.

International  
**IR** Rectifier

**IR WORLD HEADQUARTERS:** 233 Kansas St., El Segundo, California 90245, USA Tel: (310) 252-7105  
 TAC Fax: (310) 252-7309

Visit us at [www.irf.com](http://www.irf.com) for sales contact information. 09/02