

PART No. 1418N4SSS10
 for more information visit
www.hamfmg.com
 Data subject to change without notice
 Isometric drawing Not to Scale

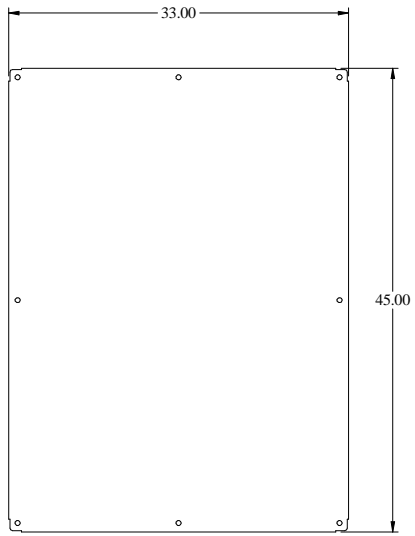

INNER PANEL

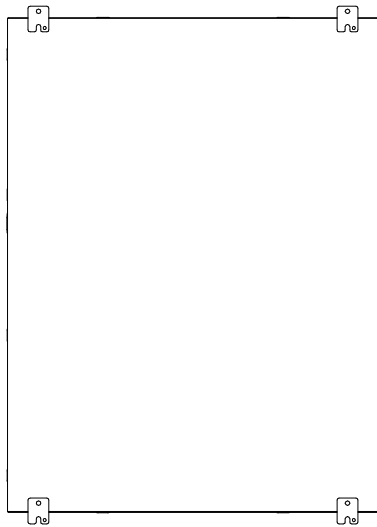

BACK VIEW

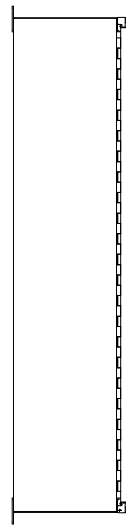

SIDE VIEW

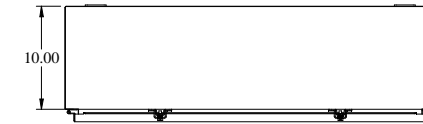

TOP VIEW

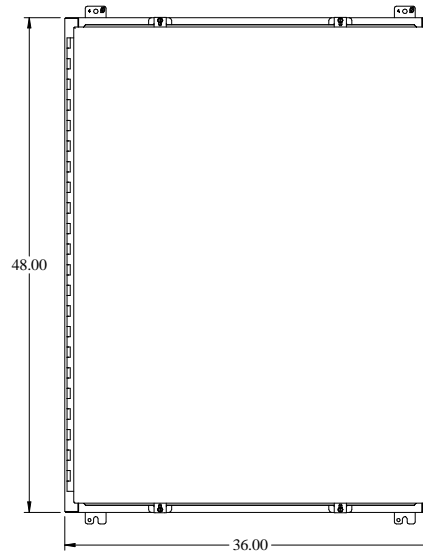

FRONT VIEW

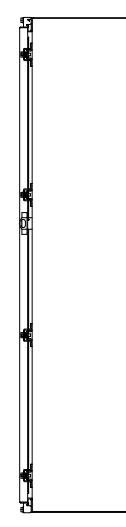

SIDE VIEW

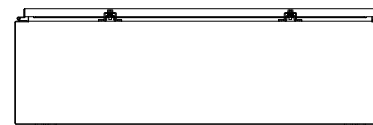

BOTTOM VIEW

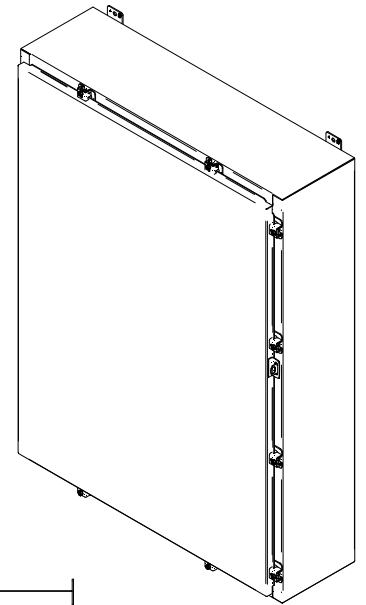

ISOMETRIC VIEW