

DISTINCTIVE CHARACTERISTICS

- Expansion of FT Series with more universal options include wider, larger and narrow frame types
- Construction of film and glass with superior durability and flexibility
- Choice of input methods: finger or stylus
- Wide range of panel sizes in analog includes 5.7", 6.5", 8.4", 10.4", 10.6", 12.1", 15", 15.6" and 19"
- Anti-Newton Ring (ANR) Technology eliminates many of the typical visual artifacts for analog types
- Operator can easily direct the device without specialized technical training or computer knowledge by combining touch screen to LCD panel, plasma EL or other display
- Touch screens support flexible design, including digital and analog, in a variety of sizes and relatively low cost
- Anti-glare surface reduces reflection from fluorescent lighting, sunlight, etc.
- Adhesive layer between glass and film has improved durability to withstand diverse environmental conditions
- Hard resin coating on film's surface ensures excellent protection against scratches or damage



APPLICATIONS

- Office Automation
- Medical Equipment
- Industrial Automation
- Broadcast
- Information Technology
- Hospitality
- Banking Systems
- Gaming/Entertainment

Cross Section View of Touch Screen

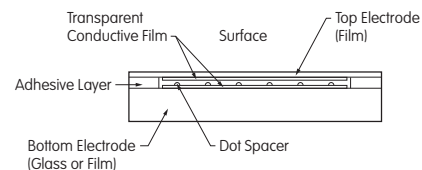

Specializing in Custom Products

- Custom sizes for Resistive Touch Screens
- Capability to attach touch screens to LCDs or other components
- Specializing in custom construction such as film plus film combinations
- Fingerprint resistant, high transmittance films
- Availability of metallic tails (i.e., copper pattern plus gold plate)

Control Board for Analog Touch Panels

- Combining an analog touch panel with a controller board device driver on a computer enables performing the same operations as with a mouse by touching the touch panel screen
- NKK offers controller boards compatible with USB or with RS232C

TYPICAL TOUCH SCREEN ORDERING EXAMPLE

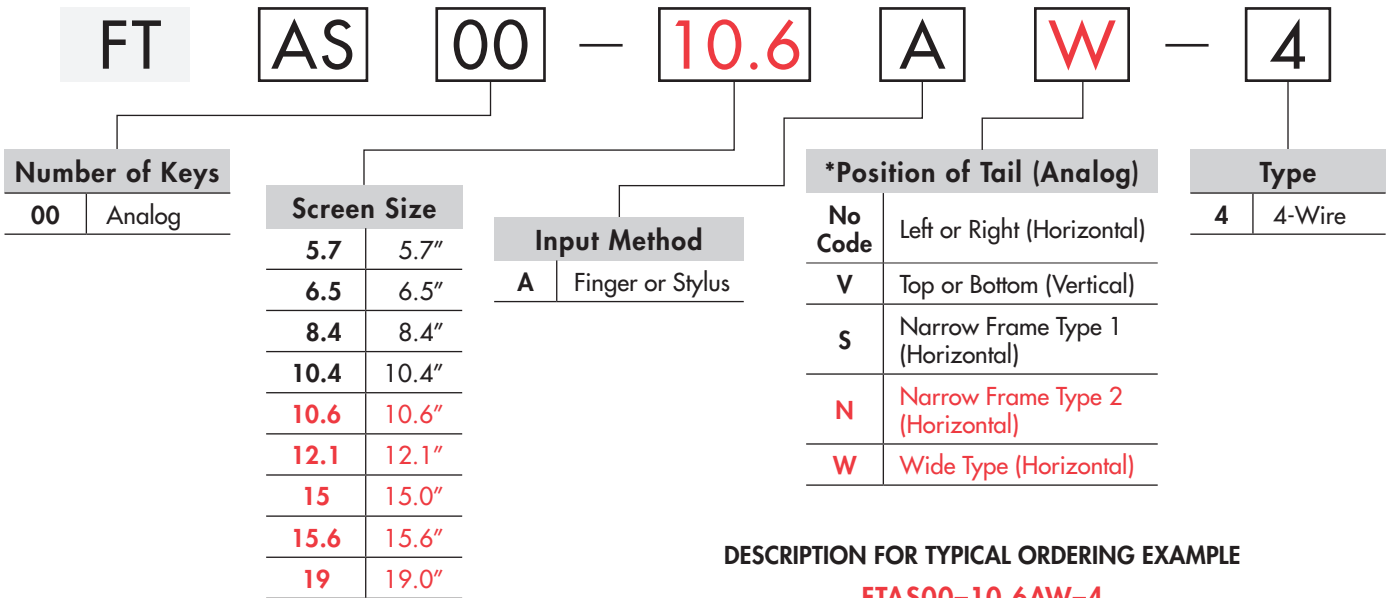

DESCRIPTION FOR TYPICAL ORDERING EXAMPLE

FTAS00-10.6AW-4







* Aspect Ratio:
Narrow Frame: 4:3
Wide Frame: 16:9



GENERAL SPECIFICATIONS

4-Wire Analog Resistive Touch Screens	
Power Level	1mA @ 5V DC (resistive load)
XY Resistive Value	Narrow: 250 ~ 850Ω Wide: 120 ~ 1,500Ω
Linearity	±1.5% maximum
Insulation Impedance	10MΩ minimum @ 25V DC
Expected Operational Life	Writing: 50,000 operations minimum (approximately 30mm movement with stylus)
	Tapping: 1,000,000 operations minimum (pressing force 4.9N using silicone rubber, hardness 60°)
Touch Activation Force	1.47N maximum
Chattering Time	10 milliseconds maximum
Relative Humidity	+60°C (+140°F), humidity 90%, 240 hours
Operating Temperature Range	-20°C ~ +70°C (-4°F ~ +158°F)
Storage Temperature Range	-40°C ~ +80°C (-40°F ~ +176°F)
Light Transmission	80% standard (Touch Panel portion)
Surface Hardness	2H minimum (JIS K5600)

PART NUMBERS & DESCRIPTIONS

 <p>FTAS00-12.1AN-4</p>	 <p>FTAS00-15AN-4</p>	 <p>FTAS00-19AN-4</p>
 <p>FTAS00-10.6AW-4</p>	 <p>FTAS00-12.1AW-4</p>	 <p>FTAS00-15.6AW-4</p>

4-Wire Analog Touch Screens

Part Number	Screen Size in Inches	Key Area Dimensions	Viewing Area Dimensions	External Dimensions	Panel Thickness	Terminal Detail 8 Pin .049" (1.25mm) Pitch
FTAS00-12.1AN-4	12.1	9.677" x 7.256" (245.8mm x 184.3mm)	9.827" x 7.406" (249.6mm x 188.1mm)	10.236" x 7.795" (260.0mm x 198.0mm)	.083" (2.1mm)	Length 3.150" (80.0mm)
FTAS00-15AN-4	15.0	11.972" x 8.980" (304.1mm x 228.1mm)	12.130" x 9.138" (308.1mm x 232.1mm)	12.669" x 9.665" (321.8mm x 245.5mm)	.083" (2.1mm)	Length 3.150" (80.0mm)
FTAS00-19AN-4	19.0	14.815" x 11.850" (376.3mm x 301.0mm)	15.039" x 12.102" (382.0mm x 307.4mm)	15.571" x 12.638" (395.5mm x 321.0mm)	.083" (2.1mm)	Length 3.150" (80.0mm)
FTAS00-10.6AW-4	10.6	9.071" x 5.441" (230.4mm x 138.2mm)	9.189" x 5.563" (233.4mm x 141.3mm)	9.756" x 6.094" (247.8mm x 154.8mm)	.083" (2.1mm)	Length 3.150" (80.0mm)
FTAS00-12.1AW-4	12.1	10.280" x 6.425" (261.12mm x 163.2mm)	10.404" x 6.551" (264.26mm x 166.4mm)	10.827" x 6.929" (275.0mm x 176.0mm)	.083" (2.1mm)	Length 3.150" (80.0mm)
FTAS00-15.6AW-4	15.6	13.551" x 7.618" (344.2mm x 193.5mm)	13.681" x 7.748" (347.5mm x 196.8mm)	14.276" x 8.433" (362.6mm x 214.2mm)	.083" (2.1mm)	Length 3.150" (80.0mm)

TYPICAL 12.1 DIMENSIONS

4-Wire with Horizontal Tail & Narrow Frame

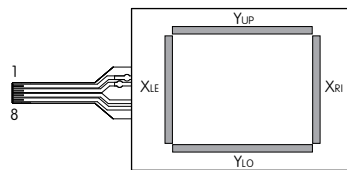
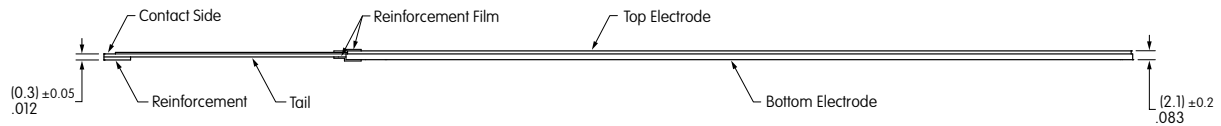
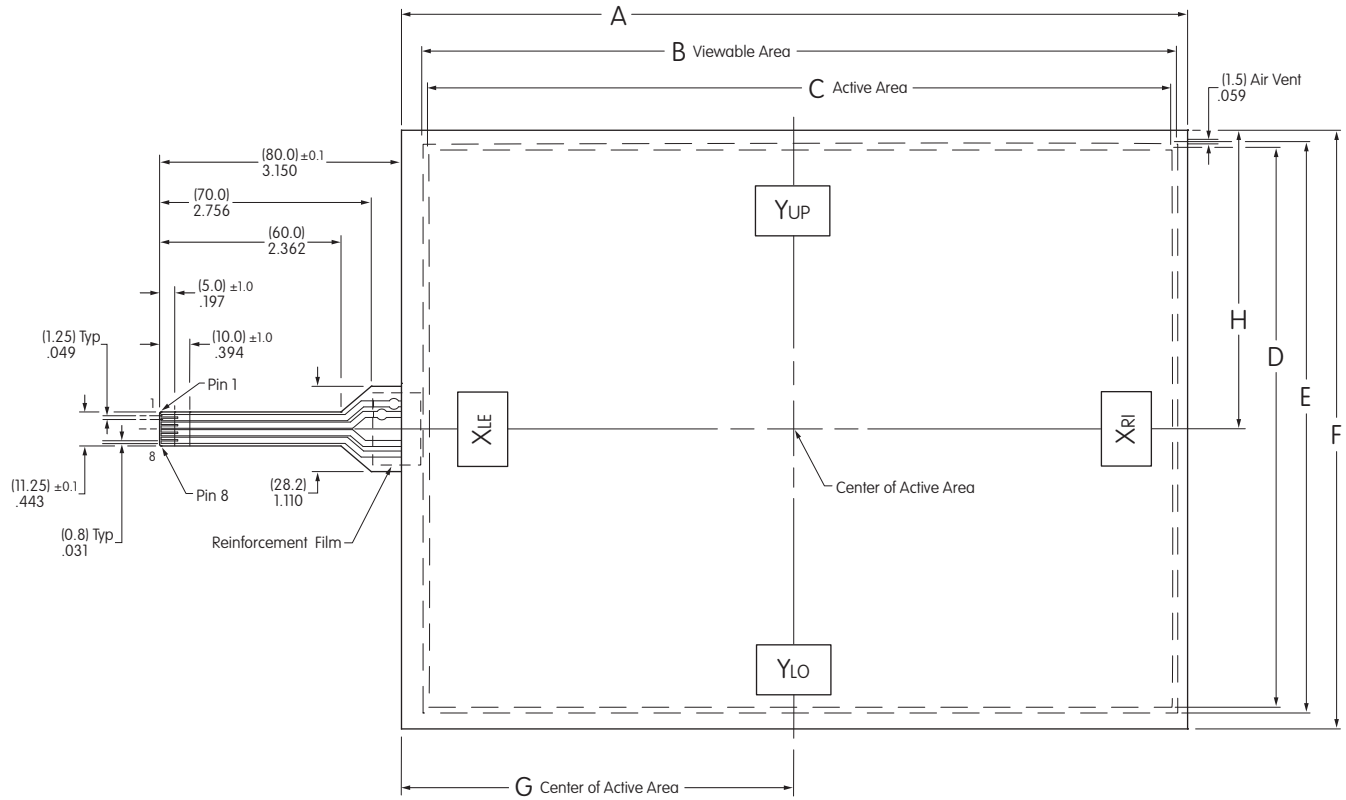

Y_{UP}, Y_{LO}: Top Electrode Terminal
X_{LE}, X_{RI}: Bottom Electrode Terminal

Pins	Signal
1, 2	Y _{UP}
3, 4	Y _{LO}
5, 6	X _{LE}
7, 8	X _{RI}

Typical Dimensions

Part Number	Screen Size in Inches	Dim A	Dim B Viewable Area	Dim C Active Area	Dim D Active Area	Dim E Viewable Area	Dim F	Dim G Center of Active Area (Horizontal)	Dim H Center of Active Area (Vertical)
FTAS00-12.1AN-4	12.1	10.236" (260.±0.3mm)	9.827" (249.6mm)	9.677" (245.8mm)	7.256" (184.3mm)	7.406" (188.1mm)	7.795" (198.±0.3mm)	5.177" (131.5mm)	3.850" (97.8mm)

TYPICAL 15.0 DIMENSIONS

4-Wire with Horizontal Tail & Narrow Frame

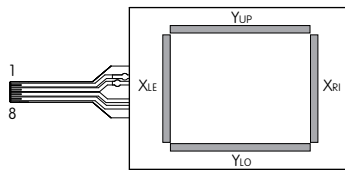
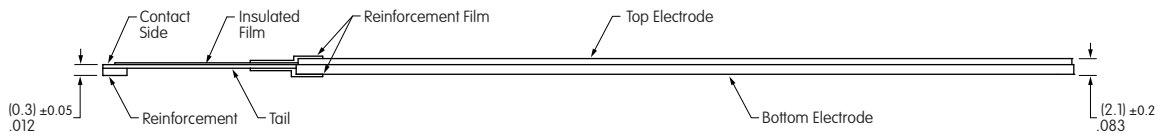
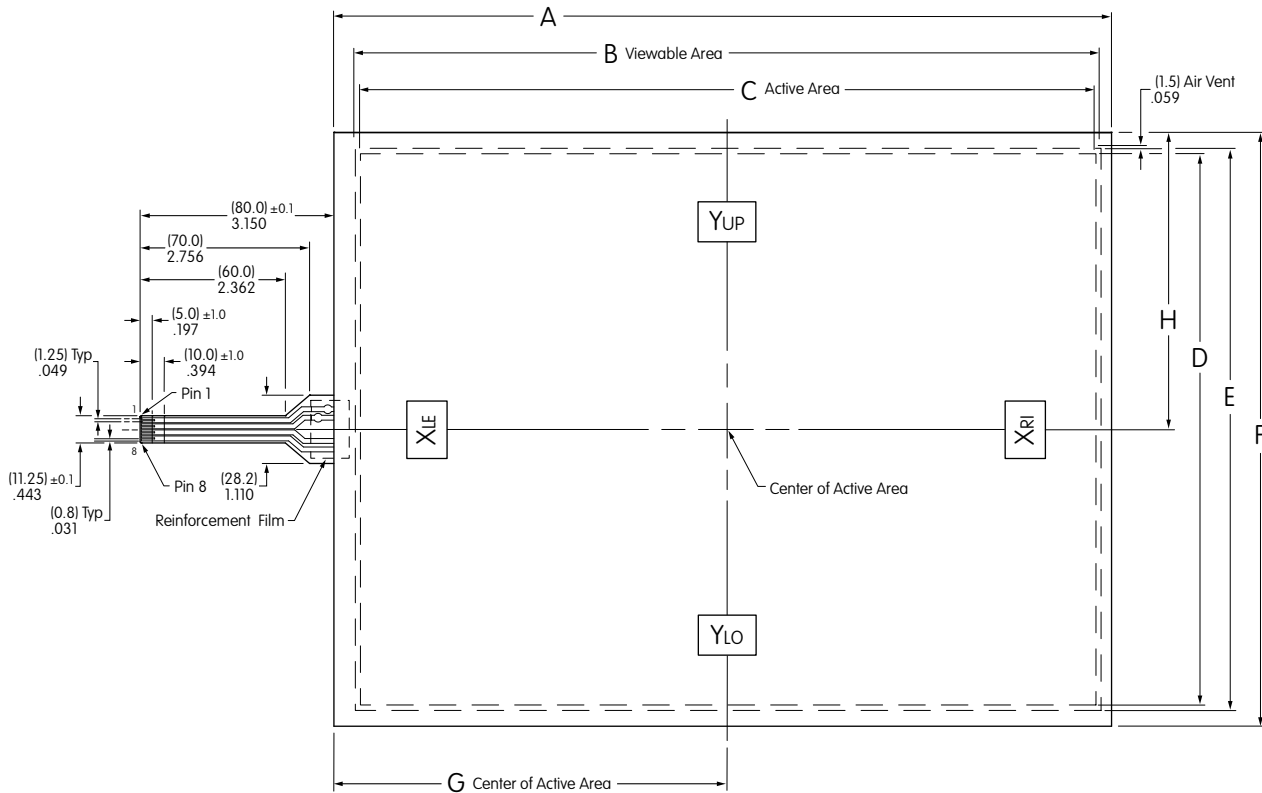

Y_{UP}, Y_{LO}: Top Electrode Terminal
X_{LE}, X_{RI}: Bottom Electrode Terminal

Pins	Signal
1, 2	Y _{UP}
3, 4	Y _{LO}
5, 6	X _{LE}
7, 8	X _{RI}

Typical Dimensions

Part Number	Screen Size in Inches	Dim A	Dim B Viewable Area	Dim C Active Area	Dim D Active Area	Dim E Viewable Area	Dim F	Dim G Center of Active Area (Horizontal)	Dim H Center of Active Area (Vertical)
FTAS00-15AN-4	15.0	12.669" (321.8.±0.3mm)	12.130" (308.1mm)	11.972" (304.1mm)	8.980" (228.1mm)	9.138" (232.1mm)	9.665" (245.5±0.3mm)	6.398" (162.5mm)	4.833" (122.75mm)

TYPICAL 19.0 DIMENSIONS

4-Wire with Horizontal Tail & Narrow Frame

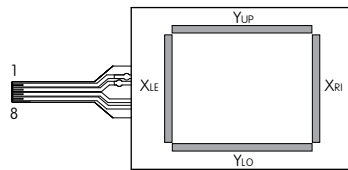
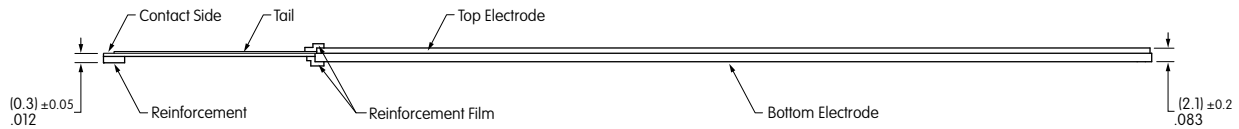
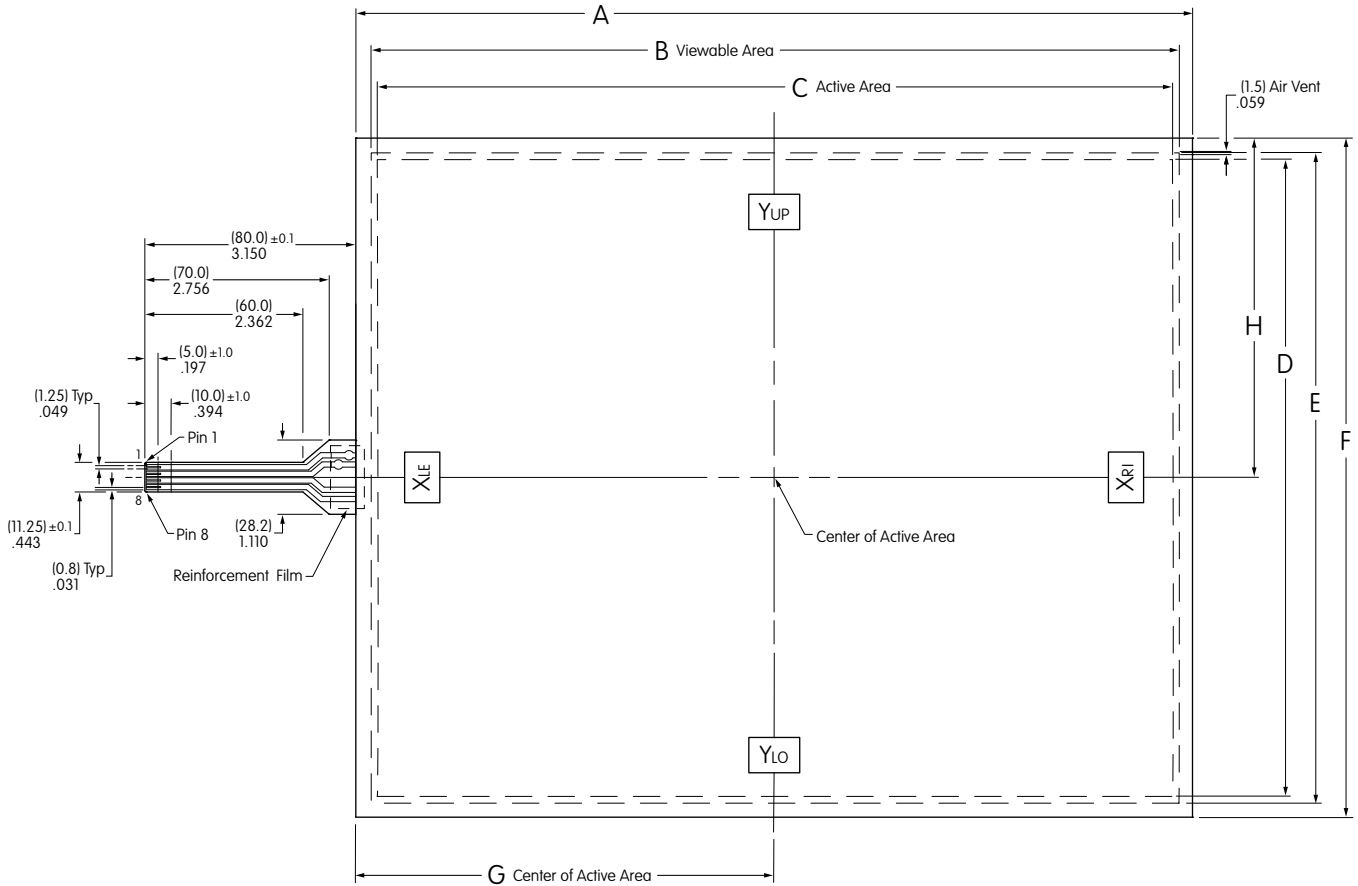

YUP, YLO: Top Electrode Terminal
XLE, XRI: Bottom Electrode Terminal

Pins	Signal
1, 2	YUP
3, 4	YLO
5, 6	XLE
7, 8	XRI

Typical Dimensions

Part Number	Screen Size in Inches	Dim A	Dim B Viewable Area	Dim C Active Area	Dim D Active Area	Dim E Viewable Area	Dim F	Dim G Center of Active Area (Horizontal)	Dim H Center of Active Area (Vertical)
FTAS00-19AN-4	19.0	15.571" (395.5 ± 0.3mm)	15.039" (382.0mm)	14.815" (376.3mm)	11.850" (301.0mm)	12.102" (307.4mm)	12.638" (321.0 ± 0.3mm)	7.799" (198.1mm)	6.319" (160.5mm)

TYPICAL 10.6 DIMENSIONS

4-Wire with Horizontal Tail & Wide Frame

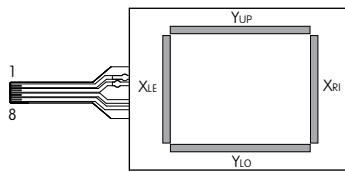
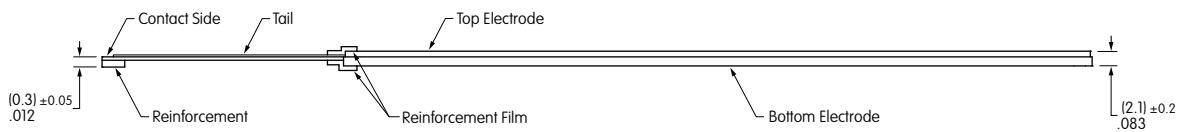
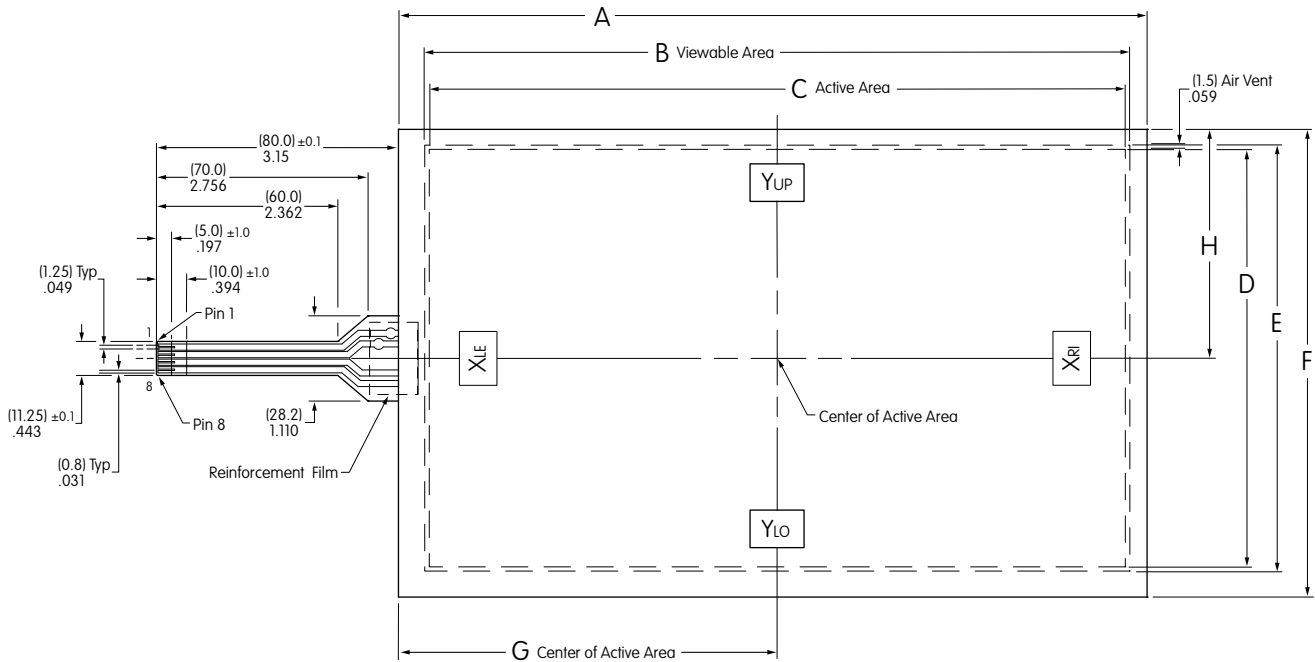

Y_{UP}, Y_{LO}: Top Electrode Terminal
X_{LE}, X_{RI}: Bottom Electrode Terminal

Pins	Signal
1, 2	Y _{UP}
3, 4	Y _{LO}
5, 6	X _{LE}
7, 8	X _{RI}

Typical Dimensions

Part Number	Screen Size in Inches	Dim A	Dim B Viewable Area	Dim C Active Area	Dim D Active Area	Dim E Viewable Area	Dim F	Dim G Center of Active Area (Horizontal)	Dim H Center of Active Area (Vertical)
FTAS00-10.6AW-4	10.6	9.756" (247.8±0.3mm)	9.189" (233.4mm)	9.071" (230.4mm)	5.441" (138.2mm)	5.563" (141.3mm)	6.094" (154.8±0.3mm)	4.933" (125.3mm)	2.984" (75.8mm)

TYPICAL 12.1 DIMENSIONS

4-Wire with Horizontal Tail & Wide Frame

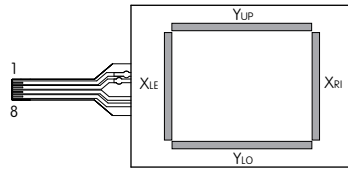
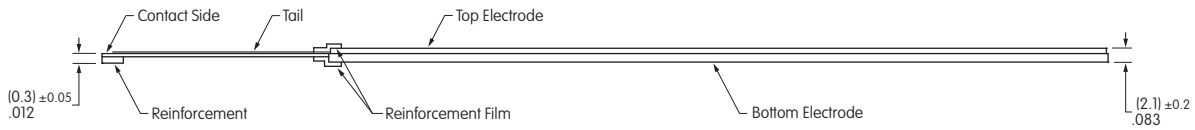
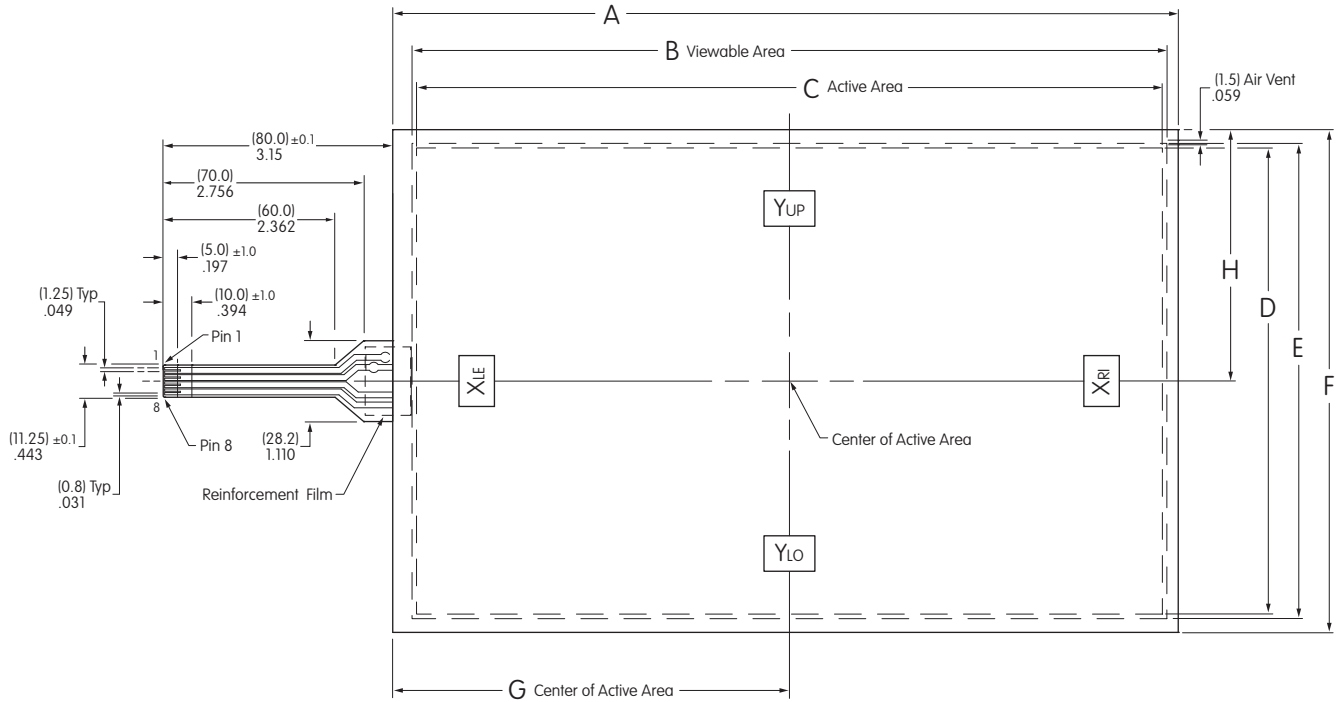

Y_{UP}, Y_{LO}: Top Electrode Terminal
X_{LE}, X_{RI}: Bottom Electrode Terminal

Pins	Signal
1, 2	Y _{UP}
3, 4	Y _{LO}
5, 6	X _{LE}
7, 8	X _{RI}

Typical Dimensions

Part Number	Screen Size in Inches	Dim A	Dim B Viewable Area	Dim C Active Area	Dim D Active Area	Dim E Viewable Area	Dim F	Dim G Center of Active Area (Horizontal)	Dim H Center of Active Area (Vertical)
FTAS00-12.1AW-4	12.1	10.827" (275.0±0.3mm)	10.404" (264.26mm)	10.280" (261.12mm)	6.425" (163.2mm)	6.551" (166.4mm)	6.929" (176.0±0.3mm)	5.468" (138.89mm)	3.465" (88.0mm)

TYPICAL 15.6" DIMENSIONS

4-Wire with Horizontal Tail & Wide Frame

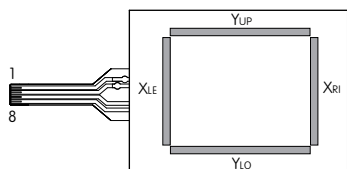
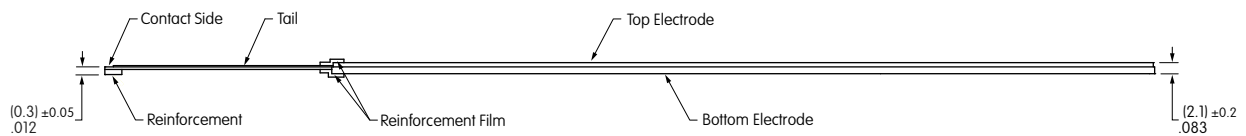
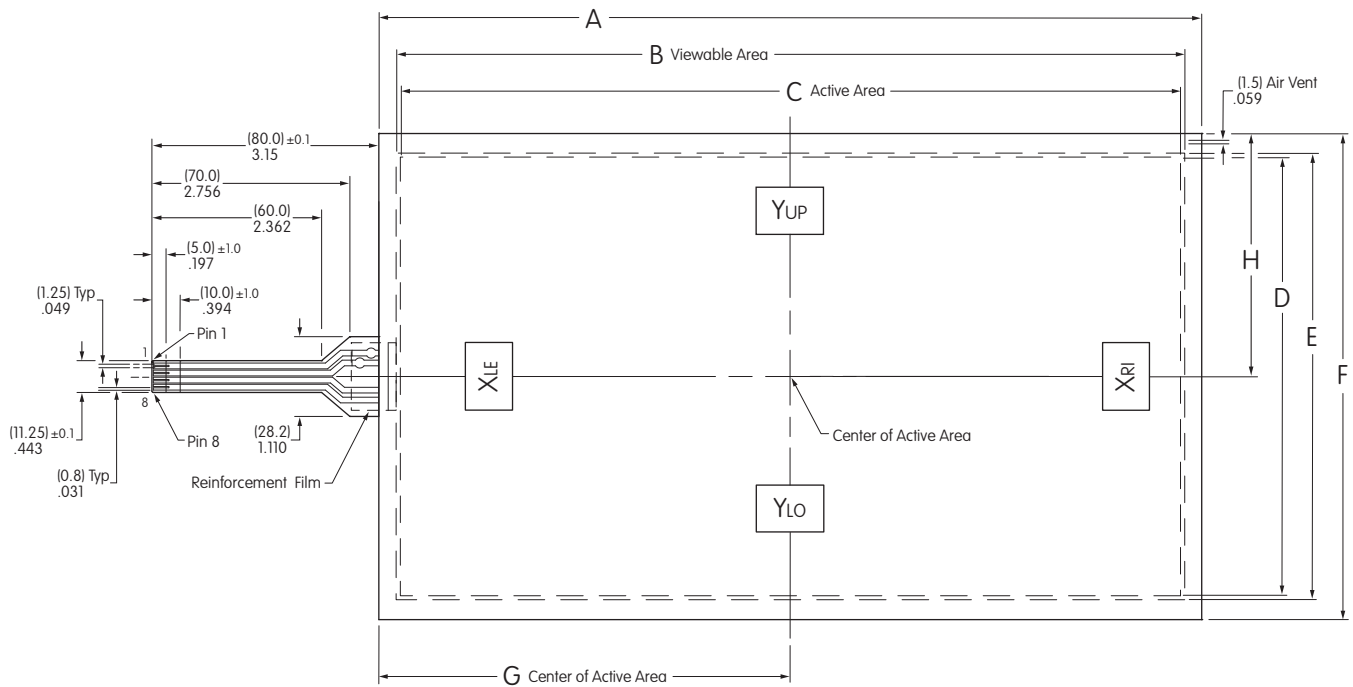

Y_{UP}, Y_{LO}: Top Electrode Terminal
X_{LE}, X_{RI}: Bottom Electrode Terminal

Pins	Signal
1, 2	Y _{UP}
3, 4	Y _{LO}
5, 6	X _{LE}
7, 8	X _{RI}

Typical Dimensions

Part Number	Screen Size in Inches	Dim A	Dim B Viewable Area	Dim C Active Area	Dim D Active Area	Dim E Viewable Area	Dim F	Dim G Center of Active Area (Horizontal)	Dim H Center of Active Area (Vertical)
FTAS00-15.6AW-4	15.6	14.276" (362.6±0.3mm)	13.681" (347.5mm)	13.551" (344.2mm)	7.618" (193.5mm)	7.748" (196.8mm)	8.433" (214.2±0.3mm)	7.138" (181.3mm)	4.217" (107.1mm)

4-Wire Touch Screen Controller Boards & Drivers

DISTINCTIVE CHARACTERISTICS

- Compatible with Control Board USB/RS232C
- Equipped with EPROM for Saving Setting Data
- Device Drivers are Windows 7 and 8 Compatible

Controller Boards		
Type	Part No.	Communication Protocol
4-Wire	FTCS04A/FTCS04A2	RS232C
4-Wire	FTCS04B	RS232C
4-Wire	FTCU04B	USB

System Configuration for USB

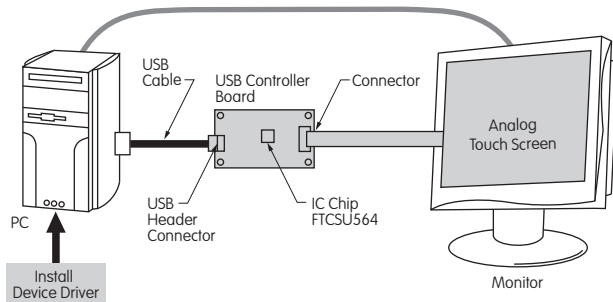

System Configuration for RS232C

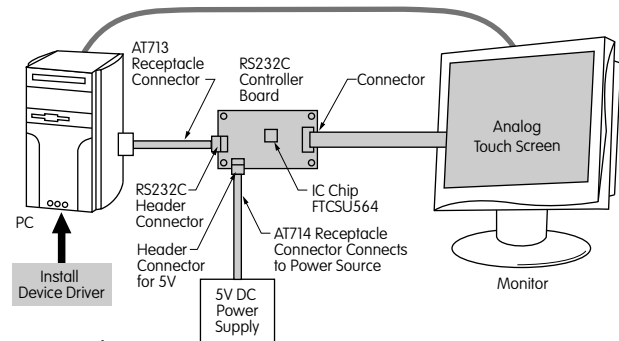

■ Available through NKK Switches

Touch panels can be operated the same as PC mouse functions by combining a control board or device driver and analog touch screen. For specifications or technical data for the controller boards and drivers, see NKK's web site or call our engineering support personnel.

General Specifications

Items	FTCS04A & FTCS04A2	FTCS04B	FTCU04B
Interface	RS232C	RS232C	USB 2.0 Full Speed
Clock	10MHz	6MHz	6MHz
Supply Voltage	5.0V	5.0V	5.0V
Resolution	10bit	10bit	10bit
Current Consumption	40mA maximum	40mA maximum	100mA maximum
Communication Speed	*1200, 2400, 4800, 9600, 19,200 bps (Standard is 9600 bps)	9600 bps	—
Communication Format	Data Length: 8bit Parity: None, Odd Number, Even Number Stop Bit: 1, 2	Data Length: 8bit Parity: None Stop Bit: 1	—

*Applies to FTCS04A only; may be changed by commanding from host on FTCS04A2

Absolute Maximum Ratings

Items	Symbols	Minimum	Maximum	Notes
Supply Voltage	V _{CC}	-0.3V	+5.5V (+6V)**	—
Input Voltage	V _{TP}	—	V _{CC} (V _{CC} +0.3)**	Touch Panel Input
	*V _{RS}	-15V(-25V)**	+15V (+25V)**	RS232C
Operating Temperature	T _{OPR}	0°C +32°F	+70°C +158°F	—
Storage Temperature	T _{STG}	-25°C -13°F	+85°C +185°F	—

Recommended Values

Items	Symbols	Minimum	Typical	Maximum	Notes
Supply Voltage	V _{CC}	+4.75V (+4.5V)**	+5	+5.25V (+5.5V)**	—
Operating Temperature	T _{OPR}	0	—	+70°C +158°F	No Condensation

()**Applies to FTCS04A & FTCS04A2

*V_{RS}: Applies Only to RS232C ()**Applies to FTCS04A & FTCS04A2

4-Wire Touch Screen Controller Boards & Drivers

DISTINCTIVE CHARACTERISTICS

- Device Driver function: Emulation software that enables operation of the touch screen same as a PC mouse
- Device Driver features two types of button modes; can be operated simultaneously with PS/2 mouse
- Device Driver Compatible with Windows 7 and 8 Operating Systems
- RS232C Controller Board consists of connector for 4-wire analog touch screen, RS232C header connector, 5V power supply header connector and helps simplify wiring. RS232C receptacle connector with wire assembly (AT713) and 5V power receptacle connector with wire assembly (AT714), are available as accessories.

AT713 Receptacle Connector



AT714 Receptacle Connector



Controller Board	Operating System	Availability
FTCS04B FTCU04B	Windows 7 and 8	Download from NKK Switches Website
FTCS04A	Windows 7 and 8	Download from NKK Switches Website
FTCS04A2	Device Driver Not Available	

NKK offers controller boards compatible with USB or RS232C. Refer to data sheets for FTCS04A, FTCS04B or FTCU04B. See website or contact NKK Switches for specifications and technical data.

Controller Boards Available for USB and RS232C

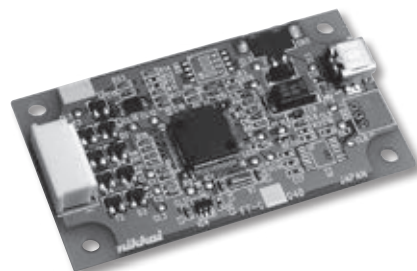

IC Chip for Analog Touch Screens

DISTINCTIVE CHARACTERISTICS

- Interface: USB and RS232C
- High Speed and Accuracy
- Built-in Calibration Function
- Data Function Removal Built In to Eliminate Noise

The IC is for use with the 4- and 5-wire transparent touch screens. When the screen is touched, it recognizes the position of the touch by the level of analog voltage detected by the A/D. The A/D converter receives the value and sends a set of coordinate values as serial data or USB.

Contact NKK Switches for the IC data sheet.

General Specifications for IC FTCSU548	
Package	LFQFP 48 Pins
Interface	Serial Interface (Asynchronous) or USB (Full Speed 2.0)
Supply Voltage	3.3/5.0V Typ; USB Available for 5V Only
* Rated Output Current	High Level: -170mA Low Level: +170mA
Operation Frequency	16MHz
A/D Converter Resolution	10bit
Operating Temperature	-20°C ~ +85°C (-4°F ~ +185°F)
Storage Temperature	-40°C ~ +125°C (-40°F ~ +257°F)

* Total Output Electric Current Amount of all the I/O Port

Controller Boards for RS232C

FTCS04A & FTCS04A2

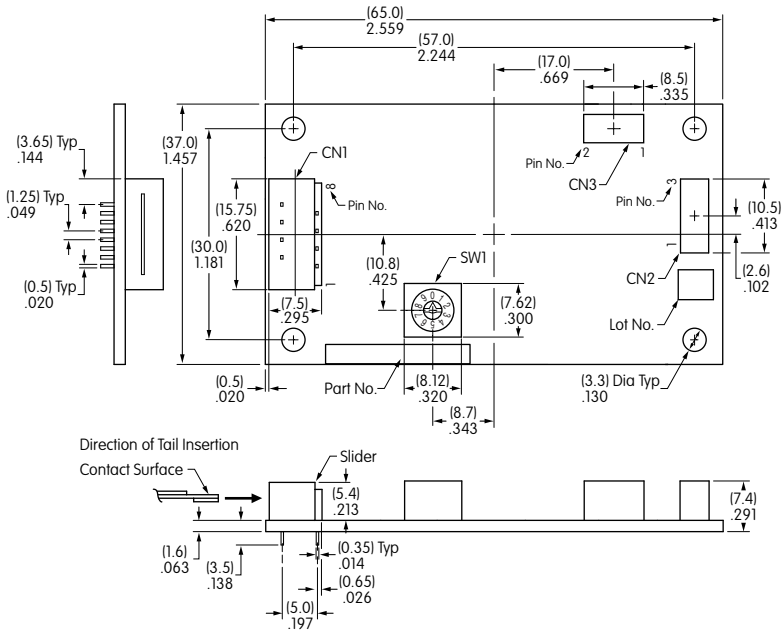

CN1 4-Wire Analog Touch Screen Connector - 8 Pins

Pin No.	Symbol	Description
1, 2	Y0	For Y _{UP} or Y _{LO}
3, 4	Y1	
5, 6	X0	For X _{RI} or X _{LE}
7, 8	X1	

CN2 RS232C Header Connector - 3 Pins

Pin No.	Symbol	Description
1	RD	Receiving Data
2	SD	Sending Data
3	GND	GND

CN3 Header Connector for Power Supply - 2 Pins

Pin No.	Symbol	Description
1	V _{CC}	Supply Voltage
2	GND	GND

FTCS04B for RS232C

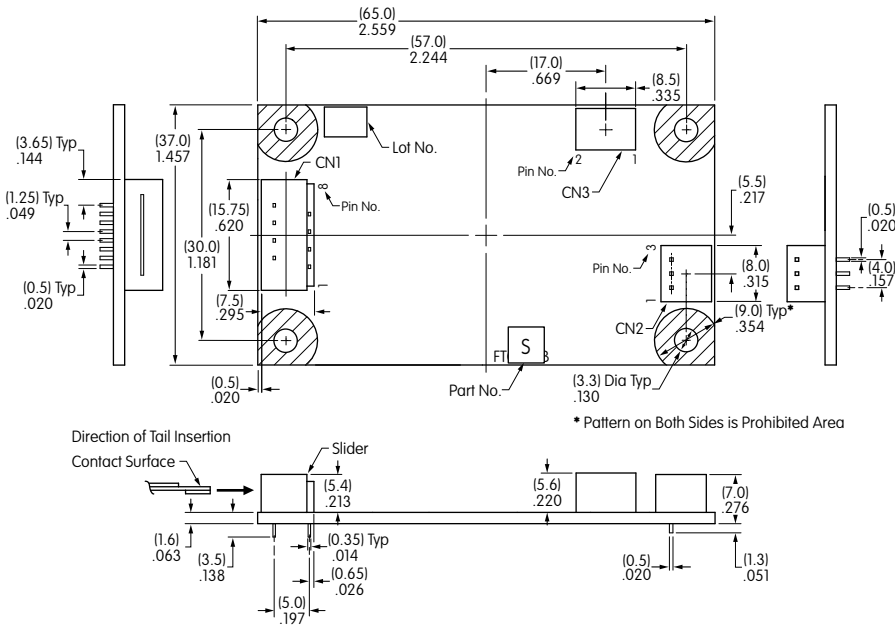

CN1 4-Wire Analog Touch Screen Connector - 8 Pins

Pin No.	Symbol	Description
1, 2	Y0	For Y _{UP} or Y _{LO}
3, 4	Y1	
5, 6	X0	For X _{RI} or X _{LE}
7, 8	X1	

CN2 RS232C Header Connector - 3 Pins

Controller Board Side			
Pin No.	Symbol	Description	Computer Side
1	RD	Receiving Data (IN)	Sending Data
2	SD	Sending Data (OUT)	Receiving Data
3	GND	GND	GND

CN3 Header Connector for Power Supply - 2 Pins

Pin No.	Symbol	Description
1	V _{CC}	Supply Voltage
2	GND	GND

OPTIONAL ACCESSORIES

Receptacle Connector & Wire Assembly for RS232C

AT713 is the Receptacle Connector with code to connect to RS232C communication of the controller boards. It is compatible with FTCS04A and FTCS04A2. The cable length is adjustable.

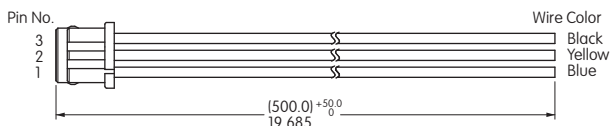

Receptacle Connector & Wire Assembly for Power Supply

AT714 is a Receptacle Connector with code to connect to FTCS04A or FTCS04A2 power source of the control boards. The cable length is adjustable.

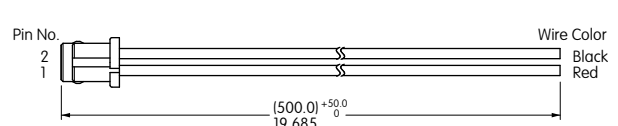

Controller Board for USB

FTCU04B for USB

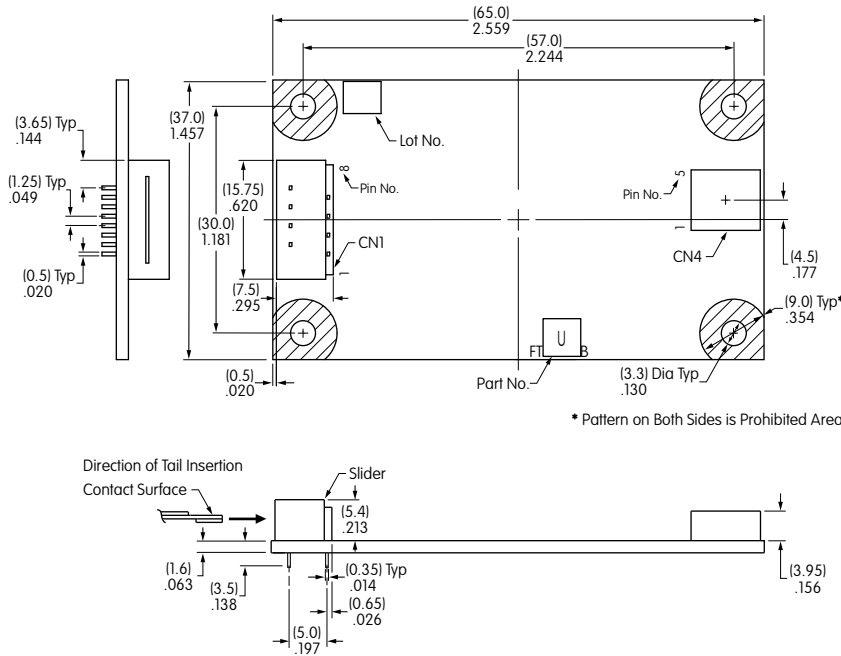

CN1 4-Wire Analog Touch Screen Connector - 8 Pins

Pin No.	Symbol	Description
1, 2	Y0	For Y _{UP} or Y _{LO}
3, 4	Y1	
5, 6	X0	For X _{RI} or X _{LE}
7, 8	X1	

CN4 Header Connector for USB - 5 Pins

Pin No.	Symbol	Description
1	V _{CC}	USB V _{CC}
2	D ₋	USB D ₋
3	D ₊	USB D ₊
4	GND	USB GND
5	GND	Shield GND

STORAGE, HANDLING & INSTALLATION

Handling of Controller Board

- Use arc prevention to protect device from static electricity.
- Power source should be activated after host and touch panel are connected.
- When inserting connector CN1 and touch panel tail, be sure the slider of connector CN1 is pulled. Do not pull more than 10 times.
- Do not alter the product.
- Do not use any commands other than the ones outlined in the specifications.
- Place the product away from noise source (such as inverter from LCD operation) since tail can be affected by noise.
- If device driver (USB) does not work after installation, reboot the host computer while connected to the controller board.
- This product does not support suspended mode (USB).
- Protocol of USB transmission is one frame per one transaction.
- Contact factory if not using the protocol above
- Warranty for one year after delivery. NKK warranties the 4-wire touch panel when it is used with the NKK control board and driver. Do not use third party control boards. NKK is not responsible for results of using damaged equipment with the controller boards.
- NKK Switches cannot assume responsibility for damages caused by software side during use of the touch screens.

Installation

- Products are ESD sensitive and ESD protection is required.
- Do not pull on the tail. Do not apply stress to the tail area.
- Avoid vibration or shock.
- The touch screen mounting should not be loose. This may cause an adverse effect on detecting performance during operation.
- Ensure there are no burrs around the edges of the case or housing that can cause false actuation. The edges of the case or housing should not enter the keying area.

STORAGE, HANDLING & INSTALLATION

Installation (Continued)

- The case or housing and upper electrode should have a space of about 0.5 mm to accommodate expansion or shrinkage due to temperature variances. If a shock barrier is used, do not press hard on the upper electrode area. Any shock barrier should be installed more than 0.6 mm away from A.

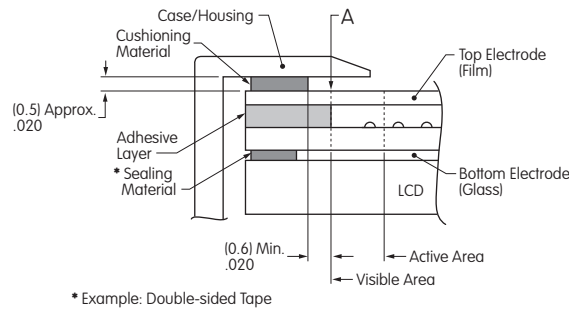

* Example: Double-sided Tape

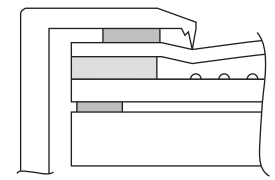

Example of Burr on Housing Interferes with Operation at Point A

- To secure the touch screen, secure the lower portion with a device such as the LCD display panel. Do not attach the upper electrode with double-sided tape or similar product to avoid stress that can damage the upper or lower electrode.
- In order to balance upper and lower pressure, an air vent may be installed. Ensure that no liquid or oil will enter into the device.
- Moisture from condensation on tail connection or edges may result in migration, causing short circuit failure.

Handling Precautions

- When opening product, take precaution with up/down and front/back directions. Glass edges are not chamfered, and corners or edges can be sharp. Wear gloves when handling the product.
- Do not pick up the product by the tail or pull the tail area.
- Use gloves or finger cots to prevent fingerprints on surface.
- When handling the product, hold it outside of the viewing area.
- Avoid stacking multiple products or placing other items on the product.
- Remove protective film after installation is completed.

Operating Precautions

- Operate with fingers or a touch screen stylus only.
- Do not press hard with a pen or similar object between viewing area and key area.

Design Precautions

- With analog type, resistive value change (by aging or individual differences) can dislocate the input area. Input area can be calibrated with software.
- When installing on top of an LCD, noise from the display device can create misoperation. To avoid noise, implement actions such as grounding the display device frame.
- Do not create software for simultaneous touch points, as analog type will read the center point between two touch points.
- When used to draw a line, analog type will have a break at dot spacer. Compensate for this with software.
- Contact resistance may cause chatter depending on pressing condition. Software should detect signal after it stabilizes.

Other Precautions

- Clean with a soft cloth and ethanol. Do not use any cleaning agents other than ethanol.
- Store product in original package and store at the temperature and humidity range specified.
- Do not store in an environment with acids or other corrosive gases or where condensation may occur.
- Not suited for use in critical control systems without proper fail-safe design consideration.
- Products are guaranteed based on evaluation of standards within the moisture tolerance and usage temperature range, but not guaranteed to operate perpetually at this temperature.
- Note that an incorrect type of connector may damage the print surface.
- Calibration data from one touch panel should not be applied to another panel; each should be calibrated individually.
- Recalibration is necessary if connector has been removed from the tail and reconnected.
- All specifications based on the tested touch screens only. Evaluate the products after installation with customer's equipment.

ANALOG TOUCH SCREENS

- The analog touch screen has a two-layer structure consisting of polyester film with an ITO membrane and sheet of glass. The surfaces of top and bottom electrodes have a uniform resistive film. One electrode draws in the X-axis direction, the other on the Y-axis direction. When pressure is applied, it changes the resistance value change between X1 and X2 and Y1 and Y2, then converts to a digital signal.

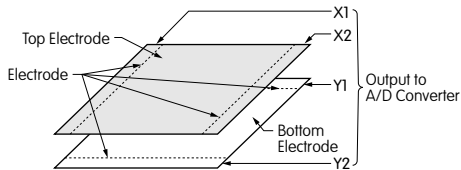

- To interpret the touched position, 5V is applied to the top electrode (X1 and X2). Then the voltage on the arrow direction evenly changes.

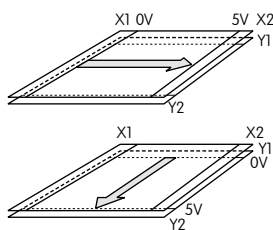

- With a touch to the center of the top electrode film, the touched position contacts the bottom film (glass), and 2.5V is output to Y1 (or Y2). The output signal is then converted to a digital signal and can be recognized as an X-axis coordinate value. In the same way, the Y-axis

coordinate value can be read from Y1 and Y2 on the bottom electrode. Then the position where the X and Y axis coordinate value intersected is read as the contact position.

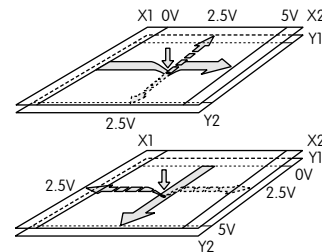

- The resolution of the analog touch screens is relatively higher than the digital models and contributes to the variety of the screen designs available, including those displaying buttons. Since analog types generally detect signals as a point but not as a number on the keys, the signals may be input as text or drawings with a pen. The vertical and horizontal resolution (detection points) is 1,024 when a 10bit A/D converter is used.

The active area of each button is independent of each other, resulting in no interference between the areas.

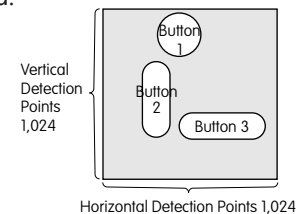

Standard Size ☉

New Standard Size ☉

Custom Size ○

Type	Sizes of Touch Screens in Inches																	
	3.5	5.7	6.2 Wide	6.5	7.0 Wide	8.4	8.5 Wide	10.4	10.5	10.6 Wide	12.1	12.1 Wide	14.0	15	15.6 Wide	17.0	17.1 18.1	19.0
Digital	○	☉	○	○	○	○	○	○	○		○		○	○		○	○	○
4-Wire Analog	○	☉	○	☉	○	☉	○	☉	○	☉	☉	☉	○	☉	☉	○	○	☉
5-Wire Analog								☉			☉			☉				
8-Wire Analog	○	○	○	○	○	○	○	○	○	○	○	○	○	○	○	○	○	○

NKK Switches feature a wide variety of standard touch screens. We also have the capability and expertise to offer custom solutions that would enhance any application. We can furnish designs in both digital (matrix) and analog type touch screens; custom sizes and key numbers; attachment of touch screen to LCDs or incorporation into peripheral devices; availability of film plus film combinations and fingerprint resistant, high transmittance films. Contact our experts and let us provide a resolution for all of your touch screen requirements.

Effective Date February 28, 2017



7850 East Gelding Drive • Scottsdale, AZ 85260 • Telephone 480.991.0942 • Fax 480.998.1435

<http://www.nkkswitches.com> • 1.877.2BUYNKK (228.9655)