



Lattice**CORE**

DDR3 PHY IP Core User Guide

IPUG96 Version 2.1, October 2016

Chapter 1. Introduction	5
Quick Facts	5
Features	6
Chapter 2. Functional Description	7
Overview	7
Initialization Module.....	8
Write Leveling	8
Read Training (Only for ECP5 Device)	8
Selecting READ_PULSE_TAP Value (Only for LatticeECP3 Device)	9
Data Path Logic.....	10
Write Data Path.....	10
Read Data Path.....	10
DDR3 I/O Logic.....	10
Signal Descriptions	10
Using the DFI	13
Initialization Control.....	13
Command and Address	14
Write Data Interface	15
Read Data Interface	15
Mode Register Programming	16
Chapter 3. Parameter Settings	18
Type Tab.....	20
Select Memory	20
RefClock (Only for ECP5 DDR3 IP)	20
Clock (for ECP3) MemClock (for ECP5)	20
Memory Type	21
Memory Data Bus Size	21
Configuration.....	21
DIMM0 Type or Chip Select Width.....	21
Address Mirror.....	21
Clock Width	21
CKE Width.....	21
2T Mode	21
Write Leveling	21
Controller Reset to Memory	21
Setting Tab.....	22
Row Size	22
Column Size.....	22
Burst Length.....	22
CAS Latency	22
Burst Type.....	22
Write Recovery.....	23
DLL Control for PD.....	23
ODI Control	23
RTT_Nom.....	23
Additive Latency.....	23
CAS Write Latency.....	23
RTT_WR	23
Pin Selection Tab.....	24
Manually Adjust.....	24
Pin Side.....	24
clk_in/PLL Locations	24
clk_in pin	24

PLL Used	25
DDR3 SDRAM Memory Clock Pin Location.....	25
DQS Locations	25
Design Tools Options and Info Tab.....	25
Support Synplify	26
Support Precision.....	26
Support ModelSim.....	26
Support ALDEC.....	26
Memory I/F Pins	26
User I/F Pins	27
Chapter 4. IP Core Generation and Evaluation for LatticeECP3 DDR3 PHY	28
Getting Started	28
IPexpress-Created Files and Top Level Directory Structure	30
DDR3 PHY IP File Structure	32
Hardware Evaluation.....	34
Enabling Hardware Evaluation in Diamond.....	34
Updating/Regenerating the IP Core	34
Chapter 5. IP Core Generation and Evaluation for ECP5 DDR3 PHY.....	36
Getting Started	36
Created Files and Top Level Directory Structure	39
DDR3 PHY IP File Structure	41
Simulation Files for IP Evaluation	43
Hardware Evaluation.....	45
Enabling Hardware Evaluation in Diamond.....	45
Regenerating/Recreating the IP Core	45
Regenerating an IP Core in Clarity Designer Tool.....	45
Recreating an IP Core in Clarity Designer Tool	46
Chapter 6. Application Support.....	47
Understanding Preferences	47
FREQUENCY Preferences	47
MAXDELAY NET	47
MULTICYCLE / BLOCK PATH.....	47
IOBUF	47
LOCATE.....	47
Handling DDR3 PHY IP Preferences in User Designs.....	47
Reset Handling.....	48
Dummy Logic in IP Core Evaluation	48
Top-level Wrapper File Only for Evaluation Implementation.....	48
Top-level Wrapper file for All Simulation Cases and Implementation in a User Design.....	49
RDIMM Module Support.....	49
Netlist Simulation	49
Chapter 7. Core Verification	50
Chapter 8. Support Resources	51
Lattice Technical Support.....	51
E-mail Support	51
Local Support	51
Internet	51
References.....	51
Revision History	51
Appendix A. Resource Utilization	52
ECP5 Devices	52
Ordering Part Number.....	52

LatticeECP3 FPGAs.....	53
Ordering Information	53
Appendix B. Lattice Devices Versus.....	54
Appendix C. DDR3 PHY IP Matrix.....	54
Appendix A. LatticeECP3 DDR3 PHY IP Locate Constraints.....	55

The Double Data Rate (DDR3) Physical Interface (PHY) IP core is a general purpose IP core that provides connectivity between a DDR3 Memory Controller (MC) and DDR3 memory devices compliant with JESD79-3 specification. This DDR3 PHY IP core provides the industry standard DDR PHY Interface (DFI) bus at the local side to interface with the memory controller. The DFI protocol defines the signals, signal relationships, and timing parameters required to transfer control information and data to and from the DDR3 devices over the DFI bus.

The DDR3 PHY IP core minimizes the effort required to integrate any available DDR3 memory controller with the Lattice FPGA's DDR3 primitives and thereby enables the user to implement only the logical portion of the memory controller in the user design. The DDR3 PHY IP core contains all the logic required for memory device initialization, write leveling, read data capture and read data de-skew that are dependent on Lattice FPGA DDR I/O primitives.

Quick Facts

Table 1-1 gives quick facts about the DDR3 SDRAM Controller IP core for ECP5™.

Table 1-1. DDR3 PHY IP Core Quick Facts for ECP5^{1, 2}

		DDR3 PHY IP Configuration								
		x8 2cs	x16 2cs	x24 2cs	x32 2cs	x40 2cs	x48 2cs	x56 2cs	x64 2cs	x72 2cs
Core Requirements	FPGA Families Supported	ECP5								
	Minimal Device Needed ¹	LFE5UM-85F-8MG285C	LFE5UM-85F-8MG285C	LFE5UM-85F-8MG381C	LFE5UM-85F-8MG381C	LFE5UM-85F-8BG554C	LFE5UM-85F-8BG756C	LFE5UM-85F-8BG756C	LFE5UM-85F-8BG756C	LFE5UM-85F-8BG756C
Resource Utilization	Targeted Device	LFE5UM-85F-8BG756C								
	Data Path Width	8	16	24	32	40	48	56	64	72
	LUTs	940	1070	1040	1140	1260	1360	1380	1440	1550
	sysMEM EBRs	0								
	Registers	740	970	1000	1180	1360	1510	1690	1850	2020
Design Tool Support	Lattice Implementation	Lattice Diamond® 3.3								
	Synthesis	Synopsys® Synplify Pro® for Lattice I-2014.03L-SP1								
	Simulation	Aldec® Active-HDL™ 9.3 Lattice Edition								
		Mentor Graphics® ModelSim® 6.6								

1. Device configuration x8 is considered. For x4 or x16 configurations, the minimal device may be different.

2. The LFE5U and LFE5UM devices have the same Resource Utilization values.

Table 1-2 gives quick facts about the DDR3 PHY IP core for LatticeECP3™.

Table 1-2. DDR3 PHY IP Core Quick Facts for LatticeECP3

		DDR3 PHY IP Configuration								
		x8 2cs	x16 2cs	x24 2cs	x32 2cs	x40 2cs	x48 2cs	x56 2cs	x64 2cs	x72 2cs
Core Requirements	FPGA Families Supported	LatticeECP3								
	Minimal Device Needed ¹	LFE3-17EA-6FN256C	LFE3-17EA-6FN256C	LFE3-17EA-6FN484C	LFE3-17EA-6FN484C	LFE3-17EA-6FN484C	LFE3-35EA-6FN484C	LFE3-35EA-6FN672C	LFE3-70EA-6FN672C	LFE3-70EA-6FN1156C
Resource Utilization	Targeted Device	LFE3-150EA-8FN1156C								
	Data Path Width	8	16	24	32	40	48	56	64	72
	LUTs	929	1060	1180	1320	1320	1430	1520	1620	1730
	sysMEM EBRs	0								
	Registers	820	1130	1430	1740	1560	1740	1920	2090	2300
Design Tool Support	Lattice Implementation	Lattice Diamond 3.3								
	Synthesis	Synopsys Synplify Pro for Lattice I-2014.03L-SP1								
	Simulation	Aldec Active-HDL 9.3 Lattice Edition								
		Mentor Graphics ModelSim 6.6								

1. Device configuration x8 is considered. For x4 or x16 configurations, the minimal device may be different.

Features

The DDR3 PHY IP core supports the following features:

- Interfaces to any DDR3 memory controller (MC) through the DDR PHY Interface (DFI) industry specification
- Interfaces to industry standard DDR3 SDRAM components and modules compliant with JESD79-3 specification
- Support for all ECP5 devices (LFE5U/LFE5UM) and all LatticeECP3 “EA” devices
- High-performance DDR3 operation up to 400 MHz/800 Mbps
- Supports memory data path widths of 8, 16, 24, 32, 40, 48, 56, 64 and 72 bits
- Supports x4, x8, and x16 device configurations
- Supports one unbuffered DDR3 DIMM or DDR3 RDIMM module with up to two ranks per DIMM
- Supports on-board memory (up to two chip selects)
- Programmable burst lengths of 8 (fixed), chopped 4 or 8 (on-the-fly), or chopped 4 (fixed)
- Supports automatic DDR3 SDRAM initialization with user mode register programming
- Supports write leveling for each DQS group. Option to switch off write leveling for on-board memory applications.
- Supports all valid DDR3 commands
- Supports dynamic On-Die Termination (ODT) controls
- I/O primitives manage read skews (read leveling equivalent)
- Option for controlling memory reset outside the IP core
- 1:1 frequency ratio interface between MC and DFI, 1:2 ratio between DFI and PHY

Functional Description

Overview

The DDR3 PHY IP core consists of the following sub-modules: initialization module, write leveling module, write data path, read data path, address/cmd control module and I/O logic module. This section briefly describes the operation of each of these modules. Figure 2-1 provides a high-level block diagram illustrating these main functional blocks and the technology used to implement the DDR3 PHY IP core functions.

Figure 2-1. DDR3 PHY IP Block Diagram

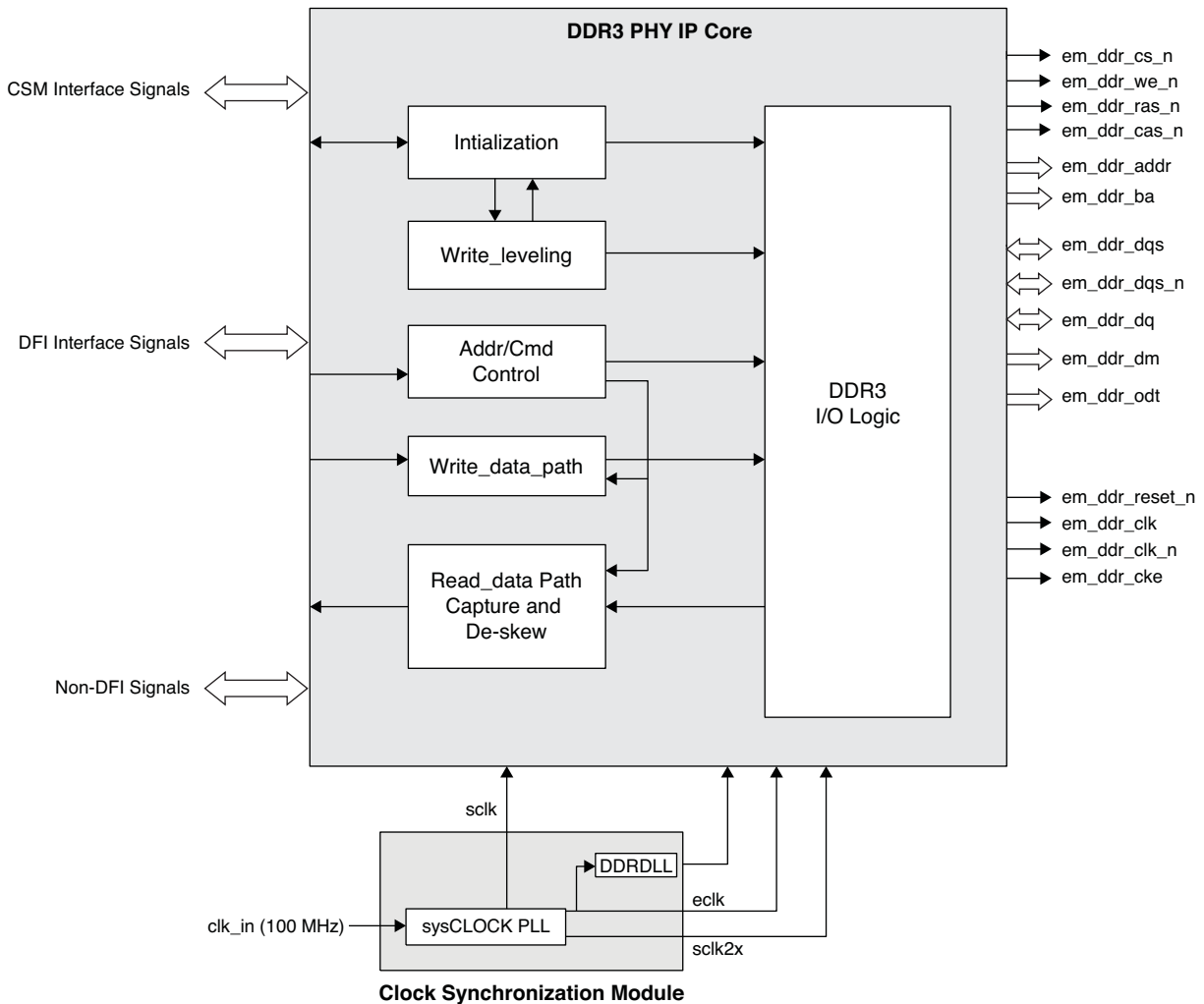

Along with the DDR3 PHY IP core, a separate module called the Clock Synchronization Module (CSM) is provided which generates all the clock signals, such as system clock (sclk), edge clock (eclk) and high-speed system clock (sclk2x) for the DDR3 PHY IP core. The CSM logic ensures that the domain crossing margin between eclk and sclk stays the same for the IDDR and ODDR buses that produce 2:1 gearing. Without proper synchronization, the bit order on different elements can become off sync and the entire data bus scrambled. Clock synchronization ensures that all DDR components start from exactly the same edge clock cycle.

The DDR3 PHY IP core works in a 1:1 frequency ratio between the MC and DFI. Inside the DDR3 PHY IP core, the initialization module, write leveling module, address/cmd control module, write data logic and read data capture

and de-skew logic operate using the `sclk`. These functional modules are implemented as soft logic in the FPGA fabric. This implies that the DFI of the DDR3 PHY IP core follows the 1:1 frequency ratio with the MC.

The DDR3 PHY IP core implements a 1:2 frequency ratio between the functional modules and the DDR I/O primitives. These I/O primitives are the hard logic of the FPGA and they use all the clocks (`sclk`, `eclk` and `sclk2x`) to implement a 1:2 gearing ratio between the functional block and the PHY memory interface. All transfers from the `sclk` to `eclk` domains and vice-versa happen within the DDR I/O primitives.

In a typical case, if the memory controller operates with a 200 MHz system clock (`sclk`), the functional modules of the DDR3 PHY IP core also operate with the same 200 MHz `sclk` while the DDR I/O logic of the IP core work primarily with the 400 MHz edge clock (`eclk`).

The combination of this operating clock ratio and the double data rate transfer leads to a user side data bus in the DFI that is four times the width of the memory side data bus. For example, a 32-bit memory side data width requires a 128-bit read data bus and a 128-bit write data bus at the user side interface.

Initialization Module

The Initialization Module performs the DDR3 memory initialization sequence as defined by JEDEC protocol. After power-on or after a normal reset of the DDR3 PHY IP core, memory must be initialized before sending any command to the IP core. It is the user's responsibility to assert the `dfi_init_start` input to the DDR3 PHY IP core to start the memory initialization sequence. The completion of initialization is indicated by the `dfi_init_complete` output provided by this block.

Since the DDR3 PHY IP core does not use the `dfi_data_byte_disable` or `dfi_freq_ratio` DFI signals, the input signal `dfi_init_start` needs to be asserted by the memory controller to trigger only a memory initialization process. It should be noted that this `dfi_init_start` signal is not used to change the frequency ratio.

Write Leveling

The write leveling block adjusts the DQS-to-CLK relationship for each memory device, using the write level mode of the DDR3 SDRAM when the fly-by wiring is implemented. Write leveling is always done immediately after a memory initialization sequence if write leveling is not disabled through the GUI. When the `dfi_init_complete` signal is asserted after the initialization process it also indicates the completion of write leveling. Along with the assertion of `dfi_init_complete`, the signal `wl_err` is also asserted if the write leveling process is not successful.

The main purpose of write leveling is to provide better signal integrity by using fly-by topology for the address, command, control and clock signals, and then by de-skewing the DQS signal delays to those signals at the DDR3 DRAM side. Since DDR3 memory modules have adapted fly-by topology, write leveling must be enabled for DIMM based applications. For on-board memory applications, the GUI provides the write leveling function as a user option. When enabled, the PCB for the on-board memory application must be routed using the fly-by topology. Otherwise, write leveling failures may occur due to the lack of guaranteed DQS to CLK edge relationship at the beginning of write level training. Due to this reason, the write leveling option must be disabled if the PCB does not utilize fly-by routing for write leveling.

The write leveling scheme of the DDR3 PHY IP core follows all the steps stipulated in the JEDEC specification. For more details on write leveling, refer to the JEDEC specification JESD79-3.

Read Training (Only for ECP5 Device)

For every read operation, the DDR3 I/O primitives of the ECP5 device must be initialized at the appropriate time to identify the incoming DQS preamble. Upon proper detection of the preamble, the primitive `DQSBUF1` extracts a clean `dqs` signal out of the incoming `dqs` signal from the memory and generates the `DATAVALID` output signal that indicates the correct timing window of the valid read data.

The DDR3 PHY IP generates an internal pulse signal, `READ[3:0]`, to the primitive `DQSBUF1` that is used for the above-mentioned operation. In addition to the `READ[3:0]` input, another input signal `READCLKSEL[2:0]` and an

output signal, BURSTDET, of the DQSBUFI block are provided to the PHY IP to accomplish the READ signal positioning.

Due to the DQS round trip delay that includes PCB routing and I/O pad delays, proper positioning of the READ signal with respect to the incoming preamble is crucial for successful read operations. The ECP5 DQSBUFI block supports a dynamic READ signal positioning function called read training that enables the PHY IP to position the READ signal within an appropriate timing window by progressively shifting the READ signal and monitoring the positioning result.

This read training is performed as part of the memory initialization process after the write leveling operation is complete. During the read training, the PHY IP generates the READ[3:0] pulse, positions this signal using READCLKSEL[2:0] and monitors the BURSTDET output of DQSBUFI for the result of the current position. The READ signal is set high before the read preamble starts. When the READ pulse is properly positioned, the preamble is detected correctly and the BURSTDET will go high. This will guarantee that the generated DATAVALID signal is indicating the correct read valid time window.

The READ signal is generated in the system clock (SCLK) domain and stays asserted for the total burst length of the read operation.

A minimum burst length of four on the memory bus is used in the read training process. The PHY IP can determine the proper position alignment when there is not a single failure on BURSTDET assertions during the multiple trials. If there is any failure, the PHY IP shifts the READ signal position and tries again until it detects no BURSTDET failure.

The PHY IP stores the delay value of the successful position of the READ signal for each DQS group. It uses these delay values during a normal read operation to correctly detect the preamble first, followed by the generation of DATAVALID signal.

Selecting READ_PULSE_TAP Value (Only for LatticeECP3 Device)

For every read operation, the DDR3 I/O primitives must be initialized at the appropriate time to identify the incoming DQS preamble in order to generate the data valid signal. For this purpose the PHY IP internally generates a signal called `dqs_read` in such a way that this signal's trailing edge is positioned within the incoming DQS preamble window.

Due to PCB routing delays, DIMM module routing delays and routing delays within the FPGA, the incoming DQS signal's delay varies from board to board. To compensate for this variability in DQS delay, the PHY IP shifts the internal signal `dqs_read` in such a way to position it within the preamble time.

Each shift (step) moves the `dqs_read` signal by one half period of the `eclk` (1.25 ns for 400 MHz memory clock).

A port, `read_pulse_tap`, is provided in the Core top level file `ddr3_sdram_mem_top_wrapper.v` for the user to load the shift count for each DQS group. Each DQS group is assigned a 3-bit shift count value in this port, starting with LSB 3 bits for `DQS_0`. This count can be any value from 0 to 7.

For the core to work properly on the board, it is recommended that the `dqs_read` signal be shifted by two steps for UDIMMs, by four steps for RDIMMs or by one step for on-board memory. Since the Eval simulation environment is provided without the PCB and FPGA internal routing delays, the recommended values for Eval simulation are: zero steps for UDIMMs, two steps for RDIMMs or zero steps for on-board memory.

A parameter `READ_PULSE_TAP` in `ddr_p_eval/testbench/tests/lecp3/tb_config_params.v` is made available to the user as an example. This parameter may be loaded to the port `read_pulse_tap` with appropriate values for simulation and synthesis.

In almost all cases the recommended value is good enough for stable read operations on the board and it is highly unlikely that the user has to change this value. If there are frequent read errors on the board, the user should try adjusting the shift count value loaded to the port `read_pulse_tap`.

Should there be a need to change the READ_PULSE_TAP value, it is suggested that the user starts with changing the value of DQS7 groups first and then move to adjacent group, if required.

Note: The DDR3 PHY IP may fail to generate or improperly generate the read_data_valid signal if the parameter READ_PULSE_TAP is not loaded to the read_pulse_tap input port or the values are not correct.

Data Path Logic

The Data Path Logic (DPL) block interfaces with the DDR3 I/O modules and is responsible for generating the read data and read data valid signals during read operations. This block implements all the logic needed to ensure that the data write/read to and from the memory is transferred to the local user interface in a deterministic and coherent manner.

Write Data Path

The write data path block interfaces with the DDR3 I/O modules and is responsible for loading the write data along with write data control signals to the DDR3 I/O primitives during write operations. This block implements all the logic needed to ensure that the data write to the memory is transferred from the DFI in a deterministic and coherent manner.

Read Data Path

The read data path block interfaces with the DDR3 I/O modules and is responsible for extracting the read data and read data valid signals during read operations. This block implements all the logic needed to ensure that the data read from the memory is transferred to the DFI in a deterministic and coherent manner. In addition, this block has the logic to deskew the read data delays between different data lanes.

DDR3 I/O Logic

The DDR3 I/O logic block provides the physical interface to the memory device. This block consists mainly of the LatticeECP3 or ECP5 device DDR3 I/O primitives supporting compliance to DDR3 electrical and timing requirements. These primitives implement all the interface signals required for memory access and convert the single data rate (SDR) DFI data to double data rate DDR3 data for the write operations. In read mode, they perform the DDR3-to-SDR conversion.

Signal Descriptions

Table 2-1 describes the user interface and memory interface signals at the top level.

Table 2-1. DDR3 PHY IP Core Top-Level I/O List

Port Name	Active State	I/O	Description
clk_in	N/A	Input	Reference clock to the PLL of the CSM block.
Clock Synchronization Module (CSM) Interface Signals			
sclk	N/A	Input	System clock used by the PHY IP core. This clock can be used for the DDR3 memory controller.
eclk	N/A	Input	Edge clock used by the DDR3 PHY IP core. Usually twice the frequency of sclk.
sclk2x	N/A	Input	High-speed system clock used by the IP core. Usually twice the frequency of sclk. (Only for LatticeECP3.)
wl_rst_datapath	High	Input	Signal from the IP core to the CSM module requesting a reset to the DDR primitive after a write leveling process is done. If multiple PHY IP cores are implemented in a design, use an AND gate to feed the wl_rst_datapath signals from all PHY IP cores and connect the output of the AND gate to the wl_rst_datapath input of the CSM module. (Only for LatticeECP3.)
dqsbufd_rst	High	Output	Signal from the CSM module to the IP core to reset the DDR primitive. (Only for LatticeECP3.)

Table 2-1. DDR3 PHY IP Core Top-Level I/O List (Continued)

Port Name	Active State	I/O	Description
clocking_good	High	Input	Signal from the CSM module indicating a stable clock condition.
dqsdel	High	Input	Master DQSDLL delay control line from CSM to the slave DLL delay in the IP core. (Only for LatticeECP3.)
uddcntln	Low	Output	DQSDLL update request from the IP core to the CSM logic. (Only for LatticeECP3.)
dll_update	High	Output	DQSDLL update request from the IP core to the CSM logic. (Only for ECP5.) Remains asserted till update_done is set high.
dqsbuf_pause	High	Input	Pause signal from CSM to the DDR3 I/O logic. (Only for ECP5.)
ddr_rst	High	Input	Reset signal from CSM to the DDR3 I/O logic. (Only for ECP5.)
ddrdel	High	Input	Master DQSDLL delay control line from CSM to the slave DLL delay in the IP core. (Only for ECP5.)
ddrdel_br	High	Input	Eclk bridge DQSDLL delay control line from CSM to the slave DLL delay in the IP core. (Only for ECP5.)
update_done	High	Input	Signal to indicate DQSDLL update is completed. (Only for ECP5.) dll_update is de-asserted once this signal is sampled as high.
Non-DFI Interface Signals			
mem_rst_n	Low	Input	Asynchronous reset signal from the user to reset only the memory device. This signal will not reset the DDR3 PHY IP core's functional modules. Refer to the Reset Handling section for more details.
read_pulse_tap [3*(DQS_WIDTH)-1:0]	N/A	Input	Read pulse tap – Counts the value from 0 to 7 by which the IP core's internal read pulse signal, dqs_read, is to be shifted for proper read_data_valid signal generation. Three bits are allocated for each DQS. Refer to the Netlist Simulation section for more details. (Only for LatticeECP3 DDR3 IP.)
phy_init_act	High	Output	Signal to indicate that the memory initialization process is active (in progress).
wl_act	High	Output	Signal to indicate that the memory write leveling process is active (in progress).
wl_err	High	Output	Write leveling error. Indicates failure in write leveling. The IP core will not work properly if there is a write leveling error. This signal should be checked when the init_done signal is asserted at the end of the initialization procedure.
rt_err	High	Output	Read Training error. Indicates failure in Read Training process. The PHY IP will not work properly if there is a Read Training error. This signal should be checked when init_done signal is asserted. (Only for ECP5 DDR3 IP.)
DFI Interface signals			
dfi_reset_n	Low	Input	Asynchronous reset. By default, when asserted, this signal resets the entire IP core and also the DDR3 memory. Refer to the Reset Handling section for more details.
dfi_address	N/A	Input	DFI address bus. This signal defines the address information that is intended for the DRAM memory devices for all control commands. The IP core preserves the bit ordering of the dfi_address signals when reflecting this data to the DRAM devices.
dfi_bank	N/A	Input	DFI bank bus. This signal defines the bank information that is intended for the DRAM devices for all control commands. The IP core preserves the bit ordering of the dfi_bank signals when reflecting this data to the DRAM devices.
dfi_cas_n	Low	Input	DFI column address strobe input. This signal defines the CAS information that is intended for the DRAM devices for all control commands.
dfi_cke[CKE_WIDTH-1:0]	High	Input	DFI clock enable input. This signal defines the CKE information that is intended for the DRAM devices for all control commands.

Table 2-1. DDR3 PHY IP Core Top-Level I/O List (Continued)

Port Name	Active State	I/O	Description
dfi_cs_n[CS_WIDTH-1:0]	Low	Input	DFI chip select input. This signal defines the chip select information that is intended for the DRAM devices for all control commands.
dfi_odt[CS_WIDTH-1:0]	High	Input	DFI on-die termination control input. This signal defines the ODT information that is intended for the DRAM devices for all control commands.
dfi_ras_n	Low	Input	DFI row address strobe bus. This signal defines the RAS information that is intended for the DRAM devices for all control commands.
dfi_we_n	Low	Input	DFI write enable input. This signal defines the WEN information that is intended for the DRAM devices for all control commands.
dfi_wrdata[DSIZE-1:0]	N/A	Input	Write data bus. Refer to the Write Data Interface section for more information.
dfi_wrdata_en	High	Input	Write data and data mask enable input. Refer to the Write Data Interface section for more information.
dfi_wrdata_mask[(DSIZE/8)[1:0]	High	Input	Write data byte mask input. Refer to the Write Data Interface section for more information.
dfi_rddata[DSIZE-1:0]	N/A	Output	Read data bus output. Refer to the Read Data Interface section for more information.
dfi_rddata_valid	High	Output	Read data valid indicator. Refer to the Read Data Interface section for more information.
dfi_init_complete	High	Output	This output signal is asserted for one clock period after the core completes memory initialization and write leveling. When sampled high, the input signal dfi_init_start must be immediately deasserted at the same edge of the sampling clock. Refer to the Initialization Control section for more details.
dfi_init_start	High	Input	Initialization start request input to the IP core. dfi_init_start should be asserted to initiate memory initialization either right after the power-on reset or before sending the first user command to the IP core. Since the DDR3 PHY IP core provides no support for dfi_data_byte_disable or dfi_freq_ratio, this input signal dfi_init_start is provided to the MC only to trigger a memory initialization process. Refer to the Initialization Control section for more details.
DDR3 SDRAM Memory Interface			
em_ddr_reset_n	Low	Output	Asynchronous reset signal from the controller to the memory device. Asserted by the controller for the duration of power on reset or active rst_n or active mem_rst_n. Refer to the Reset Handling section for more details.
em_ddr_clk[CLKO_WIDTH-1:0]	N/A	Output	Up to 400 MHz memory clock generated by the core. Lattice software automatically generates an additional complimentary port (em_ddr_clk_n) for each clock output port.
em_ddr_cke[CKE_WIDTH -1 :0]	High	Output	Memory clock enable generated by the core.
em_ddr_addr[ROW_WIDTH-1:0]	N/A	Output	Memory address bus – multiplexed row and column address information to the memory.
em_ddr_ba[2:0]	N/A	Output	Memory bank address.
em_ddr_data[DATA_WIDTH-1:0]	N/A	In/Out	Memory bi-directional data bus.
em_ddr_dm[(DATA_WIDTH/8)-1:0]	High	Output	DDR3 memory write data mask
em_ddr_dqs[DQS_WIDTH-1:0]	N/A	In/Out	Memory bi-directional data strobe. Lattice software automatically generates an additional complimentary port (em_ddr_dqs_n) for each dqs port.
em_ddr_dqs_n[DQS_WIDTH-1:0]	N/A	In/Out	Memory complimentary bi-directional data strobe
em_ddr_cs_n[CS_WIDTH_BB -1 :0]	Low	Output	Memory chip select.
em_ddr_cas_n	Low	Output	Memory column address strobe.

Table 2-1. DDR3 PHY IP Core Top-Level I/O List (Continued)

Port Name	Active State	I/O	Description
em_ddr_ras_n	Low	Output	Memory row address strobe.
em_ddr_we_n	Low	Output	Memory write enable.
em_ddr_odt[CS_WIDTH_BB -1 :0]	High	Output	Memory on-die termination control.

Using the DFI

The DFI specification includes a list of signals required to drive the memory address, command, and control signals to the DFI bus. These signals are intended to be passed to the DRAM devices in a manner that maintains the timing relationship of these signals on the DFI.

The DFI is subdivided into the following interface groups:

- Control Interface
- Write Data Interface
- Read Data Interface
- Update Interface (optional)
- Status Interface (optional)
- Training Interface (optional)
- Low Power Control Interface (optional)

The DDR3 PHY IP core provides support for the Control Interface, Write Data Interface and Read Data Interface. The other optional interfaces are not supported.

The Control Interface is a reflection of the DRAM control interface including address, bank, chip select, row strobe, column strobe, write enable, clock enable and ODT control, as applicable for the memory technology. The Write Data Interface and Read Data Interface are used to send valid write data as well as to receive valid read data across the DFI.

Initialization Control

DDR3 memory devices must be initialized before the memory controller accesses the devices. The DDR3 PHY IP core starts the memory initialization sequence when the `dfi_init_start` signal is asserted by the memory controller. Once asserted, the `dfi_init_start` signal needs to be held high until the initialization process is completed. The output signal `dfi_init_done` is asserted high by the core for only one clock cycle period indicating that the core has completed the initialization sequence and is now ready to access the memory. The `dfi_init_start` signal must be deasserted as soon as `dfi_init_done` is sampled high at the rising edge of `sclk`. If the `dfi_init_start` is left high at the next rising edge of `sclk`, the core sees this as another request for initialization and starts the initialization process again. Memory initialization is required only once, immediately after the system reset. As part of the initialization process the core performs write leveling for all the available DQS lanes and stores the write level delay values for each of those lanes. The core ensures a minimum gap of 500 μ s between `em_ddr_reset_n` deassertion and the subsequent `em_ddr_cke` assertion. It is the user's responsibility to ensure minimum reset duration of 200 μ s as required by the JEDEC specification.

Figure 2-2 shows the timing diagram of the initialization control signals.

Figure 2-2. Memory Initialization Control Timing

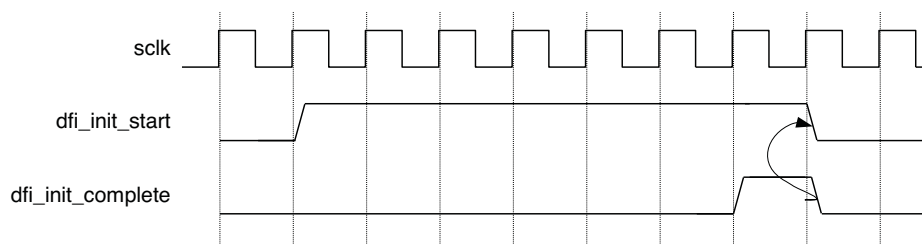

Command and Address

The DFI control signals `dfi_address`, `dfi_bank`, `dfi_cas_n`, `dfi_cke`, `dfi_cs_n`, `dfi_reset_n`, `dfi_odt`, `dfi_ras_n` and `dfi_we_n` correlate to the DRAM control signals.

These control signals are expected to be driven to the memory devices. The timing relationship of the control signals at the DFI bus are maintained at the PHY-DRAM boundary; meaning that all delays are consistent across all signals.

The DDR3 PHY IP core supports all the DDR3 memory commands. Refer to the DDR3 SDRAM Command Description and Operation table of the JESD79-3, DDR3 SDRAM Standard for more details about DDR3 memory commands.

Figure 2-3 shows the timing diagram for the Active command and Write/Read command when Additive Latency is selected as 0. The gap between the Active and Write/Read commands is derived from the t_{RCD} value of the memory device. Since the t_{RCD} value is expressed in terms of memory clocks, the corresponding System Clock count at the DFI bus is calculated as $(t_{RCD} + 1) / 2$. In this calculation, $(t_{RCD} + 1)$ is used to round off the memory clock to `sclk` conversion.

Figure 2-4 shows the timing diagram for the Active command and Write/Read command when Additive latency is selected as 1 or 2.

On the memory side, the gap between the Active command and the Write/Read command will be 0, 1 or 2 memory clocks more than the t_{RCD} value. This extra delay is due to the combined effect of the 1:2 gearing in the DDR3 PHY IP core and the write/read latency value, odd or even.

Figure 2-3. Active to Write/Read Command Timing for AL=0

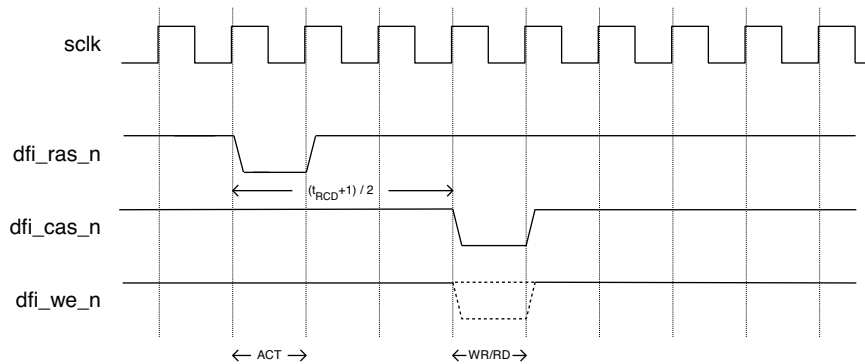
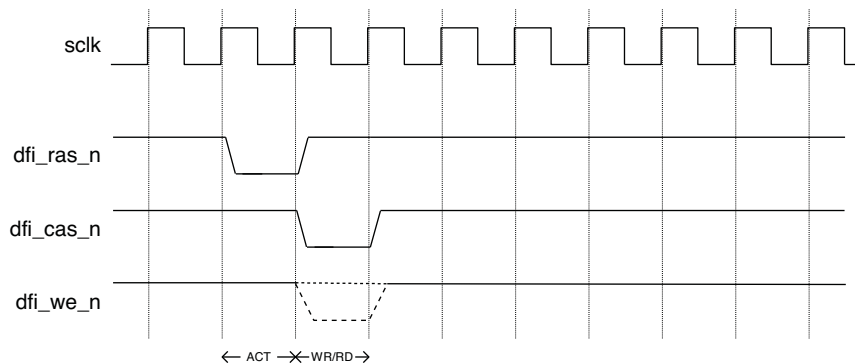

Figure 2-4. Active to Write/Read Command Timing for AL=1 and AL=2



Write Data Interface

The write transaction interface of the DFI includes the write data (dfi_wrdata), write data mask (dfi_wrdata_mask), and write data enable (dfi_wrdata_en) signals as well as the tphy_wrlat and tphy_wrdata delay timing parameters.

In the DDR3 PHY IP core, the parameter tphy_wrlat has a constant value which is the write latency in terms of the system clock (sclk). The tphy_wrlat is calculated using the equation, $tphy_wrlat = (wr_lat + 1) / 2$ where wr_lat is write latency in terms of memory clock. (wr_lat+1) is used to round off the memory clock to sclk conversion.

The parameter tphy_wrdata is always 0, therefore dfi_wrdata is valid from the time dfi_wrdata_en is asserted.

For a typical write operation, the memory controller asserts the dfi_wrdata_en signal tphy_wrlat cycles after the assertion of the corresponding write command on the DFI, and for the number of cycles required to complete the write data transfer sent on the DFI control interface. For contiguous write commands, the dfi_wrdata_en signal is to be asserted tphy_wrlat cycles after the first write command of the stream and is to remain asserted for the entire length of the data stream.

The associated write data (dfi_wrdata) and data masking (dfi_wrdata_mask) are sent along with the assertion of the dfi_wrdata_en signal on the DFI.

The write data timing on the DFI is shown in Figure 2-5. Refer to the evaluation simulation waveform for the DFI bus signal timing for different types of write operations (single, back-to-back, BC4 fixed, BL8 fixed and on-the-fly).

Figure 2-5. DFI Bus Write Timing

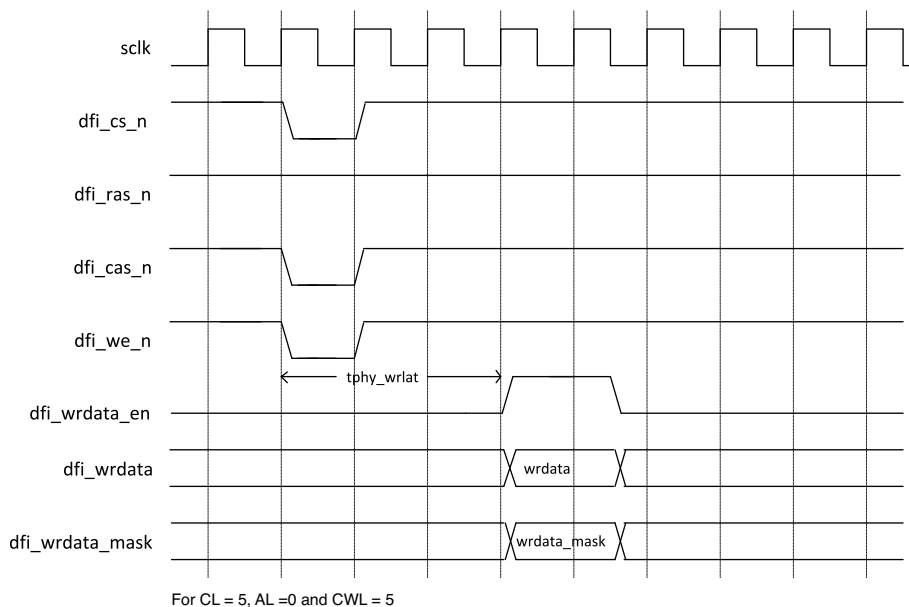

Read Data Interface

The read transaction portion of the DFI is defined by the read data enable (dfi_rddata_en), read data (dfi_rddata) bus and the valid (dfi_rddata_valid) signals as well as the trddata_en and tphy_rdlat timing parameters.

Since Lattice FPGAs support a preamble detect feature that automatically identifies read data valid timing, the signal dfi_rddata_en is not required for the DDR3 PHY IP core. The timing parameter trddata_en is also not required. The read command is accepted by the core when the dfi command input signal condition indicates a read command.

The DDR3 PHY IP core uses a total of nine sclks as core latency for the read command transmission, read data extraction and read data de-skewing. To calculate the tphy_rdlat value the memory device's read latency, in terms

of sclk, is added to this IP core's latency. For a memory read latency (RL) of six memory clocks, the corresponding tphy_rdlat is 12 scls which is $9 + ((RL+1)/2)$. In this calculation, (RL+1) is used to round off the memory clock to sclk conversion.

The read data will be returned, along with the signal dfi_rddata_valid asserted, after tphy_rdlat cycles from the time the read command is asserted.

The read data timing on the DFI is shown in Figure 2-6. Refer to the evaluation simulation waveform for the DFI bus signal timing for the different types of read operations (single, back-to-back, BC4 fixed, BL8 fixed and on-the-fly).

Figure 2-6. DFI Bus Read Timing

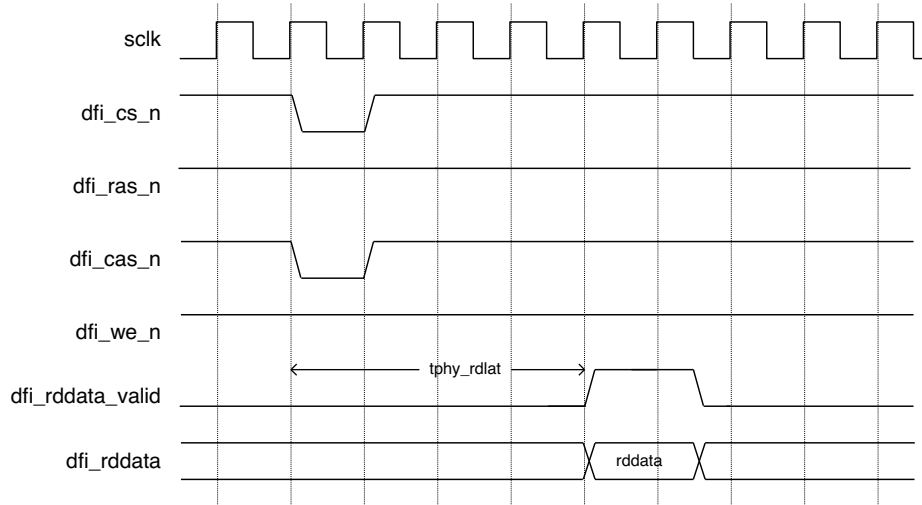

Mode Register Programming

The DDR3 SDRAM memory devices are programmed using the mode registers MR0, MR1, MR2 and MR3. The bank address bus (dfi_bank) is used to choose one of the mode registers, while the programming data is delivered through the address bus (dfi_address). The memory data bus cannot be used for the mode register programming.

The initialization process uses the mode register initial values selected in the PHY IP GUI. If these mode registers are not re-programmed by the user logic, using the LMR command, they will remain in the same configurations as programmed during the initialization process. Table 2-2 shows the list of available parameters and their initial default values from GUI if they are not changed by the user.

Table 2-2. Initialization Default Values for Mode Register Settings

Type	Register	Value	Description	Local Address	GUI Setting
MR0	Burst Length	2'b00	Fixed 8	addr[1:0]	Yes
	Burst Type	1'b0	Sequential	addr[3]	Yes
	CAS Latency	3'b000	CL = 5	addr[6:4], addr[2]	Yes
	Test Mode	1'b0	Normal	addr[7]	No
	DLL Reset	1'b1	DLL Reset = Yes	addr[8]	No
	WR Recovery	3'b010	6	addr[11:9]	Yes
	DLL Control for precharge PD	1'b1	Fast	addr[12]	Yes
	All Others	0		addr[ROW_WIDTH-1:13]	No

Table 2-2. Initialization Default Values for Mode Register Settings (Continued)

Type	Register	Value	Description	Local Address	GUI Setting
MR1	DLL Enable	1'b0	DLL Enable	addr[0]	No
	ODI Control	2'b00	RZQ/6	Addr[5],addr[1]	Yes
	RTT_nom	3'b001	RZQ/4	Addr[9],addr[6],addr[2]	Yes
	Additive Latency	2'b00	Disabled	addr[4:3]	Yes
	Write Level Enable	1'b0	Disabled	addr[7]	No
	TDQS Enable	1'b0	Disabled	addr[11]	No
	Qoff	1'b0	Enable	addr[12]	No
	All Others	0		addr[ROW_WIDTH-1:13]	No
MR2	CAS Write Latency	3'b000	5	addr[5:3]	Yes
	Rtt_WR	2'b01	RZQ/4	Addr[10:9]	Yes
	All Others	0			No
MR3	All	0		addr[ROW_WIDTH-1:0]	No

Parameter Settings

DDR3 PHY IP core Configuration GUI in IPexpress (for ECP3) or in Clarity Designer (for ECP5) tool is used to create IP and architectural modules in the Lattice Diamond software. Refer to [IP Core Generation and Evaluation for LatticeECP3 DDR3 PHY](#) or [IP Core Generation and Evaluation for ECP5 DDR3 PHY](#) for a description of how to generate the IP core.

Table 3-1 provides a list of user-configurable parameters for the DDR3 PHY IP core. The parameter settings are specified using the DDR3 PHY IP core Configuration GUI in IPexpress. The numerous DDR3 PHY IP parameter options are partitioned across multiple GUI tabs as shown in this chapter.

Table 3-1. IP Core Parameters

Parameter	Range/Options	Default
Type Tab		
Device Information		
Select Memory	Micron DDR3 1Gb-25E / Micron DDR3 2Gb-25E / Micron DDR3 4Gb-25E / Custom	Micron DDR3 1Gb-25E
Clock	400 / 333 / 300 MHz (for -8, -8L or -9 device) 333 / 300 MHz (for -7 or -7L device) 300 MHz (for -6 or -6L device)	400 (for -8, -8L or -9 device) 333 (for -7 or -7L device) 300 (for -6 or -6L device)
Memory Configuration		
Memory Type	Unbuffered DIMM / On-board Memory/ Registered DIMM	Unbuffered DIMM
Memory Data Bus Size	8 / 16 / 24 / 32 / 40 / 48 / 56 / 64 / 72	32
Configuration	x4/ x8/ x16	x8
DIMM Type (or Chip Select Width)	Single Rank / Double Rank (or 1 / 2)	Single Rank (or 1)
Address Mirror	Enable / Disable	Disabled
Clock Width	1 / 2 / 4	1
CKE Width	1 / 2	1
2T Mode	Unselected/Selected	Unselected
Write Leveling	Unselected/Selected	Selected
Controller Reset to Memory	Unselected/Selected	Selected
Setting Tab		
Address		
Row Size	12 - 16	14
Column Size	10 - 12	10
Mode Register Initial Setting		
Burst Length	Fixed 4, On the fly, Fixed 8	Fixed 8
CAS Latency	5,6,7,8	5
Burst Type	Sequential/Interleave	Sequential
Write Recovery	5,6,7,8,10,12	6
DLL Control for PD	Slow Exit/Fast Exit	Fast Exit
ODI Control	RZQ/6, RZQ/7	RZQ/6
RTT_Nom (ohm)	Disabled, RZQ/4, RZQ/2, RZQ/6, RZQ/12, RZQ/8	RZQ/4
Additive Latency	0, CL-1, CL-2	0
CAS Write Latency	5 / 6	5
RTT_WR	Off, RZQ/4, RZQ/2	RZQ/4

Table 3-1. IP Core Parameters (Continued)

Parameter	Range/Options	Default
Pin Selection Tab (Only for LatticeECP3)		
Manually Adjust	Unselected / Selected	Unselected
Pin Side		
Left side	Unselected / Selected	Selected
Right side	Unselected / Selected	Unselected
clk_in / PLL Locations¹		
clk_in pin	Refer Locate constraints ¹	U6 ¹
PLL used	Refer Locate constraints ¹	PLL_R61C5 ¹
DDR3 SDRAM Memory Clock Pin Location		
em_ddr_clk	(Bank 1 ² /Bank 2 /Bank 3) or (Bank 0 ² /Bank 6 /Bank 7)	Bank 6
DQS Locations		
DQS_0	Refer Locate constraints ¹	L10 ¹
DQS_1	Refer Locate constraints ¹	M10 ¹
DQS_2	Refer Locate constraints ¹	T9 ¹
DQS_3	Refer Locate constraints ¹	W6 ¹
DQS_4	Refer Locate constraints ¹	N/A ¹
DQS_5	Refer Locate constraints ¹	N/A ¹
DQS_6	Refer Locate constraints ¹	N/A ¹
DQS_7	Refer Locate constraints ¹	N/A ¹
DQS_8	Refer Locate constraints ¹	N/A ¹
Design Tools Option and Info Tab		
Design Tools Option		
Support Synplify	Unselected / Selected	Selected
Support ModelSim	Unselected / Selected	Selected
Support ALDEC	Unselected / Selected	Selected
Memory I/F Pins		
Number of BiDi Pins	Pin count for selected configuration	Pin count for selected configuration
Number of Output Pins	Pin count for selected configuration	Pin count for selected configuration
User I/F Pins		
Number of Input Pins	Pin count for selected configuration	Pin count for selected configuration
Number of Output Pins	Pin count for selected configuration	Pin count for selected configuration

1. The default values for the Pin Selection tab are target device-dependent. Default values provided in the table are for a LatticeECP3-150EA 1156-ball fpBGA device. Refer to Appendix C, [LatticeECP3 DDR3 PHY IP Locate Constraints](#) for further details.
2. The Bank 0 or Bank 1 option is available only for 333 MHz and 300 MHz speeds.

Type Tab

The Type tab allows the user to select a DDR3 PHY IP core configuration for the target memory device as well as the core functional features. These parameters are considered to be static parameters since the values for these parameters can only be set in the GUI. The DDR3 PHY IP core must be regenerated to change the value of any of these parameters. Figure 3-1 shows the contents of the Type tab.

Figure 3-1. DDR3 PHY IP Core Type Options

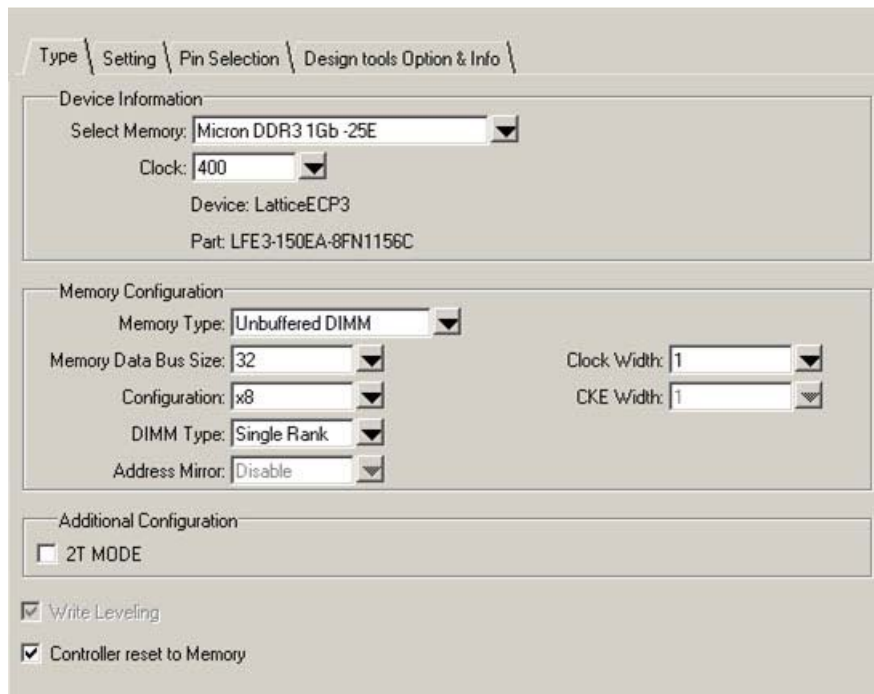

The Type tab supports the following parameters:

Select Memory

The Micron DDR3 1GB -25E is provided as the default DDR3 memory DIMM. The evaluation package comes with the memory model of this DIMM. The other option, Custom, provides a way to select timing and configuration settings for any other DIMM or on-board memory designs.

RefClock (Only for ECP5 DDR3 IP)

Refresh input clock to PLL which generates the system clock (SCLK) and memory clock (em_dds_clk).

*ECP3 DDR3 PHY IP can only work with a refresh input clock to PLL which is one fourth of the memory clock selected in the next field **Clock** in this **Type** tab.*

Clock (for ECP3) MemClock (for ECP5)

This parameter specifies the frequency of the memory clock to the DIMM or on-board memory. The allowed range is from 300 MHz to 400 MHz. The default value is linked to the speed grade of Lattice device selected. For example, the default memory clock for ECP5 -8 devices is 400 MHz. The corresponding value for ECP5 -7 devices is 333 MHz, and the corresponding value for ECP5 -6 devices it is 300 MHz.

In addition to the default value, the -8 device also has 2 more clock frequency options (333 MHz and 300 MHz) and the -7 device has one more frequency option (300 MHz).

Memory Type

This option is used to select the DDR3 memory type: Unbuffered DIMM module (UDIMM or SODIMM) or Registered DIMM module. Users can also choose “On-board Memory” for designs that implement on-board devices instead of DIMMs.

Memory Data Bus Size

This option allows the user to select the data bus width of the DDR3 memory to which the DDR3 PHY IP core is connected. If the memory module has a wider data bus than required, only the required data width has to be selected.

Configuration

This option is used to select the device configuration of the DIMM or on-board memory. The DDR3 PHY IP core supports device configurations x4, x8, and x16.

DIMM0 Type or Chip Select Width

When Unbuffered DIMM or Registered DIMM is selected as the Memory Type, this option allows the user to select the number (Single/Dual) of ranks available in the selected DIMM.

When On-board Memory is selected as the Memory Type, this option allows the user to select the number of chip selects required for the on-board memory.

Address Mirror

This option allows the user to select an address mirroring scheme for rank1 if a Dual DIMM module is used. This option is not available for on-board memory.

Clock Width

This field shows the number of clocks with which the DDR3 PHY IP core drives the memory. The IP core provides one differential clock per rank/chip select, as default. Users can select up to two differential clocks per rank/chip select.

CKE Width

This field shows the number of Clock Enable (CKE) signals with which the PHY IP drives the memory. The IP core provides one CKE signal per Rank/Chip select, as default.

2T Mode

This option allows the user to enable or disable the 2T timing for command signals when Unbuffered DIMM or Onboard Memory is selected. This option is not available for Registered DIMM modules.

Write Leveling

This option allows the user to enable or disable the write leveling operation of the DDR3 PHY IP core. This option to enable/disable write leveling is available only when the Memory Type is selected as On-board Memory. For unbuffered DIMM or registered DIMM, write leveling is always enabled.

Refer to [Initialization Module](#) section for more information.

Controller Reset to Memory

When this option is enabled, the asynchronous reset input signal, `rst_n`, to the DDR3 PHY IP core resets both the core and the memory devices. If this option is disabled (unchecked), the `rst_n` input of the core resets only the core, not the memory device. Refer to the [Reset Handling](#) section for more information.

Setting Tab

The Setting tab enables the user to select various configuration options for the target memory device/module. Parameters under the group, Mode Register Initial Setting, are dynamic parameters. Initialization values are set from the GUI. These values are dynamically changeable using LOAD_MR commands. Refer to the JESD79-3, DDR3 SDRAM Standard, for allowed the values.

Figure 3-2 shows the contents of the Setting tab.

Figure 3-2. DDR3 PHY IP Core Setting Options

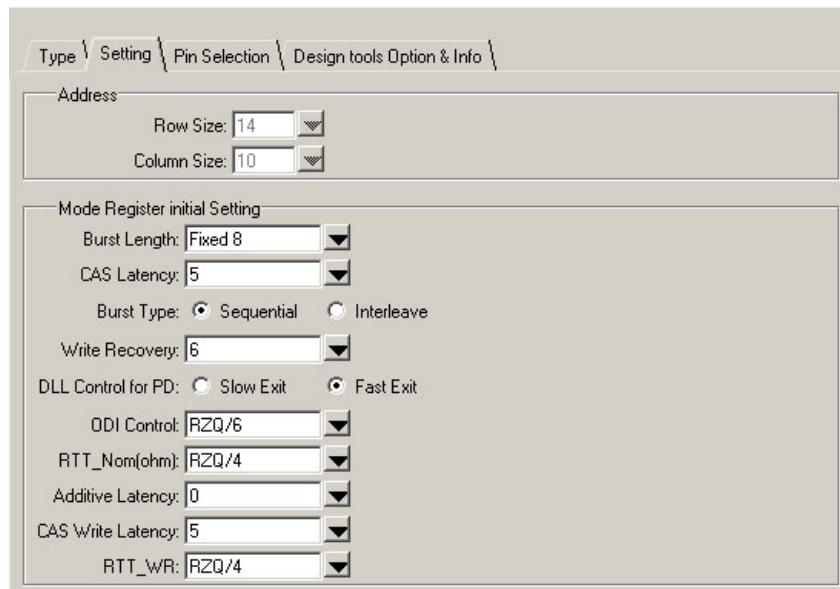

The Setting tab supports the following parameters:

Row Size

This option indicates the default row address size used in the selected memory configuration. If the option “Custom” is selected in the Select Memory field of the Type tab, the user can choose a value other than the default value.

Column Size

This option indicates the default column address size used in the selected memory configuration. If the option “Custom” is selected in the Select Memory field of the Type tab, the user can choose a value other than the default value.

Burst Length

This option sets the Burst Length value in Mode Register 0 during initialization. This value remains until the user writes a different value to Mode Register 0.

CAS Latency

This option sets the CAS Latency value in Mode Register 0 during initialization. This value remains until the user writes a different value to Mode Register 0.

Burst Type

This option sets the Burst Type value in Mode Register 0 during initialization. This value remains until the user writes a different value to Mode Register 0.

Write Recovery

This option sets the Write Recovery value in Mode Register 0 during initialization. It is set in terms of the memory clock. This value remains until the user writes a different value to Mode Register 0.

DLL Control for PD

This option sets the DLL Control for Precharge PD value in Mode Register 0 during initialization. This value remains until the user writes a different value to Mode Register 0.

ODI Control

This option sets the Output Driver Impedance Control value in Mode Register 1 during initialization. This value remains until the user writes a different value to Mode Register 1.

RTT_Nom

This option sets the nominal termination, Rtt_Nom, value in Mode Register 1 during initialization. This value remains until the user writes a different value to Mode Register 1.

Additive Latency

This option sets the Additive Latency, AL, value in Mode Register 1 during initialization. This value remains until the user writes a different value to Mode Register 1.

CAS Write Latency

This option sets the CAS Write Latency, CWL, value in Mode Register 2 during initialization. This value remains until the user writes a different value to Mode Register 2.

RTT_WR

This option sets the Dynamic ODT termination, Rtt_WR, value in Mode Register 2 during initialization. This value remains until the user writes a different value to Mode Register 2.

Pin Selection Tab

The Pin Selection tab enables users to assign device pin locations for reference input clock and DQS memory strobe signals. For each DQS location selected through this tab, the Lattice software automatically assigns pin locations for the associated DQ and DM signals. Figure 3-3 shows the contents of the Pin Selection tab. Refer to Appendix C: “DDR3 PHY IP Locate Constraints” for additional information.

Figure 3-3. DDR3 PHY IP Core Pin Selection Options (Only for LatticeECP3 Device)

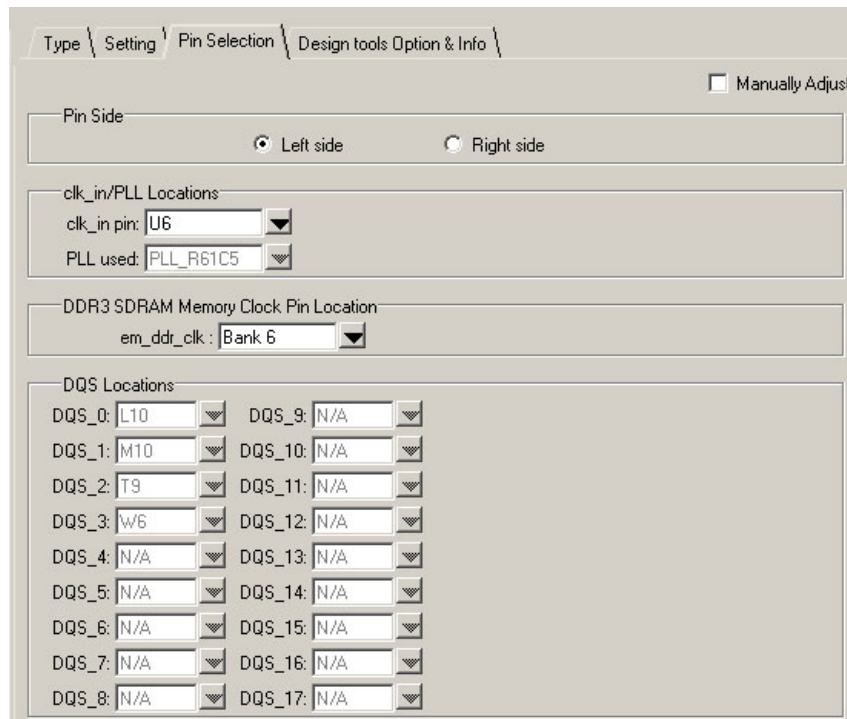

Manually Adjust

The pin locations displayed in this tab are the default pin locations when the user selects the device LFE3-150EA-8FN1156C in the IPexpress GUI.

Users can specify alternate pin locations specific to their application and hardware implementation by selecting the Manually Adjust checkbox.

Pin Side

In LatticeECP3-EA devices, only the left or right side I/O banks can be used for DDR3 Data (DQ), Data Strobe (DQS) and Data Mask (DM) signals. The top and bottom I/O banks cannot be used for these signals.

This parameter allows the user to select the device side (left or right) for locating these DDR3 signals.

clk_in/PLL Locations

This parameter supports two options: clk_in pin and PLL used.

clk_in pin

In LatticeECP3-EA devices, there is a dedicated clock input pad for each PLL. This option provides, through a pull-down menu, a list of legal clock input pins allowed for the DDR3 PHY IP core on the selected side. Refer to Appendix C: “DDR3 PHY IP Locate Constraints” for additional clock input pin options.

PLL Used

The content of this box specifies the location of the PLL that is connected to the selected clock input pin as specified by the `clk_in` pin option. This is a read-only field. To use a different PLL, the user must choose the appropriate clock input pin via the `clk_in` pin parameter.

DDR3 SDRAM Memory Clock Pin Location

`em_dds_clk`

This option, through a pull-down menu, shows the valid I/O banks available for locating the memory clock. For the 400 MHz memory clock operation, only the left or right side I/O banks are capable of working at that clock speed. For a 333 MHz or 300 MHz memory clock speed, the top side I/O banks can also be used. The pull-down menu lists the available I/O banks based on the memory clock speed selected in the Type tab.

Note that the memory clock signals use one full DQS group or a partial DDR group (a DDR group without DQS pin). When the memory clock signals are located either in the left or right side, the number of available DQS groups for locating the DQS/DQ signals in that side is reduced by one if one full DQS group is used for memory clock signal. The DDR3 PHY IP core GUI always checks whether the selected data width can be implemented using the available DQS groups. If it is not possible, the GUI prompts an error message when the IP core is being generated.

DQS Locations

This option allows the user to assign pins for each DQS signal of the selected configuration. All available pin locations for each DQS signal on the selected side are provided in a pull-down menu.

For each DQS pin, selected from the pull-down menu, the Lattice software will automatically assign pin locations for the associated DQ and DM signals.

Users should check for the duplicate assignment of more than one DQS signal to the same pin.

Note 1: Since there is no I/O bank restriction on address, command, and control signal pin selection, the user is expected to provide pin locations for these signals directly in the preference (.lpf) file.

Note 2: For designs with a memory clock speed of 400 MHz, the memory clock pads (`em_dds_clk` and `em_dds_clk_n`) should be located in the same side where the DQS pads are located. For designs with slower memory clock speeds (333 MHz and below), the memory clock pads can be placed either in the top I/O bank or in the same side where the DQS pads are located.

Design Tools Options and Info Tab

The Design Tools Options and Info tab enables the user to select the simulation and synthesis tools to be used for generating their design. This tab also provides information about the pinout resources used for the selected configuration. Figure 3-4 shows the contents of the Design Tools Options and Info tab.

Figure 3-4. DDR3 PHY IP Core Design Tools Options and Info Options in the IPexpress Tool

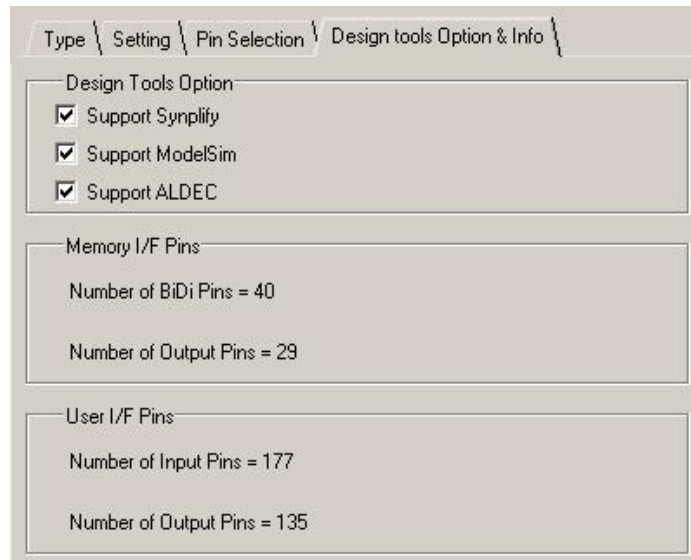

The Design Tools Options and Info tab supports the following parameters:

Support Synplify

If selected, IPexpress generates evaluation scripts and other associated files required to synthesize the top-level design using the Synplify synthesis tool.

Support Precision

If selected, IPexpress generates evaluation script and other associated files required to synthesize the top-level design using the Precision RTL synthesis tool.

Support ModelSim

If selected, IPexpress generates evaluation script and other associated files required to synthesize the top-level design using the ModelSim simulator.

Support ALDEC

If selected, IPexpress generates evaluation script and other associated files required to synthesize the top-level design using the Active-HDL simulator.

Memory I/F Pins

This section displays the following information:

Number of BiDi Pins

This is a notification on the number of bi-directional pins used in the memory side interface for the selected configuration. Bi-directional pins are used for the Data (DQ) and Data Strobe (DQS) signals only.

Number of Output Pins

This is a notification on the number of output-only pins used in the memory side interface for the selected configuration. Output-only pins are used for the DDR3 address, command, control, clock and reset signals.

User I/F Pins

This section displays the following information:

Number of Input Pins

This is a notification on the number of input-only pins used in the user side interface for the selected configuration. Input-only pins are used for user side write data, address, command and control signals. Write data width is four times that of the memory side data width.

Number of Output Pins

This is a notification on the number of output-only pins used in the user side interface for the selected configuration. Output-only pins are used for user side read data and status signals. Read data width is four times that of the memory side data width.



IP Core Generation and Evaluation for LatticeECP3 DDR3 PHY

This chapter provides information on how to generate the DDR3 PHY IP core using the Diamond software IPexpress tool, and how to include the core in a top-level design.

For flow guidelines and known issues on this IP core, see the Lattice DDR3 PHY IP readme.htm document. This file is available once the core is installed in Diamond. The document provides information on creating an evaluation version of the core for use in Diamond and simulation

Getting Started

The DDR3 PHY IP core is available for download from the Lattice IP server using the IPexpress tool. The IP files are installed, using the IPexpress tool, in any user-specified directory. After the IP core has been installed, it will be available in the IPexpress GUI dialog box shown in Figure 4-1.

The IPexpress tool GUI dialog box for the DDR3 PHY IP core is shown in Figure 4-1. To generate a specific IP core configuration, the user specifies:

- **Project Path** – Path to the directory where the generated IP files will be loaded.
- **File Name** – “username” designation given to the generated IP core and corresponding folders and files. *(Caution: ddr3 and ddr3_sdram_core are Lattice-reserved names. The user should not use any of these names as a file name.)*
- **Module Output** – Verilog or VHDL
- **Device Family** – Device family to which the IP core is to be targeted
- **Part Name** – Specific targeted device within the selected device family

Figure 4-1. IPexpress Dialog Box

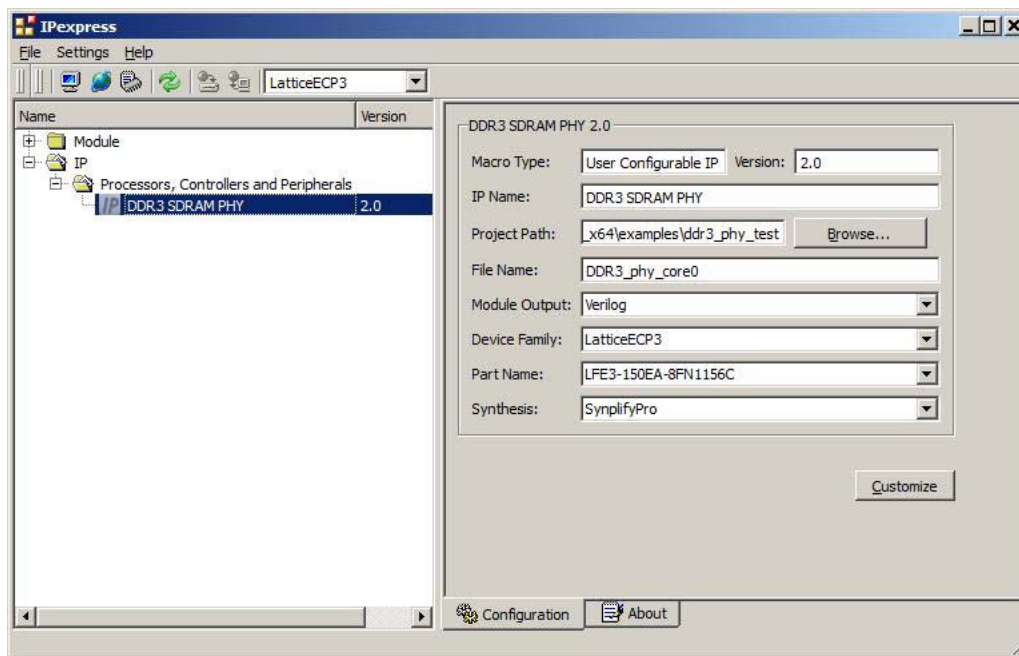

Note that if the IPexpress tool is called from within an existing project, Project Path, Design Entry, Device Family and Part Name default to the specified project parameters. Refer to the IPexpress online help for further information.

To create a custom configuration, the user clicks the **Customize** button in the IPexpress tool dialog box to display the DDR3 PHY IP core Configuration GUI, as shown in Figure 4-2. From this dialog box, the user can select the IP parameter options specific to their application. Refer to the [Parameter Settings](#) section for more information on the DDR3 PHY IP core parameter settings.

Figure 4-2. Configuration GUI

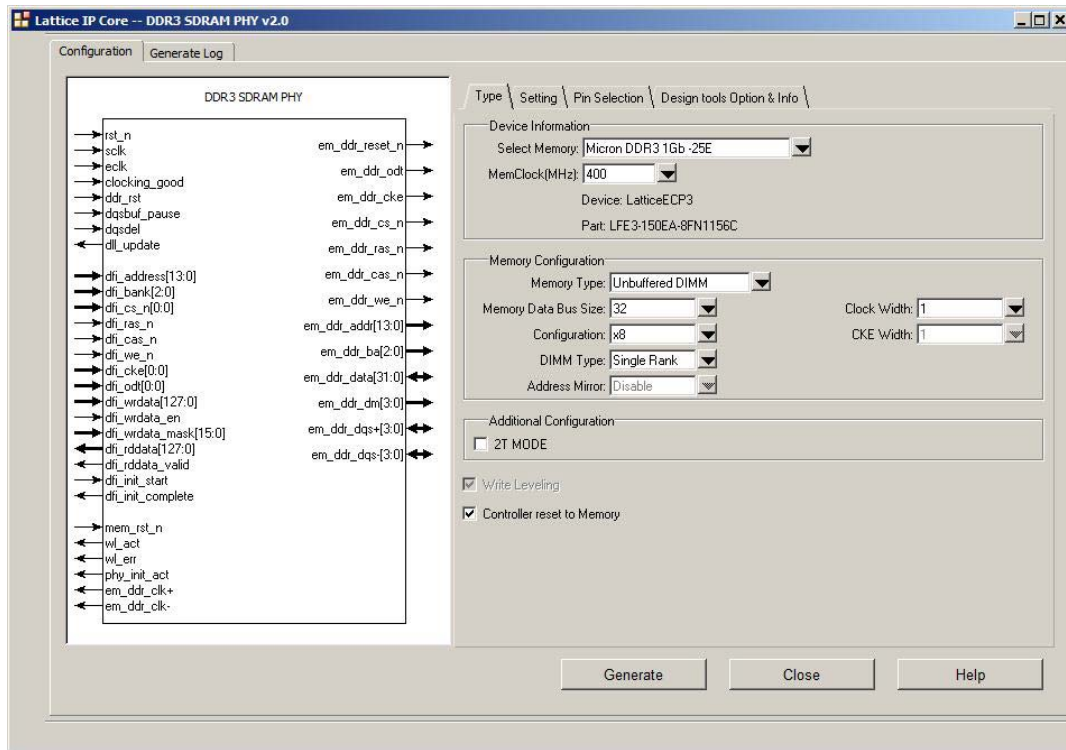

IPexpress-Created Files and Top Level Directory Structure

When the user clicks the **Generate** button in the IP Configuration dialog box, the IP core and supporting files are generated in the specified “Project Path” directory. The directory structure of the generated files is shown in Figure 4-3.

Figure 4-3. LatticeECP3 DDR3 Core Directory Structure

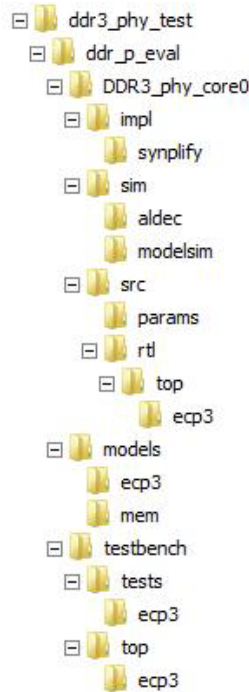

Understanding the core structure is an important step of a system design using the core. A summary of the files of the core for simulation and synthesis are listed in Table 4-1.

This table provides a list of key files and directories created by the IPexpress tool and how they are used. The IPexpress tool creates several files that are used throughout the design cycle. The names of most of the created files are customized to the user’s module name specified in IPexpress.

Table 4-1. File List

File	Simulation	Synthesis	Description
Source Files			
<username>.lpc			This file contains the IPexpress tool options used to recreate or modify the IP core in IPexpress.
<username>.ipx			The IPX file holds references to all of the elements of an IP core or module after it is generated from IPexpress (Diamond version only). The file is used to bring in the appropriate files during the design implementation and analysis. It is also used to re-load parameter settings into the IP/module generation GUI when an IP/module is being regenerated.
..\params\ddr3_sdr3_mem_params.v	Yes		This file provides user options of the IP core for the simulation models.
<username>_beh.v	Yes		This is the obfuscated core simulation model.

Table 4-1. File List (Continued)

File	Simulation	Synthesis	Description
..\src\rt\top\ecp3\ddr3_sdram_phy_top_wrapper.v ..\src\rtl\top\ecp3\ddr3_sdram_phy_top_wrapper.vhd	Yes	Yes	This is the top level file for simulation and synthesis for a user design (.v file if Verilog is selected or .vhd file if VHDL is selected). This file has black-box instantiations of the core and I/O modules and also source instantiation of clock synchronization module.
..\impl\ddr3_sdram_phy_top_wrapper.v ..\impl\ddr3_sdram_phy_top_wrapper.vhd		Yes	This is the top level file only for evaluation synthesis (.v file if Verilog is selected or .vhd file if VHDL is selected). This file has black-box instantiations of the core and I/O modules and also source instantiation of clock synchronization module.
<username>.ngo		Yes	This file provides the synthesized IP core for the selected configuration.
Model Files			
..\models\ecp3\ddr3_clks.v	Yes		These are source files of the Clock Synchronization Module (CSM). The CSM block provides the necessary clocks and required timings for DDR3 operations including the system clock (sclk) for the core and the edge clock (eclk) and the faster system clock (sclk2x) for I/O logic.
..\models\ecp3\ddr3_pll.v	Yes		
..\models\ecp3\jitter_filter.v	Yes		
..\models\ecp3\clk_stop.v	Yes		
..\models\ecp3\clk_phase.v	Yes		
..\models\ecp3\pll_control.v	Yes		
..\models\mem\ddr3.v	Yes		DIMM simulation model.
..\models\mem\ddr3_<DIMM_type>_<mem_data_width>.v	Yes		(DIMM_Type : dimm for UDIMM and on-board memory, rdimm for RDIMM)
..\models\mem\ddr3_parameters.vh	Yes		(mem_data_width: 8/16/24/32/40/48/56/64/72).
Evaluation Test Bench Files			
..\testbench\top\ecp3\test_phy_ctrl.v	Yes		This is the evaluation test bench file.
..\tests\ecp3\cmd_gen.v	Yes		This is the command generator for the evaluation test bench.
..\tests\ecp3\tb_config_params.v	Yes		This file contains the test bench configuration parameter.
..\tests\ecp3\testcase.v	Yes		This file is the evaluation test file.
Evaluation Simulation Script Files			
..\sim\aldec<core_name>_eval.do	Yes		This file contains the Active-HDL simulation script.
..\sim\aldec<core_name>_gatesim_<synthesis>.do	Yes		This file is the Active-HDL script for netlist simulation. This file is generated only if the selected device package has enough I/Os for all the user side and memory side signals. <synthesis>: Precision or Synplify
..\sim\modelsim<core_name>_eval.do	Yes		This file contains the ModelSim simulation script.
..\sim\modelsim<core_name>_gatesim_<synthesis>.do	Yes		This file is the ModelSim script for netlist simulation. This file is generated only if the selected device package has enough I/Os for all the user side and memory side signals. <synthesis>: Precision or Synplify

Table 4-1. File List (Continued)

File	Simulation	Synthesis	Description
Evaluation Implementation Script Files			
..\impl\synplify\ <username>_eval.ldf</username>		Yes	This is the Diamond project file for the Synplify flow.
..\impl\precision\ <username>_eval.ldf</username>		Yes	This is the Diamond project file for the Precision RTL flow.
..\impl\synplify\ <username>_eval.lpf</username>		Yes	This is the par preference file for the Synplify flow.
..\impl\precision\ <username>_eval.lpf</username>		Yes	This is the par preference file for the Precision RTL flow.
..\impl\synplify\post_route_trace.prf		Yes	This is the post_route preference file for the Synplify flow.
..\impl\precision\post_route_trace.prf		Yes	This is the post_route preference file for the Precision RTL flow.

DDR3 PHY IP File Structure

The DDR3 PHY IP core consists of the following blocks:

- Top-level wrapper (RTL)
- An obfuscated behavioral model of the DDR3 PHY IP core for simulation and an encrypted netlist for synthesis
- Clock Synchronous Module (RTL files for simulation and Verilog flow synthesis and a netlist file for VHDL flow synthesis)

All of these blocks are required to implement the IP core on the target FPGA. Figure 4-4 depicts the interconnection among the blocks.

Figure 4-4. File Structure of the DDR3 PHY IP Core

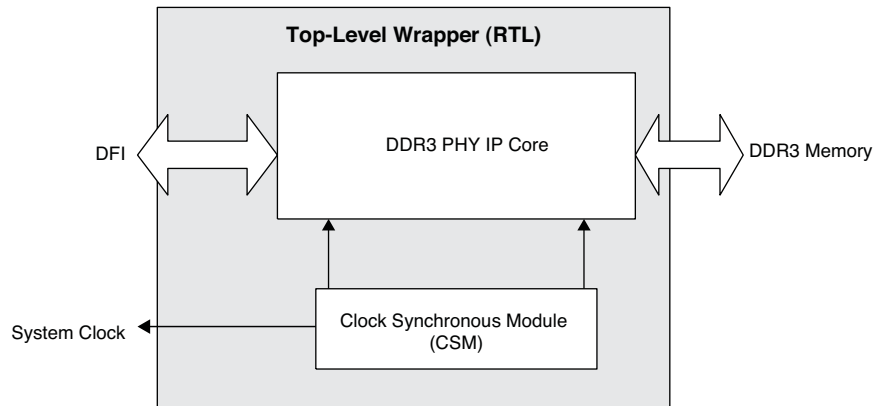

Top-level Wrapper

The IP core and the CSM block are instantiated in the top-level wrapper. When a system design is made with the DDR3 PHY IP core, this wrapper must be instantiated. If needed, the CSM block may be moved out of the wrapper and instantiated separately. The wrapper is fully configured as per the generated parameter file.

Clock Synchronization Module

The DDR3 PHY IP core uses a clock synchronization module that generates the system clock (sclk) for the core and the edge clock (eclk) and the high-speed system clock (sclk2x) for the I/O modules. This CSM module operates with a dedicated PLL which works on a reference clock input and generates the SCLK, ECLK and SCLK2x outputs. For easy regeneration of the PLL for different reference clock frequencies, the PLL module ddr3_pll.v is placed outside the CSM module in the directory ..\ddr_p_eval\models\ecp3. In addition to clock generation, this

CSM block performs a synchronization process, after every reset, to lock a pre-defined phase relationship between these clocks. This clock synchronization block uses a DQSDLL to extract a PVT-compensated 90 degree delay count to the I/O block that appropriately shifts the DQS signal during write and read operations.

The sclk clock output from the CSM block which drives the IP core is also made available to the external user logic. If a system that implements the DDR3 memory controller requires a clock generator external to the IP core, then the CSM block incorporated inside the IP core's top-level wrapper can be shifted out of the wrapper. Connections between the top-level wrapper and the clock generator are fully RTL based, and therefore, it is possible to modify the structure and connection of the core for the clock distribution to meet system needs.

This module is provided as RTL source for all cases of simulation and for Verilog flow synthesis. For VHDL flow synthesis, this module is available as a netlist.

Simulation Files for IP Core Evaluation

Once a DDR3 PHY IP core is generated, it contains a complete set of test bench files to simulate a few example core activities for evaluation. The simulation environment for the DDR3 PHY IP core is shown in Figure 4-5. This structure can be reused by system designers to accelerate their system validation.

Figure 4-5. Simulation Structure for DDR3 PHY IP Core Evaluation

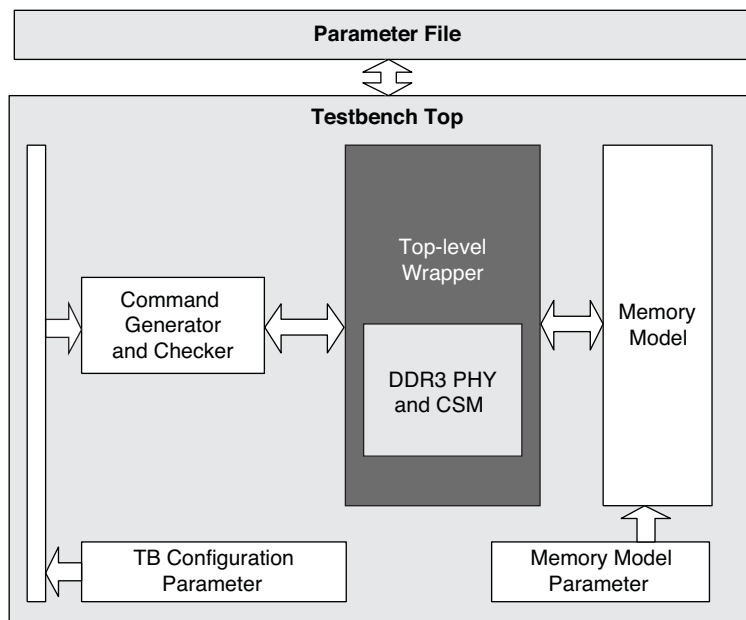

Test Bench Top

The test bench top includes the IP core under test, memory model, stimulus generator and monitor blocks. It is parameterized by the IP core parameter file.

Obfuscated PHY IP Simulation Model

The obfuscated top-level wrapper simulation model for the core includes all the PHY modules. This obfuscated simulation model must be included in the simulation.

Command Generator and Checker

The command generator generates stimuli for the IP core. The core initialization and command generation activities are predefined in the provided test case module. It is possible to customize the test case module to see the desired activities of the IP core.

Test Bench Configuration Parameter

The test bench configuration parameter provides the parameters for test bench files. These parameters are derived from the core parameter file and are not required to configure them separately. For those users who need a special memory configuration, however, modifying this parameter set might provide a support for the desired configuration.

Memory Model

The DDR3 PHY IP core test bench uses a memory simulation model provided by one of the most popular memory vendors. If a different memory model is required, it can be used by simply replacing the instantiation of the model from the memory configuration modules located in the same folder.

Memory Model Parameter

This memory parameter file comes with the memory simulation model. It contains the parameters that the memory simulation model needs. It is not necessary for users to change any of these parameters.

Evaluation Script File

ModelSim and Active-HDL simulation macro script files are included for instant evaluation of the IP core. All required files for simulation are included in the macro script. This simulation script can be used as a starting point of a user simulation project.

The evaluation test bench files are provided to show the DFI bus signal timing for typical memory access commands from the memory controller. These evaluation simulation files are made available only for the following memory settings: CL=5, AL=0, CWL=5. For any other memory setting values, the user is advised to refer to this user's guide and develop the corresponding simulation environment.

Note on Shortening Simulation Run Time

The DDR3 PHY IP core implements many timers to comply with JEDEC specifications. Due to these timers, the functional simulation takes a longer time at various stages of the simulation. In order to reduce the simulation run time, the IP core includes an option for lowering the timer counts, particularly on those timers used for waiting periods. This option can be enabled by adding a define SIM in the simulation script. It is important to note that this reduced timer value is valid for the simulation only and should not be included in the synthesis script.

Hardware Evaluation

The DDR3 PHY IP core supports Lattice's IP hardware evaluation capability, which makes it possible to create versions of the IP core that operate in hardware for a limited period of time (approximately four hours) without requiring the purchase of an IP license. It may also be used to evaluate the core in hardware in user-defined designs.

Enabling Hardware Evaluation in Diamond

Choose **Project > Active Strategy > Translate Design Settings**. The hardware evaluation capability may be enabled/disabled in the **Strategy** dialog box. It is enabled by default.

Updating/Regenerating the IP Core

By regenerating an IP core with the IPexpress tool, the user can regenerate a core with the same configuration or modify any of its settings including: device type, design entry method, and any of the options specific to the IP core. Regenerating can be done to modify an existing IP core or to create a new but similar one.

To regenerate an IP core in Diamond:

1. In IPexpress, click the **Regenerate** button.
2. In the Regenerate view of IPexpress, choose the IPX source file of the module or IP you wish to regenerate.
3. IPexpress shows the current settings for the module or IP core in the Source box. Make your new settings in the **Target** box.

4. If you want to generate a new set of files in a new location, set the new location in the **IPX Target File** box. The base of the file name will be the base of all the new file names. The IPX Target File must end with an .ipx extension.
5. Click **Regenerate**. The module's dialog box opens showing the current option settings.
6. In the dialog box, choose the desired options. To get information about the options, click **Help**. Also, check the **About** tab in IPexpress for links to technical notes and user guides. IP may come with additional information. As the options change, the schematic diagram of the module changes to show the I/O and the device resources the module will need.
7. To import the module into your project, if it's not already there, select **Import IPX to Diamond Project** (not available in stand-alone mode).
8. Click **Generate**.
9. Check the **Generate Log** tab to check for warnings and error messages.
10. Click **Close**.

The IPexpress package file (.ipx) supported by Diamond holds references to all of the elements of the generated IP core required to support simulation, synthesis and implementation. The IP core may be included in a user's design by importing the .ipx file to the associated Diamond project. To change the option settings of a module or IP core that is already in a design project, double-click the module's .ipx file in the File List view. This opens IPexpress and the module's dialog box showing the current option settings. Then go to step 6 above.



IP Core Generation and Evaluation for ECP5 DDR3 PHY

This chapter provides information on how to generate the DDR3 PHY core using the Lattice Diamond design software Clarity Designer tool, and how to include the core in a top-level design.

For example information and known issues on this core see the Lattice DDR3 PHY IP ReadMe document. This file is available once the core is installed in Diamond. The document provides information on creating an evaluation version of the core for use in Diamond and simulation

Getting Started

The DDR3 PHY IP core is available for download from the Lattice IP Server using the Clarity Designer tool. IP files are automatically installed using ispUPDATE technology in any customer-specified directory. After the IP core has been installed, invoke the Clarity Designer which opens the Clarity Designer tool dialog box shown in Figure 5-1.

- **Create new Clarity design** – Choose to create a new Clarity Design project directory in which the DDR3 SDRAM IP core will be generated.
- **Design Location** – Clarity Design project directory Path.
- **Design Name** – Clarity Design project name.
- **HDL Output** – Hardware Description Language Output Format (Verilog or VHDL).
- **Open Clarity design** – Open an existing Clarity Design project.
- **Design File** – Name of existing Clarity Design project file with .sbx extension.

Figure 5-1. Clarity Designer Tool Dialog Box

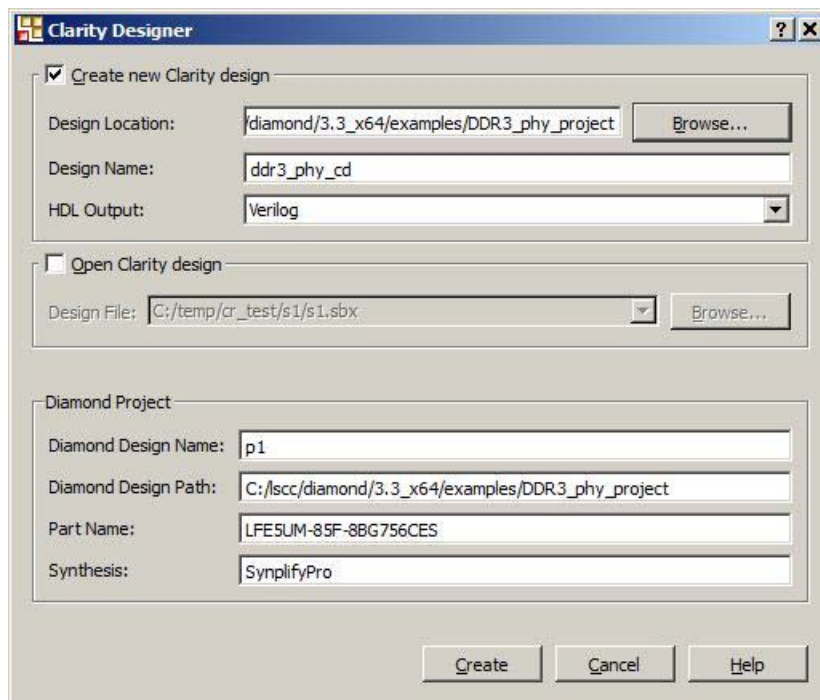

When the **Create** button is clicked, the Clarity Designer IP Catalog window opens as shown in Figure 5-2. You can generate DDR3 PHY IP configuration by double-clicking the IP name in the Catalog tab.

Figure 5-2. Clarity Designer IP Catalog Window

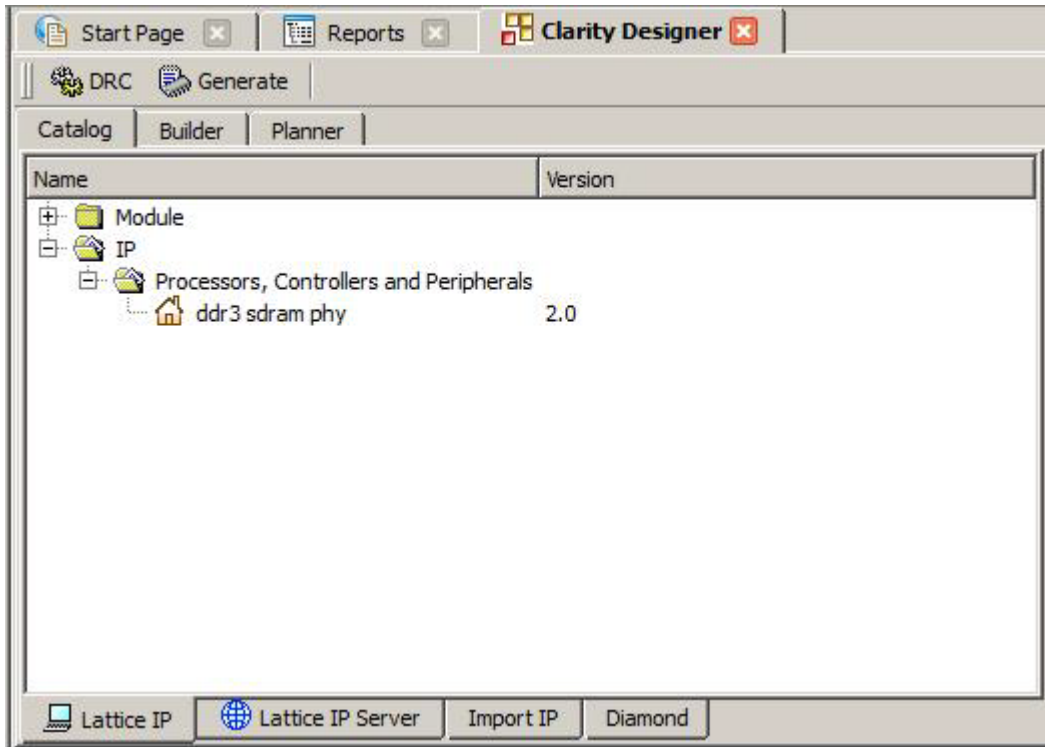

In the ddr3 sdram phy dialog box shown Figure 5-3, specify the following:

- **Instance Name** – The instance module name of the DDR3 PHY IP core. This Instance Name is also referred as username in this User Guide at different places.

Figure 5-3. IP Generation Dialog Box

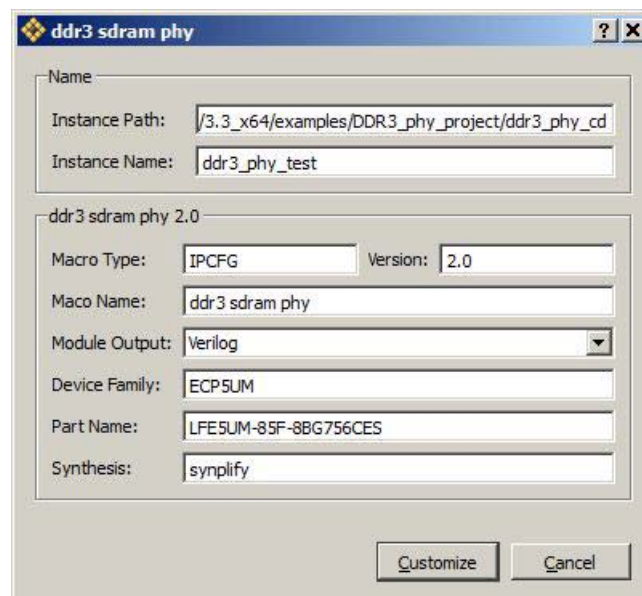

Note that if the Clarity Designer tool is called from within an existing project, Design Location, Device Family and Part Name default to the specified project parameters. Refer to the Clarity Designer tool online help for further information.

To create a custom configuration, click the **Customize** button in the IP Generation dialog box shown in Figure 5-3 to display the IP core Configuration GUI, as shown in Figure 5-4. From this dialog box, you can select the IP parameter options specific to their application. Refer to [Parameter Settings](#) for more information on the DDR3 PHY IP parameter settings.

Figure 5-4. IP Configuration GUI

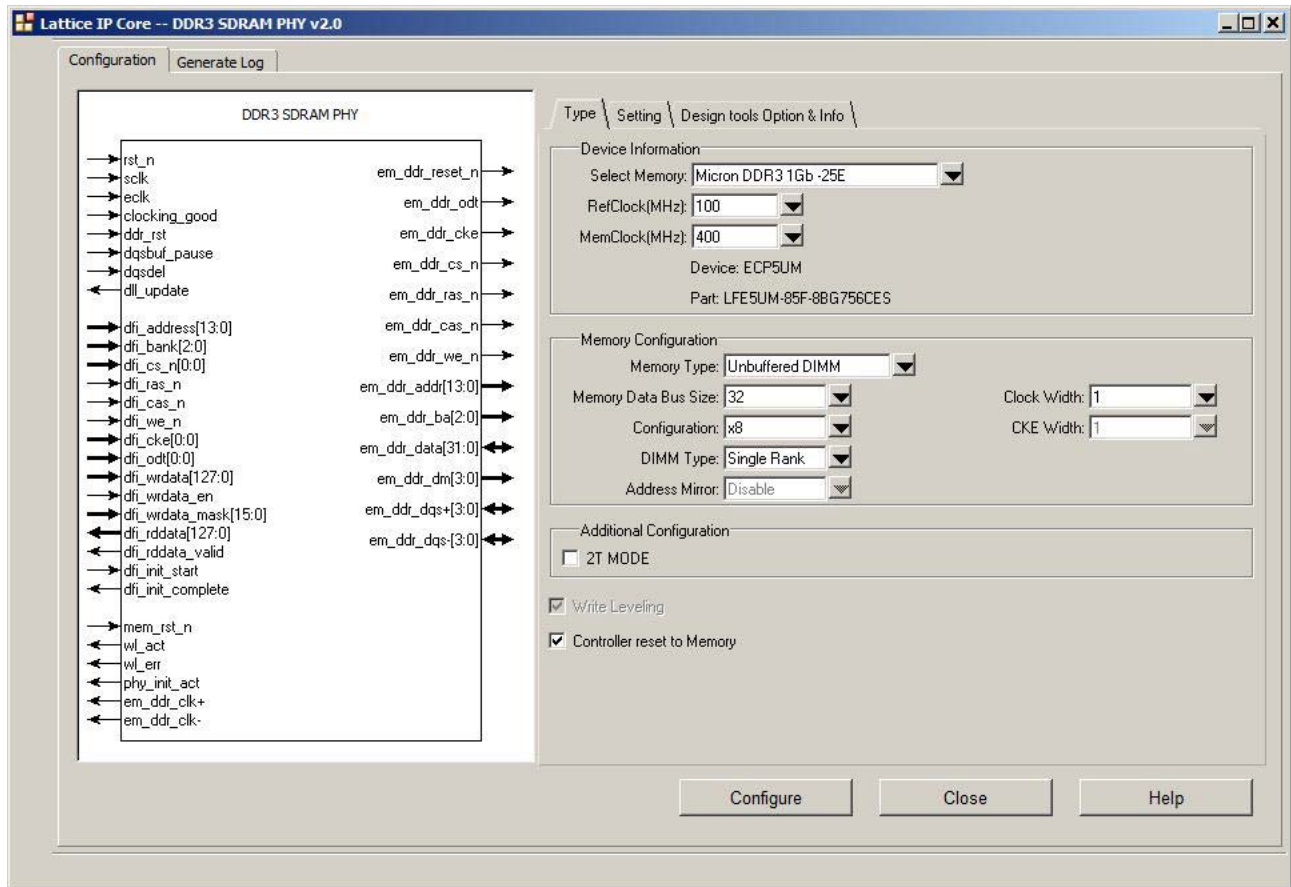

Created Files and Top Level Directory Structure

When the user clicks the **Generate** button in the IP Configuration dialog box, the IP core and supporting files are generated in the specified “Project Path” directory. An example of the directory structure of the generated files is shown in Figure 5-5.

Figure 5-5. ECP5 DDR3 Core Directory Structure

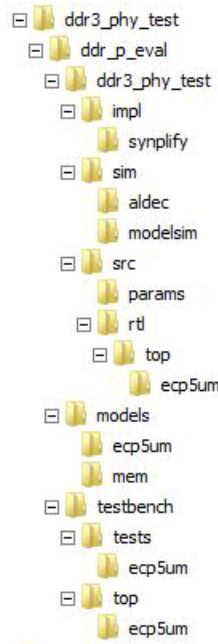

Understanding the core structure is an important step of a system design using the core. A summary of the files of the core for simulation and synthesis are listed in Table 5-1.

Table 5-1 provides a list of key files and directories created by the IPexpress tool and how they are used. The IPexpress tool creates several files that are used throughout the design cycle. The names of most of the created files are customized to the user’s module name specified in the IPexpress tool.

Table 5-1. File List

File	Simulation	Synthesis	Description
Source Files			
<username>.lpc			This file contains the Clarity Designer tool options to recreate the core.
..\params\ddr3_sdr3m_mem_params_<username>.v	Yes		This file includes all the selected and derived parameters of the generated IP.
<username>_beh.v	Yes		This is the obfuscated core simulation model.
..\rtl\top\<device>\ddr3_sdr3m_mem_top_wrapper_<username>.v ..\rtl\top\<device>\ddr3_sdr3m_mem_top_wrapper_<username>.vhd		Yes	This is the top Level file for simulation and synthesis (.v file if Verilog is selected or .vhd file if VHDL is selected). This file has black-box instantiations of the core and I/O modules and also source instantiation of clock synchronization module. Refer the section DUMMY LOGIC removal for more details.

Table 5-1. File List (Continued)

File	Simulation	Synthesis	Description
<username>.ngo		Yes	This file provides the synthesized IP core.
ddr_clks_<username>.ngo		Yes	This file provides the synthesized CSM module.
ddr3_sdram_phy_top_<username>.ngo		Yes	This file provides the synthesized IP Eval top level module.
pmi_pll_*.ngo		Yes	This file provides the synthesized PLL module.
Model Files			
..\models\<device>\ddr_clk_src.v	Yes		These are source files of Clock synchronization logic. PLL and DQSDLL are used to generate system clock (SCLK) for the core and edge clock (ECLK) for I/O logic.
..\models\<device>\pmi_pll_fp.v	Yes		
..\models\mem\ddr3_<username>.v	Yes		DIMM simulation model. (DIMM_Type : dimm for UDIMM, rdim for RDIMM), (mem_data_width: 8/16/24/32/40/48/56/64/72).
..\models\mem\ddr3_<DIMM_type>_<mem_data_width>_<username>.v	Yes		
..\models\mem\ddr3_parameters.vh	Yes		
Evaluation Test Bench Files			
..\testbench\top\<device>\test_phy_ctrl.v	Yes		This is the evaluation test bench top level file.
..\tests\<device>\cmd_gen_phy.v	Yes		This is the command generator for the evaluation test bench.
..\tests\<device>\tb_config_params.v	Yes		This file is the test bench configuration parameter.
..\tests\<device>\testcase.v	Yes		This file is the evaluation test bench.
Evaluation Simulation Script Files			
..\sim\aldec\<username>_eval.do	Yes		This file is the Aldec script.
..\sim\aldec\<username>_gatesim_<synthesis>.do	Yes		This file is the Aldec script for netlist simulation. This file is generated only if the selected device package has enough I/Os for all the user side and memory side signals. <synthesis> : precision or synplify
..\sim\modelsim\<username>_eval.do	Yes		This file is the ModelSim script.
..\sim\modelsim\<username>_gatesim_<synthesis>.do	Yes		This file is the ModelSim script for netlist simulation. This file is generated only if the selected device package has enough I/Os for all the user side and memory side signals. <synthesis> : precision or synplify
Evaluation Implementation Script Files			
..\impl\synplify\<username>_eval.ldf		Yes	This is the Diamond project file for Synplify flow
..\impl\lse\<username>_eval.ldf		Yes	This is the Diamond project file for LSE flow
..\impl\synplify\<username>_eval.lpf		Yes	This is the par preference file for Synplify flow
..\impl\lse\<username>_eval.lpf		Yes	This is the par preference file for LSE flow

Table 5-1. File List (Continued)

File	Simulation	Synthesis	Description
..\impl\synplify\post_route_trace.prf		Yes	This is the post_route preference file for Synplify flow
..\impl\lse\post_route_trace.prf		Yes	This is the post_route preference file for LSE flow

DDR3 PHY IP File Structure

The DDR3 PHY IP core consists of the following blocks:

- Top-level wrapper (RTL)
- An obfuscated behavioral model of the DDR3 PHY IP core for simulation and an encrypted netlist for synthesis
- Clock Synchronous Module (RTL files for simulation and Verilog flow synthesis and a netlist file for VHDL flow synthesis)

All of these blocks are required to implement the IP core on the target FPGA. Figure 5-6 depicts the interconnection among the blocks.

Figure 5-6. File Structure of the DDR3 PHY IP Core

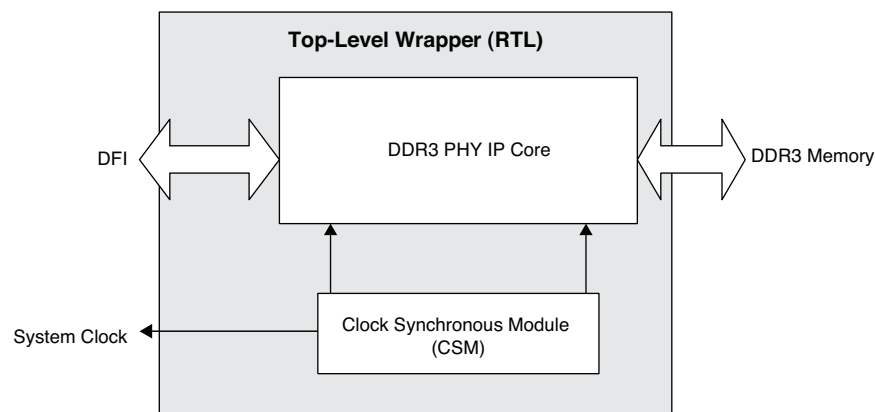

Top-level Wrapper

The IP core and the CSM block are instantiated in the top-level wrapper. When a system design is made with the DDR3 PHY IP core, this wrapper must be instantiated. If needed, the CSM block may be moved out of the wrapper and instantiated separately. The wrapper is fully configured as per the generated parameter file.

Clock Synchronization Module

The DDR3 PHY IP core uses a clock synchronization module that generates the system clock (sclk) for the core and the edge clock (eclk) and the high-speed system clock (sclk2x) for the I/O modules. This CSM module operates with a dedicated PLL which works on a reference clock input and generates the SCLK, ECLK and SCLK2x outputs. For easy regeneration of the PLL for different reference clock frequencies, the PLL module `ddr3_pll.v` is placed outside the CSM module in the directory `..\ddr_p_eval\models\ecp3`. In addition to clock generation, this CSM block performs a synchronization process, after every reset, to lock a pre-defined phase relationship between these clocks. This clock synchronization block uses a DQS DLL to extract a PVT-compensated 90 degree delay count to the I/O block that appropriately shifts the DQS signal during write and read operations.

The sclk clock output from the CSM block which drives the IP core is also made available to the external user logic. If a system that implements the DDR3 memory controller requires a clock generator external to the IP core, then the CSM block incorporated inside the IP core's top-level wrapper can be shifted out of the wrapper. Connections between the top-level wrapper and the clock generator are fully RTL based, and therefore, it is possible to modify the structure and connection of the core for the clock distribution to meet system needs.

This module is provided as RTL source for all cases of simulation and for Verilog flow synthesis. For VHDL flow synthesis, this module is available as a netlist.

Simulation Files for IP Core Evaluation

Once a DDR3 PHY IP core is generated, it contains a complete set of test bench files to simulate a few example core activities for evaluation. The simulation environment for the DDR3 PHY IP core is shown in Figure 5-7. This structure can be reused by system designers to accelerate their system validation.

Figure 5-7. Simulation Structure for DDR3 PHY IP Core Evaluation

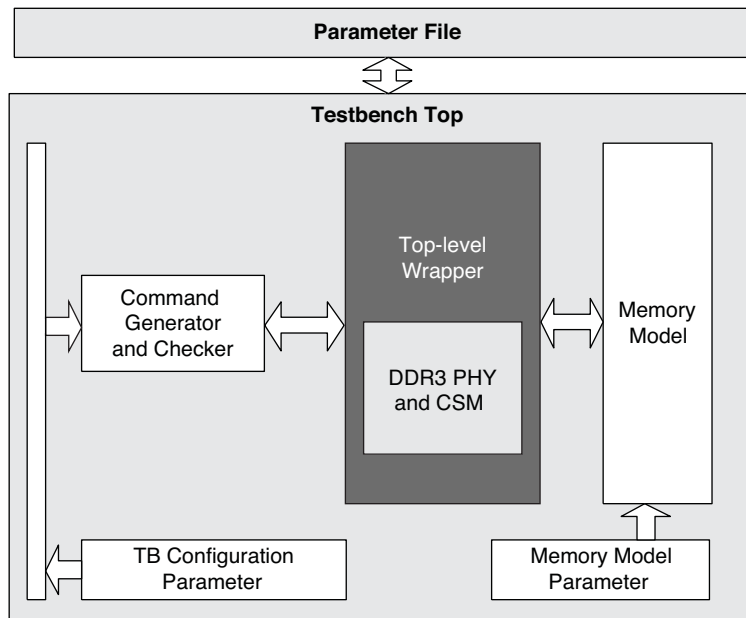

Test Bench Top

The test bench top includes the IP core under test, memory model, stimulus generator and monitor blocks. It is parameterized by the IP core parameter file.

Obfuscated PHY IP Simulation Model

The obfuscated top-level wrapper simulation model for the core includes all the PHY modules. This obfuscated simulation model must be included in the simulation.

Command Generator and Checker

The command generator generates stimuli for the IP core. The core initialization and command generation activities are predefined in the provided test case module. It is possible to customize the test case module to see the desired activities of the IP core.

Test Bench Configuration Parameter

The test bench configuration parameter provides the parameters for test bench files. These parameters are derived from the core parameter file and are not required to configure them separately. For those users who need a special memory configuration, however, modifying this parameter set might provide a support for the desired configuration.

Memory Model

The DDR3 PHY IP core test bench uses a memory simulation model provided by one of the most popular memory vendors. If a different memory model is required, it can be used by simply replacing the instantiation of the model from the memory configuration modules located in the same folder.

Memory Model Parameter

This memory parameter file comes with the memory simulation model. It contains the parameters that the memory simulation model needs. It is not necessary for users to change any of these parameters.

Evaluation Script File

ModelSim and Active-HDL simulation macro script files are included for instant evaluation of the IP core. All required files for simulation are included in the macro script. This simulation script can be used as a starting point of a user simulation project.

The evaluation test bench files are provided to show the DFI bus signal timing for typical memory access commands from the memory controller. These evaluation simulation files are made available only for the following memory settings: CL=5, AL=0, CWL=5. For any other memory setting values, the user is advised to refer to this user's guide and develop the corresponding simulation environment.

Note on Shortening Simulation Run Time

The DDR3 PHY IP core implements many timers to comply with JEDEC specifications. Due to these timers, the functional simulation takes a longer time at various stages of the simulation. In order to reduce the simulation run time, the IP core includes an option for lowering the timer counts, particularly on those timers used for waiting periods. This option can be enabled by adding a define SIM in the simulation script. It is important to note that this reduced timer value is valid for the simulation only and should not be included in the synthesis script.

Hardware Evaluation

The DDR3 PHY IP core supports Lattice's IP hardware evaluation capability, which makes it possible to create versions of the IP core that operate in hardware for a limited period of time (approximately four hours) without requiring the purchase of an IP license. It may also be used to evaluate the core in hardware in user-defined designs.

Enabling Hardware Evaluation in Diamond

Choose **Project > Active Strategy > Translate Design Settings**. The hardware evaluation capability may be enabled/disabled in the Strategy dialog box. It is enabled by default.

Regenerating/Recreating the IP Core

By *regenerating* an IP core with the Clarity Designer tool, you can modify any of the options specific to an existing IP instance. By *recreating* an IP core with Clarity Designer tool, you can create (and modify if needed) a new IP instance with an existing LPC/IPX configuration file.

Regenerating an IP Core in Clarity Designer Tool

To regenerate an IP core in Clarity Designer:

1. In the Clarity Designer Builder window, right-click on the existing IP instance and choose **Config**.
2. In the dialog box, choose the desired options.

For more information about the options, click **Help**. You may also click the **About** tab in the Clarity Designer window for links to technical notes and user guides. The IP may come with additional information. As the options

change, the schematic diagram of the module changes to show the I/O and the device resources the module will need.

3. Click **Configure**.

Recreating an IP Core in Clarity Designer Tool

To recreate an IP core in Clarity Designer:

1. In the Clarity Designer Catalog window, click the **Import IP** tab at the bottom.
2. In the Import IP tab, choose the existing IPX/LPC source file of the module or IP to regenerate.
3. Specify the instance name in **Target Instance**. Note that this instance name should not be the same as any of the existing IP instances in the current Clarity Design project.
4. Click **Import**. The module's dialog box opens showing the option settings.
5. In the dialog box, choose the desired options.

For more information about the options, click **Help**. You may also click the **About** tab in the Clarity Designer window for links to technical notes and user guides. The IP may come with additional information. As the options change, the schematic diagram of the module changes to show the I/O and the device resources the module will need.

6. Click **Configure**.

This chapter provides supporting information on using the DDR3 PHY IP core in complete designs.

Understanding Preferences

The generated preference file has many preferences that will fall mainly into one of these categories:

FREQUENCY Preferences

Each clock domain in the DDR3 PHY IP core is defined by a FREQUENCY preference.

MAXDELAY NET

The MAXDELAY NET preference ensures that the net has a minimal net delay and falls within the allowed limit. Since this preference is likely to be over-constrained, the post-route trace preference file should be used to validate the timing results.

MULTICYCLE / BLOCK PATH

The MULTICYCLE preference is applied to a path that is covered by the FREQUENCY constraint, but is allowed to be relaxed from its FREQUENCY constraint. The FREQUENCY constraint is relaxed in multiples of the clock period.

The BLOCK preference is applied to a path that is not relevant for the timing analysis.

IOBUF

The IOBUF preference assigns the required I/O types and attributes to the DDR3 I/O pads.

LOCATE

Only the em_dds_dqs pads and the PLL input clock pad are located in the provided preference file per user selection. Note that not all I/O pads can be associated with a DQS (em_dds_dqs) pad in a bank. Since there is a strict DQ-to-DQS association rule in each Lattice FPGA device, it is strongly recommended to validate the DQ-to-DQS associations of the selected pinouts using the implementation software before the PCB routing task is started. The DQ-to-DQS pad associations for a target FPGA device can be found in the data sheet or pinout table of the target device.

For more details on DDR3 pinout guidelines, refer to:

- TN1265, [ECP5 High-Speed I/O Interface](#)
- TN1180, [LatticeECP3 High-Speed I/O Interface](#)

Handling DDR3 PHY IP Preferences in User Designs

- The generated preference file uses the hierarchical paths for nets and cells. These paths are good for the evaluation environment provided by the IP package. When the DDR3 PHY IP core is integrated into the user design, all the hierarchical paths in the preference file should be updated per the user's integrated environment. In most cases, appending a wild case designation (such as "**/") in the beginning of the path name may be enough.
- The hierarchy structure and name of an internal net used in a preference is subject to change when there are changes in the design or when a different version of a synthesis tool is used. It is the user's responsibility to track these changes and update them in the preference file. The updated net and path names can be found in the map report file (.mrp) or through Floorplan View and Physical View in Diamond.
- If a preference has an incorrect path or name it is dropped by the Place and Route tool and the dropped preferences are listed in the static timing report (.twr file). It is important to check for such dropped preferences in the static timing report.

Reset Handling

The DDR3 PHY IP core provides two reset input ports at the local side. The `dfi_reset_n` signal by default resets both the IP core and the memory device. Usually this `dfi_reset_n` is expected to include `power_on_reset` as well as the system reset and is implemented through the global reset net (GSR) by default. Another reset input signal, `mem_rst_n`, is available to reset only the memory device, not the IP core. In addition to routing this reset to the memory, the IP core ensures that the memory reset signal `em_ddr_reset_n` is asserted at least for a 100 ns period as required by the JEDEC specification, even if the input reset signal `mem_rst_n` is asserted for less than 100 ns. The minimum required reset assertion time for `mem_rst_n` is one system clock.

The DDR3 PHY IP core, through the GUI option “Controller Reset to Memory” allows the user to disable both the `dfi_reset_n` or `mem_rst_n` inputs from resetting the memory (see [Controller Reset to Memory](#) for further information). When this option is disabled (unchecked) the memory side output port `em_ddr_reset_n` is removed from the IP core’s output ports. In this disabled mode, `dfi_reset_n` resets only the IP core. It is the user’s responsibility to implement a memory reset logic outside the IP core and also to add a port for the memory reset. In addition, the user memory reset signal generated outside the IP core must be fed to the `mem_rst_n` input of the IP core to let the core know the memory reset assertion. This will enable the IP core to set the memory interface signals at the appropriate state as specified for the reset time.

There may be many applications which need to handle the memory reset outside the IP core. For example, disabling the memory reset from the core can be useful when multiple host controllers need to be connected to and share a DDR3 memory.

Dummy Logic in IP Core Evaluation

When a DDR3 PHY IP core is generated, Clarity Designer assigns all the signals from both the DDR3 and DFI interfaces to the I/O pads. The number of the DDR3 PHY IP core’s DFI signals for read and write data buses together is normally closer to eight times that of the DDR3 memory interface. It is impossible for the IP core to be generated if the selected device does not have enough I/O pad resources. To facilitate the core evaluation with smaller package devices, Clarity Designer inserts dummy logic to decrease the I/O pad count by reducing the DFI side `read_data` and `write_data` bus sizes. With the dummy logic, a core can be successfully generated and evaluated even with smaller pad counts. The PAR process can be completed without a resource violation so that one can evaluate the performance and utilization of the IP core. However, the synthesized netlist will not function correctly because of the inserted dummy logic. The core with dummy logic, therefore, must be used only for evaluation.

Top-level Wrapper File Only for Evaluation Implementation

For evaluation implementation using the Verilog core, a separate top-level wrapper file, `ddr3_sdram_phy_top_wrapper.v` is provided in the directory `..\ddr_p_eval\\impl`. This wrapper file may have a reduced number of local side data buses for the reason mentioned in the previous paragraph. The evaluation par project file `<usr_name>_eval.syn` in the directory `..\ddr_p_eval\\impl\synplicity` (or `..\ddr_p_eval\\impl\precision`) points to this wrapper file for running the evaluation implementation.

For VHDL flow, the top-level wrapper file `..\ddr_p_eval\\impl\ddr3_sdram_phy_top_wrapper.vhd` is provided for evaluation implementation.

Note that this top-level wrapper file is not used for evaluation simulation.

Top-level Wrapper file for All Simulation Cases and Implementation in a User Design

In real applications, since back-end user logic design is attached to the core, most of the user side interface signals are connected within the FPGA fabric and will not be connected to the pads of the FPGA fabric. There is a main top level wrapper file, `ddr3_sdram_phy_top_wrapper.v` (.vhd), in the directory

`..\ddr_p_eval\. This wrapper is generated with full local side data bus and is meant for simulation as well as for the final integration with user's logic for synthesis. The user's par project file should point to this top-level wrapper file while implementing the IP core in the user's application.`

RDIMM Module Support

The DDR3 PHY IP core is designed to work with the default settings of the RDIMM module's SSTE32882 registering clock driver. There is no support from the IP core to program the control word registers of the clock driver.

A Note on Chip Select Signal Handling when a Single Rank RDIMM Module is Used: In order to set the RDIMM's clock driver in normal mode, the PHY IP provides two bits for the chip select signal `em_ddr_cs_n` and always drives `em_ddr_cs_n[1]` high. The user is advised to connect both chip select bits to the corresponding chip select input pins of the RDIMM module. Leaving the chip select bit 1 input of the RDIMM module open will lead to incorrect operation of the RDIMM module.

Netlist Simulation

The IP GUI automatically generates the netlist simulation scripts, `ddr3phy_gatesim_synplify.do` and/or `ddr3phy_gatesim_precision.do` file in the `..\ddr_p_eval\ directory only when there are enough pads in the selected target device to connect all the user-side signals of DDR3 PHY IP core. The generated simulation scripts are to perform the netlist simulation of the standalone DDR3 PHY IP in the core evaluation mode. Note that the generated scripts do not include the SDF back-annotation because of the large routing delays of the core's local signals to the I/O pads.`

When there are not enough I/O pads available in the selected target device to connect all the user side signals of DDR3 PHY IP, the IP GUI will not generate a netlist simulation script because the evaluation test bench cannot access all ports that are required to verify the functions of the implemented core.

The back-annotated netlist simulation of the DDR3 PHY IP with the SDF file (timing simulation), therefore, will work successfully only when a complete user design is attached to the IP core, which will properly terminate the core local signals providing complete functionality accesses from the user test bench environment.

The functionality of the DDR3 PHY IP core has been verified via simulation and hardware testing in a variety of environments, including:

- Simulation environment verifying proper DDR3 functionality when testing with the industry standard Denali MMAV (Memory Modeler - Advanced Verification) verification IP
- Hardware validation of the IP implemented on Lattice FPGA evaluation boards. Specific testing has included:
 - Verifying proper DDR3 protocol functionality using Lattice DDR3 Memory Controller
 - Verifying DDR3 electrical compliance using Lattice DDR3 Memory Controller.
- In-house interoperability testing with multiple DIMM modules

This chapter contains information about Lattice Technical Support, additional references, and document revision history.

Lattice Technical Support

Submit a technical support case via www.latticesemi.com/techsupport.

References

- TN1265, [ECP5 High-Speed I/O Interface](#)
- TN1180, [LatticeECP3 High-Speed I/O Interface](#)

Revision History

Date	Document Version	IP Core Version	Change Summary
October 2016	2.1	2.1	Updated Write Leveling description in the Initialization Module section.
			Updated Type Tab section. Added reference to the Initialization Module section in the description of write leveling.
			Added support for ECP5-5G (LFE5UM5G) devices.
			Updated Table 5-1 , File List. Revised Model Files mem_data_width.
			Updated Lattice Technical Support section.
October 2014	2.0	2.0	Added support for ECP5.
March 2012	01.1	1.1	Updated document with new corporate logo.
			Added support for Dual Rank memory.
			Added restricted netlist simulation capability.
			Updated Appendix B with reference to SSN guidelines for DQS pin placement.
			Added support for LatticeECP3-17EA-328 device.
			Added support for LatticeECP3 device speed grades: -6L, -7L, -8L and -9.
			Updated GUI screen shots
			Added 2T support
Removed references to ispLEVER design software.			
May 2011	01.0	1.0	Initial release.

Resource Utilization

This appendix gives resource utilization information for Lattice FPGAs using the DDR3 PHY IP core. The IP configurations shown in this appendix were generated using the IPexpress software tool. IPexpress is the Lattice IP configuration utility, and is included as a standard feature of the Diamond design tools. Details re-garding the usage of IPexpress can be found in the IPexpress and Diamond help systems. For more information on the Diamond design tools, visit the Lattice web site at: www.latticesemi.com/software.

ECP5 Devices

Table A-1. Performance and Resource Utilization¹

Parameters	Slices	LUTs	Registers	I/O ²	f _{MAX} (MHz) ³
Data Bus Width: 8 (x8)	688	942	736	42	400 MHz (800 Mbps)
Data Bus Width: 16 (x8)	809	1066	969	53	400 MHz (800 Mbps)
Data Bus Width: 24 (x8)	838	1039	1003	64	400 MHz (800 Mbps)
Data Bus Width: 32 (x8)	970	1140	1181	75	400 MHz (800 Mbps)
Data Bus Width: 40 (x8)	1094	1262	1355	86	400 MHz (800 Mbps)
Data Bus Width: 48 (x8)	1212	1358	1509	97	400 MHz (800 Mbps)
Data Bus Width: 56 (x8)	1284	1375	1687	108	400 MHz (800 Mbps)
Data Bus Width: 64 (x8)	1383	1434	1851	119	400 MHz (800 Mbps)
Data Bus Width: 72 (x8)	1518	1550	2021	130	333 MHz (666 Mbps)

1. Performance and utilization data are generated targeting an LFE5U/LFE5UM-85F-8BG756C device using Lattice Diamond 3.3 design software with an LFE5U/LFE5UM control pack. Performance may vary when using a different software version or targeting a different device density or speed grade within the ECP5 family.
2. Numbers shown in the I/O column represent the number of primary I/Os at the DDR3 memory interface. User interface (local side) I/Os are not included.
3. The DDR3 IP core can operate at 400 MHz (800 DDR3) in the fastest speed-grade (-8) when the data width is 64 bits or less and one chip select is used.

Ordering Part Number

The Ordering Part Number (OPN) for the DDR3 PHY IP on ECP5 devices is DDR3-PHYP-E5-U or DDR3-PHYP_E5_UT.

LatticeECP3 FPGAs

Table A-2. Performance and Resource Utilization^{1,2}

Parameter	Slices	LUTs	Registers	I/O	f _{MAX} (MHz) ³
Data Bus Width: 8 (x8)	702	929	822	42	400 MHz (800 Mbps)
Data Bus Width: 16 (x8)	871	1056	1127	53	400 MHz (800 Mbps)
Data Bus Width: 24 (x8)	1049	1181	1429	64	400 MHz (800 Mbps)
Data Bus Width: 32 (x8)	1223	1322	1739	75	400 MHz (800 Mbps)
Data Bus Width: 40 (x8)	1148	1322	1560	86	400 MHz (800 Mbps)
Data Bus Width: 48 (x8)	1263	1431	1742	97	400 MHz (800 Mbps)
Data Bus Width: 56 (x8)	1368	1517	1916	108	400 MHz (800 Mbps)
Data Bus Width: 64 (x8)	1472	1623	2091	119	400 MHz (800 Mbps)
Data Bus Width: 72 (x8)	1615	1728	2303	130	333 MHz (666 Mbps)

1. Performance and utilization data are generated targeting an LFE3-150EA-8FN1156C device using Lattice Diamond 1.4 software. Performance may vary when using a different software version or targeting a different device density or speed grade within the LatticeECP3 family.

2. LatticeECP3 'EA' silicon support only.

3. The DDR3 IP core can operate at 400 MHz (800 DDR3) in the fastest speed-grade (-8, -8L or -9) when the data width is 64 bits or less and one chip select is used.

Ordering Information

The Ordering Part Number (OPN) for the DDR3 PHY IP on LatticeECP3-EA devices is DDR3-PHY-E3-U.



Lattice Devices Versus DDR3 PHY IP Matrix

The maximum DDR3 bus datawidth supported in a device depends on the number of DQS groups available in that device. The available number of DQS groups in the left or right side varies with each LatticeECP3 or ECP5 device density and package.

While all the DQS groups fully support DDR3 electrical and protocol specifications, the user is recommended to consider Simultaneous Switching Noise (SSN) guidelines for the proper placement of the DQS pins.

These guidelines are driven by the following factors:

- Properly terminated interface
- SSN optimized PCB layout
- SSN considered I/O pad assignment
- Use of pseudo power pads

Technical notes TN1180, [LatticeECP3 High-Speed I/O Interface](#) and TN1265, [ECP5 High-Speed I/O Interface](#), provide detailed information on the SSN-considered I/O pad assignment and the use of pseudo power pads. These technical notes include a Recommended DQS Group Allocation table for each LatticeECP3 and ECP5 device and package. These tables can be used as baseline. You are advised to derive the best DQS placement for higher or lower data widths depending on the level of adherence to all the factors of the Simultaneous Switching Noise (SSN) guidelines.



LatticeECP3 DDR3 PHY IP

Locate Constraints

The DDR3 PHY IP core has a few critical macro-like blocks that require specific placement locations. This is achieved by adding a number of “LOCATE” constraints in the preference file for these blocks. There are two groups of locate constraints applied in the preference file.

- One group consists of a list of locate constraints for the read_pulse_delay logic. Each of these locate constraints corresponds to a particular DQS pin.
- One group consists of a list of locate constraints for the clock synchronization logic. Each clk_in pin has one group of these locate preferences.

As per the DQS pins and clk_in pin selected through the Pin Selection tab of the IPexpress GUI, the IP generation process automatically adds the corresponding locate constraints into the preference file (refer to the [Pin Selection Tab](#) section).

If the user decides to change any of the DQS pins or the clk_in pin, the IP core will need to be regenerated after selecting the new pins in the GUI. The new preference file will contain the new locate preferences.

The DQS and/or clk_in location change will require only a new set of locate preferences with no change in IP core functionality. Alternatively, the user may regenerate the IP core in a different project directory and copy only these locate preferences from the new preference file into the preference file in the current working directory.

As mentioned previously, for the selected clock input pin, the IP core generation process automatically adds the corresponding locate constraints into the preference file. This clock input pin is the dedicated PLL clock input pin for a particular PLL. In the Pin Selection tab of the DDR3 PHY IP core GUI, only one clock input pin is available in the left and right side of the selected device. The user has the option to select an alternative clock input pin per side which is not shown in the GUI. This second clock input pin is a dedicated clock input of another PLL in the same side.

To use this additional clock input pin, the user must manually edit the generated preference file by replacing the locations of a few locate constraints. The following tables show the locations for each of those available second clock input pins. Note that there are no additional clock input pins available in LatticeECP3-17 devices.

Table A-1. DDR3 Configurations Versus Device Matrix for Right side DDR3 I/Os

Site	Comp.	LatticeECP3-150		LatticeECP3-95		
Left Side 2nd Clock Input	CLKI	FPBGA1156	FPBGA672	FPBGA1156	FPBGA672	FPBGA484
		Y9	U4	Y9	U4	T3
	PLL	R79C5	R79C5	R61C5	R61C5	R61C5
	sync	LECLKSYNC1	LECLKSYNC1	LECLKSYNC1	LECLKSYNC1	LECLKSYNC1
	clk_phase0	R78C5D	R78C5D	R60C5D	R60C5D	R60C5D
	clk_phase1a	R60C2D	R60C2D	R42C2D	R42C2D	R42C2D
	clk_phase1b	R60C2D	R60C2D	R42C2D	R42C2D	R42C2D
clk_stop	R60C2D	R60C2D	R42C2D	R42C2D	R42C2D	

Site	Comp.	LatticeECP3-70			LatticeECP3-35		
Left Side 2nd Clock Input	CLKI	FPBGA1156	FPBGA672	FPBGA484	FPBGA672	FPBGA484	FTBGA256
		Y9	U4	T3	U4	T3	P2
	PLL	R61C5	R61C5	R61C5	R53C5	R53C5	R53C5
	sync	LECLKSYNC1	LECLKSYNC1	LECLKSYNC1	LECLKSYNC1	LECLKSYNC1	LECLKSYNC1
	clk_phase0	R60C5D	R60C5D	R60C5D	R52C5D	R52C5D	R52C5D
	clk_phase1a	R42C2D	R42C2D	R42C2D	R34C2D	R34C2D	R34C2D
	clk_phase1b	R42C2D	R42C2D	R42C2D	R34C2D	R34C2D	R34C2D
clk_stop	R42C2D	R42C2D	R42C2D	R34C2D	R34C2D	R34C2D	

Site	Comp.	LatticeECP3-150			LatticeECP3-95		
Right Side 2nd Clock Input	CLKI	FPBGA1156	FPBGA672	FPBGA1156	FPBGA672	FPBGA484	
		Y28	V20	Y28	V20	R17	
	PLL	R79C178	R79C178	R61C142	R61C142	R61C142	
	sync	RECLKSYNC1	RECLKSYNC1	RECLKSYNC1	RECLKSYNC1	RECLKSYNC1	
	clk_phase0	R78C178D	R78C178D	R60C142D	R60C142D	R60C142D	
	clk_phase1a	R60C181D	R60C181D	R42C145D	R42C145D	R42C145D	
	clk_phase1b	R60C181D	R60C181D	R42C145D	R42C145D	R42C145D	
clk_stop	R60C181D	R60C181D	R42C145D	R42C145D	R42C145D		

Site	Comp.	LatticeECP3-70			LatticeECP3-35		
Right Side 2nd Clock Input	CLKI	FPBGA1156	FPBGA672	FPBGA484	FPBGA672	FPBGA484	FTBGA256
		Y28	V20	R17	V20	R17	T15
	PLL	R61C142	R61C142	R61C142	R53C70	R53C70	R53C70
	sync	RECLKSYNC1	RECLKSYNC1	RECLKSYNC1	RECLKSYNC1	RECLKSYNC1	RECLKSYNC1
	clk_phase0	R60C142D	R60C142D	R60C142D	R52C70D	R52C70D	R52C70D
	clk_phase1a	R42C145D	R42C145D	R42C145D	R34C73D	R34C73D	R34C73D
	clk_phase1b	R42C145D	R42C145D	R42C145D	R34C73D	R34C73D	R34C73D
clk_stop	R42C145D	R42C145D	R42C145D	R34C73D	R34C73D	R34C73D	