







Lose mitgeliefert: /
separately enclosed:

-  4 x Zylinderschraube M4x10 /
4 x fillister head cap screw M4x10
-  4 x Zylinderschraube M5x12 /
4 x fillister head cap screw M5x12
-  4 x Sperrkantscheibe SK S4 /
4 x washer M4
-  4 x Sperrkantscheibe SK S5 /
4 x washer M5

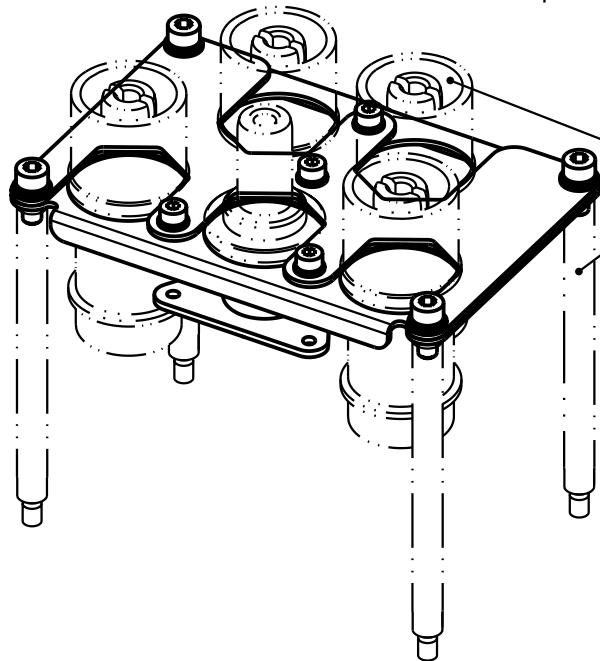

nicht im Lieferumfang enthalten/
not range of delivery

 All Dimensions in mm Original Size DIN A 4		Techn. Character.			Nicht tolerierte Masse/ Free size tolerances	
			Dat.	Name	Maßstab/Scale 1:2	Halterung Han 5HC-M 350A Frame Han 5HC-M 350A Han 48HPR-asw
		Detail.	06.02.04	Ho		
		Insp.		OLE		
		Stand.				
410968	20.04.04	Loe.	HARTING Electric GmbH & Co. KG		TB 09 40 048 9809	Blatt/ page
410876			D-32339 Espelkamp			
Mod.	Dat.	Name			Sub.	