

PRODUCT NUMBER SEE SHEET 2

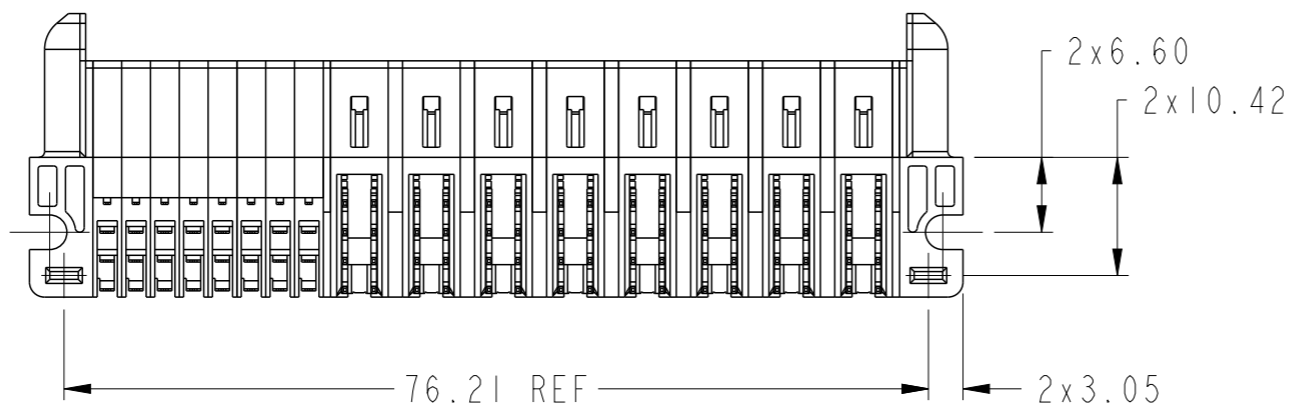
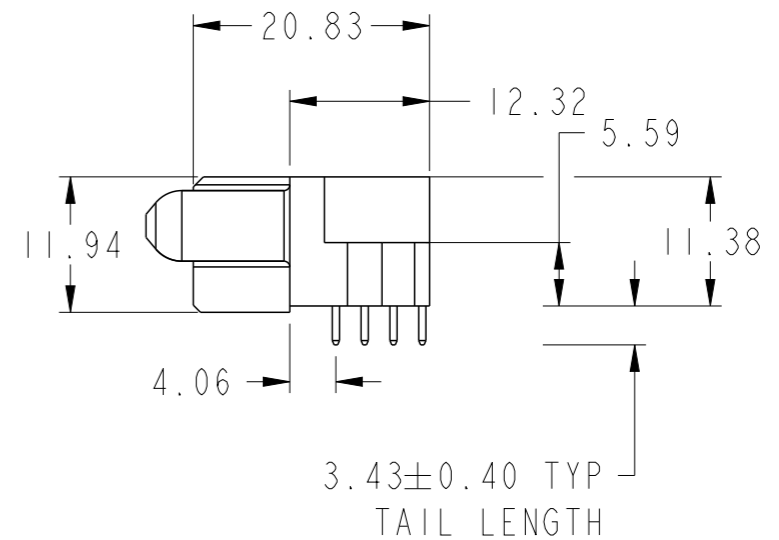
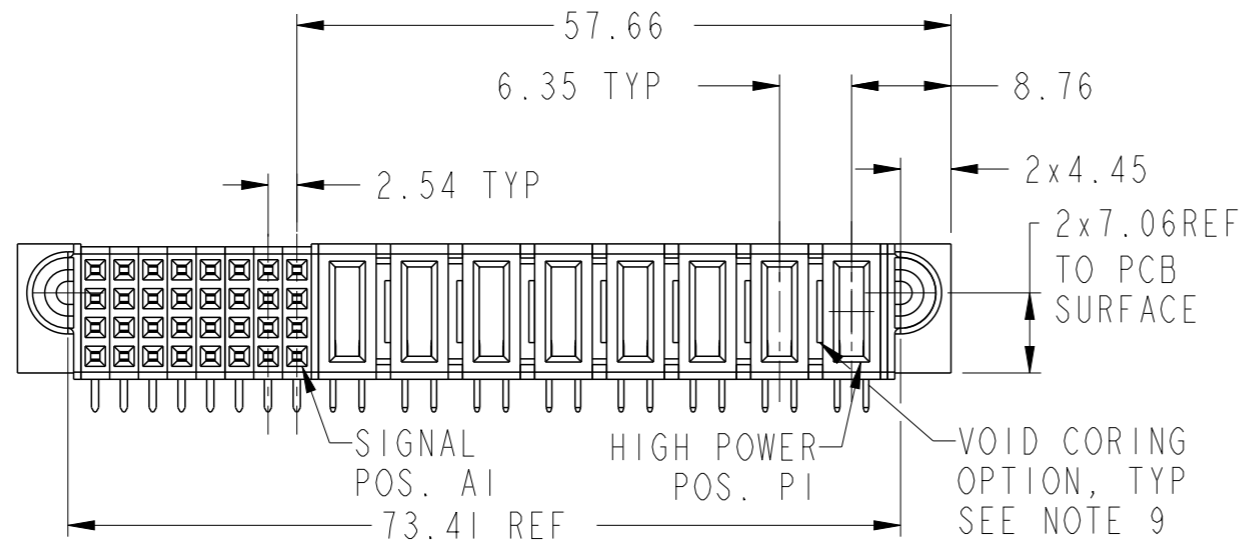
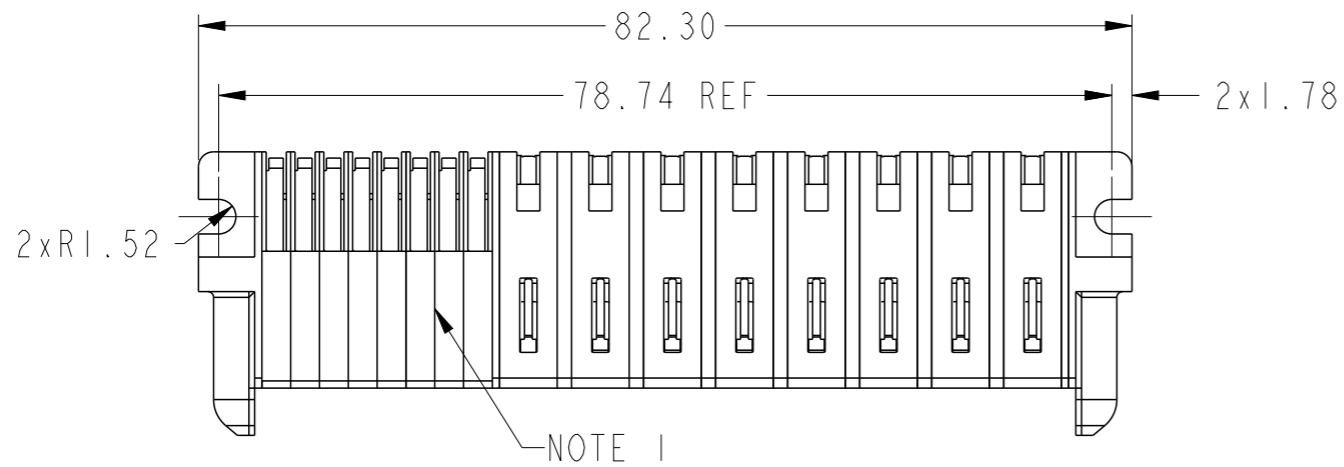

spec ref	*	dr	Rainbow Zhan	2014/07/03	projection	MM	size	A3	scale	3:2
tolerance std	ASME Y14.5	eng	Rainbow Zhan	2014/07/10			ecn no	-	rel level	Released
TOLERANCES UNLESS OTHERWISE SPECIFIED		chr	Li-He	2014/07/09						
surface	✓	appr	Pei-Ming Zheng	2014/07/10			cat. no.	8HP + 32S	dwg no	10106126-8008001
ASME Y14.5	linear	0.X	±0.5	www.fci.com	RA STB RECEPTACLE		rev	A	Product - Customer Drw	
	angular	0°	±2°		Product - Customer Drw		sheet 1 of 3			

Copyright FCI.
FCI

PRODUCT NO.	ROWS	SIGNAL								HIGH POWER									
		E1	8	7	6	5	4	3	2	1	P8	P7	P6	P5	P4	P3	P2	P1	E2
10106126-8008001LF	D C B A	H	H	H	H	H	H	H	H	H	H1	H3	H3	H3	H3	H3	H3	H3	H3
		G	G	G	G	G	G	G	G	G									
		F	F	F	F	F	F	F	F	F									
		E	E	E	E	E	E	E	E	E									

CODE	DESCRIPTION
E	STD SIGNAL CONTACT, ROW A
F	STD SIGNAL CONTACT, ROW B
G	STD SIGNAL CONTACT, ROW C
H	STD SIGNAL CONTACT, ROW D
H1	MFBL HIGH POWER CONTACT(3.43)
H3	STD HIGH POWER CONTACT(3.43)

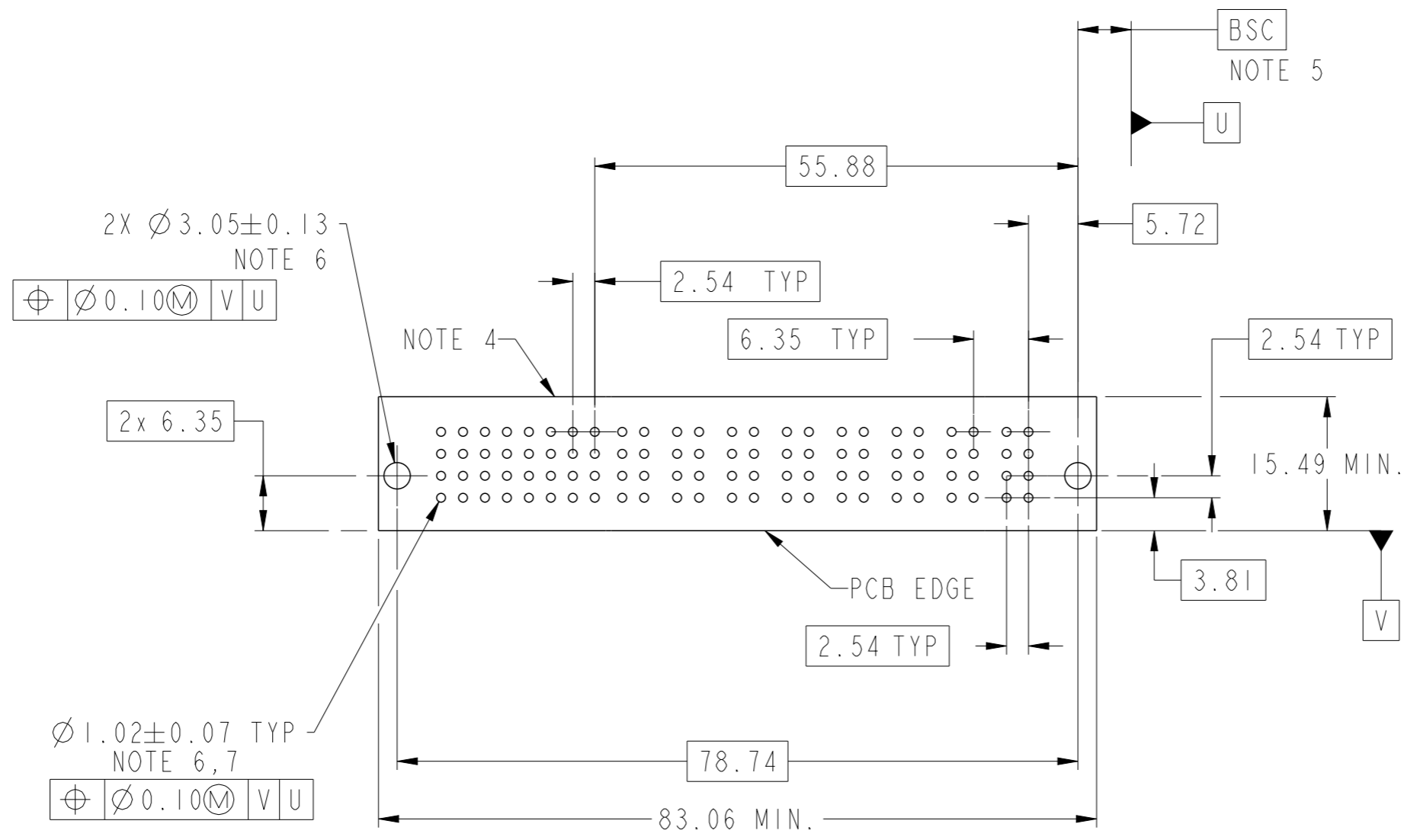



dr	Rainbow Zhan	2014/07/03	projection	MM	size	A3	scale	3:2
eng	Rainbow Zhan	2014/07/10			ecn no		-	
chr	Li-He	2014/07/09			rel level		Released	
appr	Pei-Ming Zheng	2014/07/10	product family		PwrBlade+		Released	
			title		8HP + 32S		rev	
www.fci.com			cat. no.		Product - Customer Drw		sheet 2 of 3	
			title		RA STB RECEPTACLE		rev	
			dwg no		10106126-8008001		A	



Copyright FCI.

NOTES:

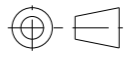
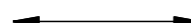
- 1) "FCI", PART NUMBER AND DATE CODE TO BE MARKED ON THIS SURFACE.
THE MARK CAN BE OMITTED IF THERE IS NOT ENOUGH SPACE ON THIS SURFACE.
- 2) MATERIALS:
-HOUSING - GLASS FILLED WITH HIGH TEMP THERMOPLASTIC, UL94V-0.
-SIGNAL CONTACT - COPPER ALLOY.
-POWER CONTACT - HIGH CONDUCTIVITY COPPER ALLOY.
- 3) PLATING SPECIFICATION REFER TO FCI 10116351
- 4) DENOTES CONNECTOR KEEP OUT ZONE.
- 5) DATUM AND BASIC DIMENIONS WERE ESTABLISHED BY CUSTOMER.
- 6) ALL HOLE DIAMETERS ARE FINISHED HOLE SIZES.
- 7) 1.15 ± 0.025 MM DRILLED HOLE PLATED WITH 0.00762MM MIN Sn
OVER 0.0254-0.0762MM Cu PLATING TO ACHIEVE A 1.02 ± 0.07 MM HOLE.
- 8) PRODUCT SPECIFICATION REFER TO FCI GS-12-658.
APPLICATION SPECIFICATION REFER TO FCI GS-20-141.
PRODUCT PACKAGED IN TRAYS, REFER TO FCI GS-14-1502.
- 9) THE VOID CORING IN BETWEEN POWER MODULES, SIGNAL
MODULES AND END MODULES ARE OPTIONAL AND THE SHAPE
MAY BE DIFFERENT FOR OPTIMIZE THE MOLDING PROCESS. THE
VOID CORING WILL NOT EFFECT TO PRODUCT FUNCTION.

dr	Rainbow Zhan	2014/07/03	projection 	MM 	size	A3	scale	3:2
eng	Rainbow Zhan	2014/07/10			ecn no	-		
chr	Li-He	2014/07/09			rel level	Released		
appr	Pei-Ming Zheng	2014/07/10			product family	PwrBlade+		
		title 8HP + 32S RA STB RECEPTACLE	dwg no 10106126-8008001	rev A				
www.fci.com		cat. no.	Product - Customer Drw		sheet 3 of 3			



Copyright FCI.