

PRODUCT NUMBER BPS8B96ZZD-CO--LF

WITH "LF" SUFFIX	LEAD FREE OR RoHS COMPATIBLE PRODUCT
WITHOUT SUFFIX	LEADED PRODUCT

WIRE ACCOMODATION		
PRODUCT NUMBER	WIRE SIZE	CONTACT IDENTIFICATION
BPS8B96ZZD0CO--	AWG28/30	0
BPS8B96ZZD2CO--	AWG24/26	2

CONTACT PLATING	
PRODUCT NUMBER	PERFORMANCE LEVEL PER DIN41612
Z0	CLASS 3
Z1	CLASS 2
E9	CLASS 1

NOTES:-
 1. THE "LF" PRODUCTS MEET EUROPEAN UNION DIRECTIVES AND OTHER COUNTRY REGULATIONS AS DESCRIBED IN GS-22-008
 2. LEAD FREE OR RoHS DIRECTIVE LABELING TO BE PROVIDED AS PER GS-14-920 FOR RoHS COMPATIBLE VERSION.

PERFORMANCES CHARACTERISTICS

VOLTAGE RATING : 250 VAC (rms)
 CURRENT RATING : 1,5 A AT 25 °C, 1 A AT 70 °C.
 INSULATION RESISTANCE : 1000 MΩ INITIAL, 100 MΩ MIN. AFTER TEST
 DIELECTRIC WITHSTANDING VOLTAGE : 1000 VAC (rms).
 CONTACT RESISTANCE : 15 mΩ MAX. INITIAL, 5 mΩ MAX. RISE OF INITIAL VALUE AFTER TEST.
 OPERATING TEMPERATURE*: -40 °C TO +125 °C.
 INSERTION FORCE : 1 N MAX./CONTACT.
 WITHDRAWAL FORCE : 0,2 N MIN./CONTACT.

*DEPENDING ON THE CABLE, THE MAX. TEMPERATURE CAN BE LOWER.
 FOR STANDARD PVC INSULATED CABLE : 105 °C MAX.

CONSTRUCTION

BODY MATERIAL : GLASS-REINFORCED THERMOPLASTIC (UL94V-0).
 COVER MATERIAL : POLYPHENYLENE (PPO), COLOUR : BLACK.
 CONTACT MATERIAL : PHOSPHOR BRONZE.
 CONTACT FINISH : Au OVER Ni IN CONTACT AREA.
 SnPb ON I.D.C. TERMINAL FOR LEADED PRODUCTS
 Sn (MATTE TIN) ON I.D.C TERMINAL FOR LEAD FREE PRODUCTS

Z0 : PERFORMANCE LEVEL PER DIN41612 CLASS 3
 Z1 : PERFORMANCE LEVEL PER DIN41612 CLASS 2
 E9 : PERFORMANCE LEVEL PER DIN41612 CLASS 1
 OTHERS : CONSULT FCI

TIE-WRAP : OPTIONAL (PART N°. TF4)

PART NUMBERS

BPS8B96ZZD0CO-- CONNECTOR FOR WIRE SIZE AWG28, AWG30. (CONTACT IDENTIFICATION : 0).
 BPS8B96ZZD0CO--LF CONNECTOR FOR WIRE SIZE AWG28, AWG30. (CONTACT IDENTIFICATION : 0).
 BPS8B96ZZD2CO-- CONNECTOR FOR WIRE SIZE AWG24, AWG26 (CONTACT IDENTIFICATION : 2).
 BPS8B96ZZD2CO--LF CONNECTOR FOR WIRE SIZE AWG24, AWG26 (CONTACT IDENTIFICATION : 2).

AWG WIRE SIZE MARKING

BPS8B96ZZD0CO-- : 28/30.
 BPS8B96ZZD0COLF-- : 28/30.
 BPS8B96ZZD2CO-- : 24/26.
 BPS8B96ZZD2COLF-- : 24/26.

DATECODE MARKING

A+ YEAR & WEEKCODE, EXAMPLE : F9950.

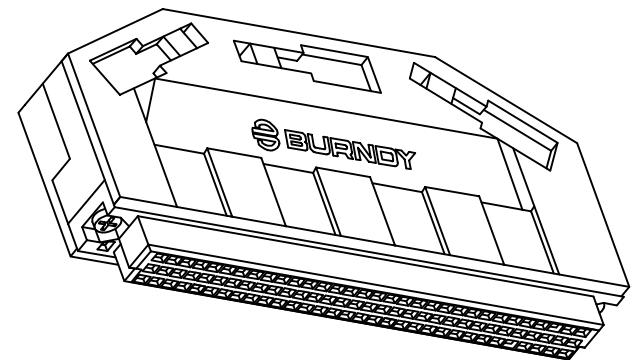
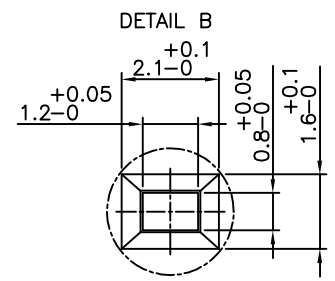
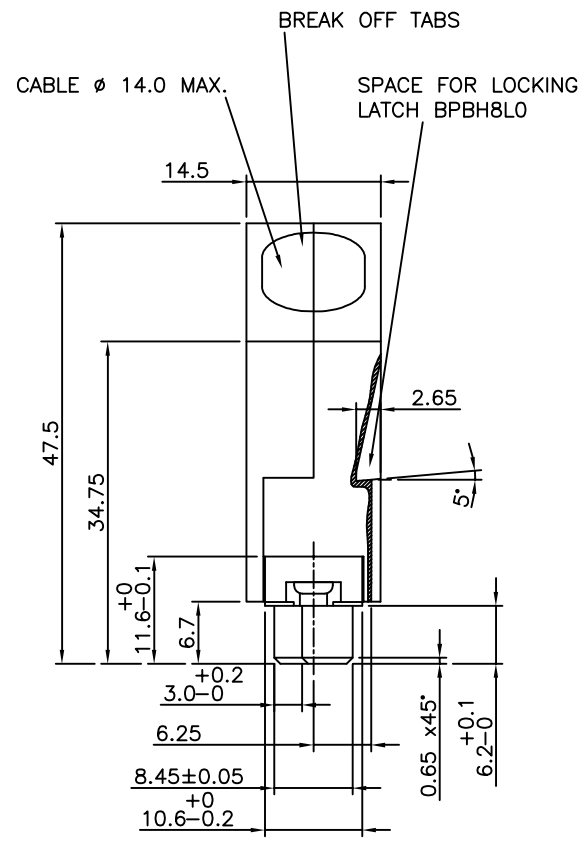
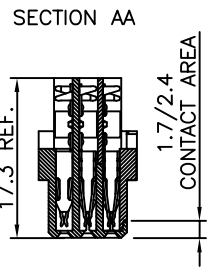
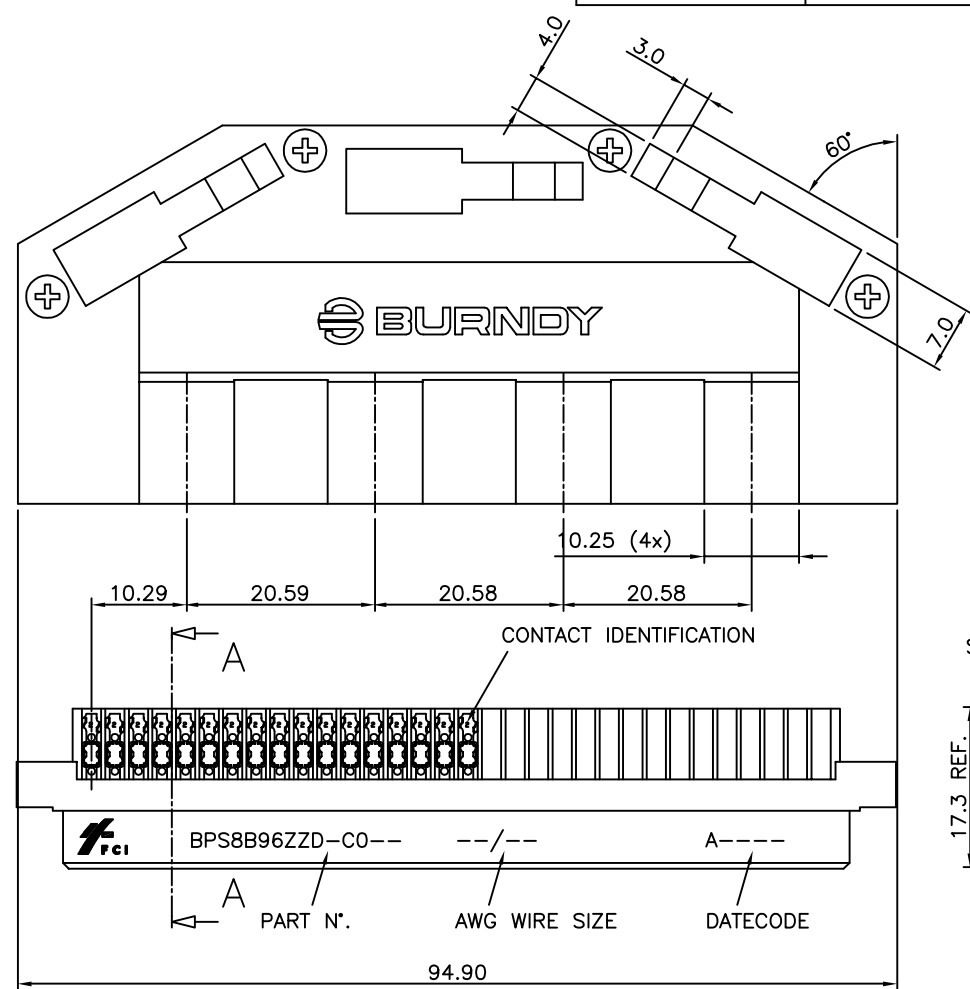

CONTACT ARRANGEMENT

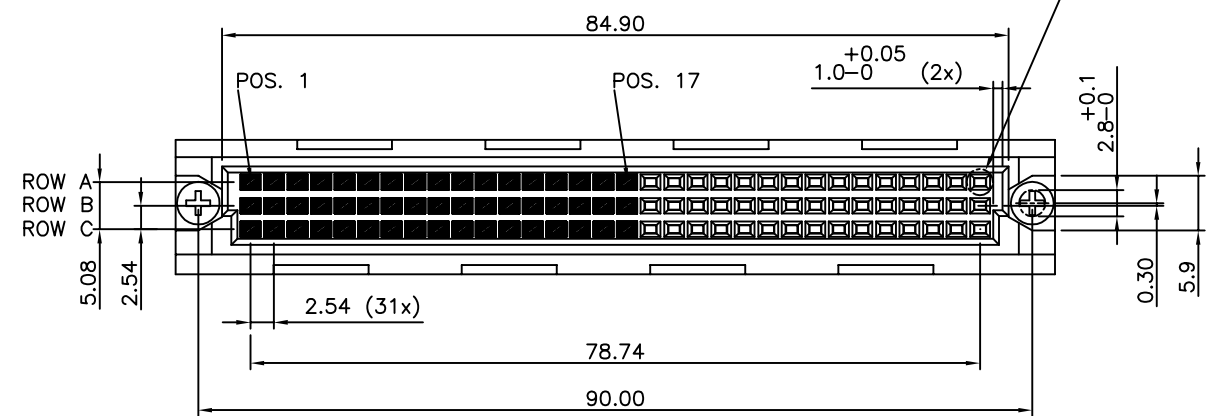
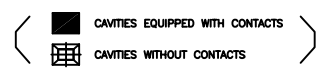

mat'l. code		surface		tolerance		projection		product family	
SEE NOTE		ISO 1302		ISO 406 ISO 1101		mm		BPS8	
litr ecn no dr date		tolerances unless otherwise specified		angles linear		mm		title	
A F00819 DLE 2000-10-23				±1°		mm		ASSY BPS8	
B 105-0156 MINI 2005-09-06						scale -		96 POS. A,C LOADED SPECIAL	
C 106-0067 MINI 2006-06-01								dwg no sheet 1 of 1 size	
		dr D.LEGRAND 2000-10-23				FCI		55369 A3	
		enr J.F.NOTTEAU 2000-10-23						type Product Customer Drawing	
		chr RAKHEE GEORGE 2006-06-01							
		appd RAKHEE GEORGE 2006-06-01							
sheet index		revision sheet		C 1					



Copyright FCI