

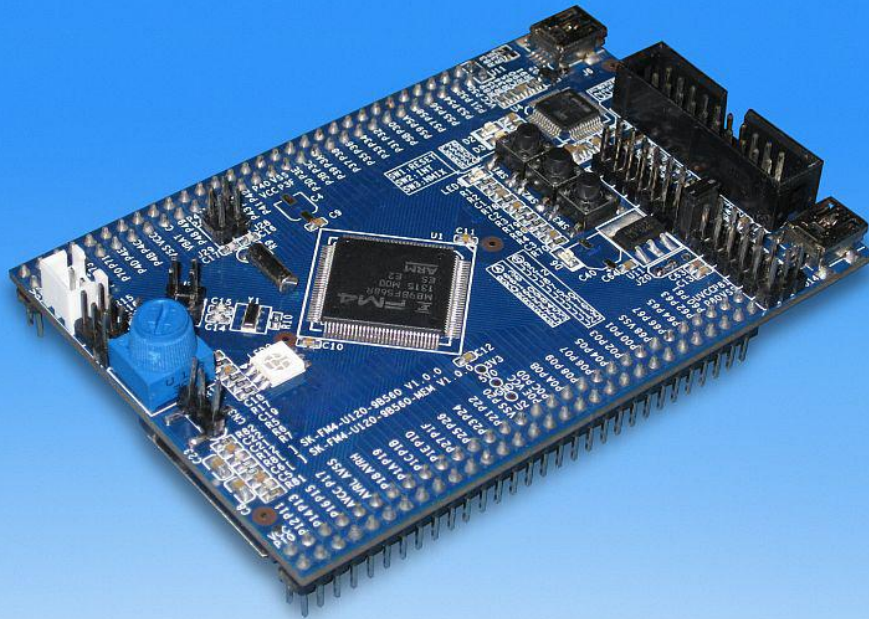

CYPRESS®

Embedded in Tomorrow™



Starter kit User Guide

SK-FM4-U120-9B560

SK-FM4-U120-9B560-MEM

Hardware V1.1 / Documentation V1.7

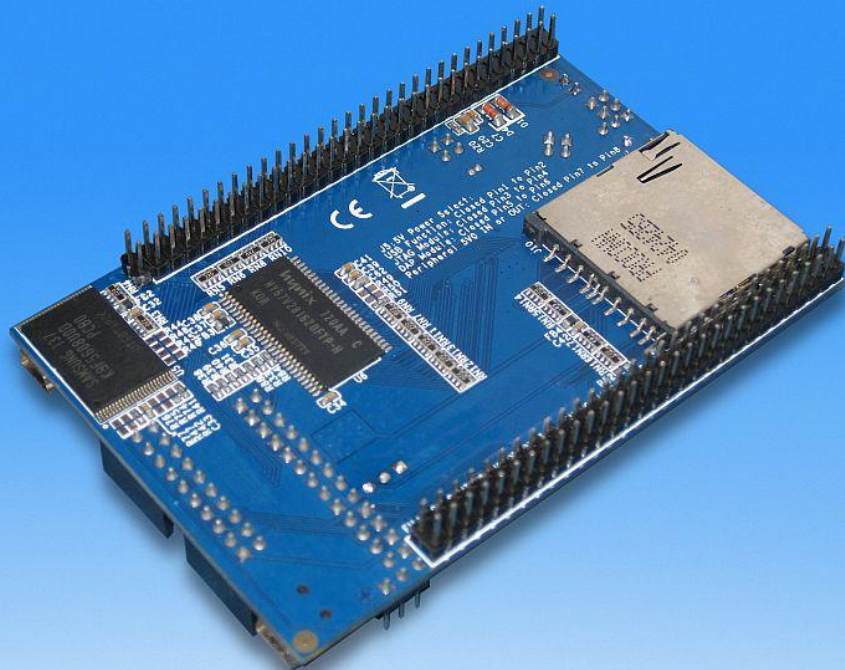

Document Number: 002-09878 Rev. *A

Warranty and Disclaimer



© Cypress Semiconductor Corporation, 2015-2016. This document is the property of Cypress Semiconductor Corporation and its subsidiaries, including Spansion LLC (“Cypress”). This document, including any software or firmware included or referenced in this document (“Software”), is owned by Cypress under the intellectual property laws and treaties of the United States and other countries worldwide. Cypress reserves all rights under such laws and treaties and does not, except as specifically stated in this paragraph, grant any license under its patents, copyrights, trademarks, or other intellectual property rights. If the Software is not accompanied by a license agreement and you do not otherwise have a written agreement with Cypress governing the use of the Software, then Cypress hereby grants you a personal, non-exclusive, nontransferable license (without the right to sublicense) (1) under its copyright rights in the Software (a) for Software provided in source code form, to modify and reproduce the Software solely for use with Cypress hardware products, only internally within your organization, and (b) to distribute the Software in binary code form externally to end users (either directly or indirectly through resellers and distributors), solely for use on Cypress hardware product units, and (2) under those claims of Cypress’s patents that are infringed by the Software (as provided by Cypress, unmodified) to make, use, distribute, and import the Software solely for use with Cypress hardware products. Any other use, reproduction, modification, translation, or compilation of the Software is prohibited.

TO THE EXTENT PERMITTED BY APPLICABLE LAW, CYPRESS MAKES NO WARRANTY OF ANY KIND, EXPRESS OR IMPLIED, WITH REGARD TO THIS DOCUMENT OR ANY SOFTWARE OR ACCOMPANYING HARDWARE, INCLUDING, BUT NOT LIMITED TO, THE IMPLIED WARRANTIES OF MERCHANTABILITY AND FITNESS FOR A PARTICULAR PURPOSE. To the extent permitted by applicable law, Cypress reserves the right to make changes to this document without further notice. Cypress does not assume any liability arising out of the application or use of any product or circuit described in this document. Any information provided in this document, including any sample design information or programming code, is provided only for reference purposes. It is the responsibility of the user of this document to properly design, program, and test the functionality and safety of any application made of this information and any resulting product. Cypress products are not designed, intended, or authorized for use as critical components in systems designed or intended for the operation of weapons, weapons systems, nuclear installations, life-support devices or systems, other medical devices or systems (including resuscitation equipment and surgical implants), pollution control or hazardous substances management, or other uses where the failure of the device or system could cause personal injury, death, or property damage (“Unintended Uses”). A critical component is any component of a device or system whose failure to perform can be reasonably expected to cause the failure of the device or system, or to affect its safety or effectiveness. Cypress is not liable, in whole or in part, and you shall and hereby do release Cypress from any claim, damage, or other liability arising from or related to all Unintended Uses of Cypress products. You shall indemnify and hold Cypress harmless from and against all claims, costs, damages, and other liabilities, including claims for personal injury or death, arising from or related to any Unintended Uses of Cypress products.

Cypress, the Cypress logo, Spansion, the Spansion logo, and combinations thereof, WICED, PSoC, CapSense, EZ-USB, F-RAM, and Traveo are trademarks or registered trademarks of Cypress in the United States and other countries. For a more complete list of Cypress trademarks, visit cypress.com. Other names and brands may be claimed as property of their respective owners.

- For your convenience this user guide includes external links that simplify installing of drivers, software utilities, and quick jumps to documentation.
- Some PDF viewer do not allow access to external content by links because of security reasons.
- A viewer called “PDF XChange” is provided in the software package of this starter kit. It’s use is free of charge and no additional installation is required.
- Launching “start.bat” opens this user guide in the PDF XChange viewer.
- Please ensure you have copied the complete software package related to this starter kit in order to use and run the links and examples given on the next pages.
- Please contact the [Cypress Support](#) in case of any question.

- [MCU Features](#), [Board Features](#) & [Contents](#)
- [Please check jumper setting](#) / [Test it by a GUI](#)
- [The Hardware](#) / [Pin Overview](#)
- [The Jumper Table](#) / [Jumper Default](#)
- [Board Power](#)
- [Software Examples & Tools](#)
- [Flash Programming](#)
- [JTAG / CMSIS-DAP](#)
- [IAR-Embedded Workbench](#)
- [KEIL \$\mu\$ Vision](#)
- [Contacts](#) & [More](#)

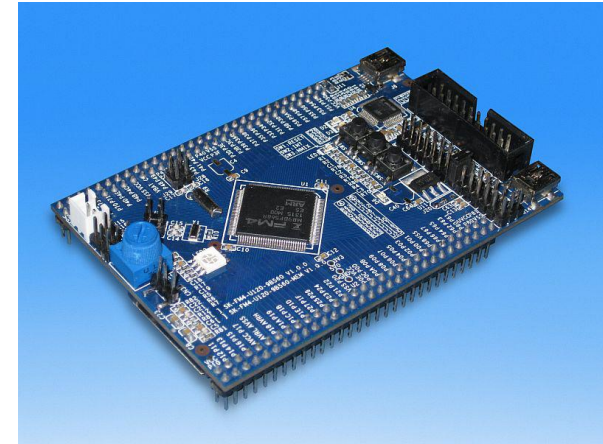

■ [Additional documents](#)

- [Schematic](#)
- [Factsheet](#)
- [Data sheet MB9B560R Series](#) and [Errata](#)
- [Peripheral Manual](#) and [Errata](#)
- [Peripheral Manual \(Timer Part\)](#) and [Errata](#)
- [Peripheral Manual \(Analog Part\)](#)
- [Peripheral Manual \(Communication Part\)](#) and [Errata](#)
- [Flash Programming Manual](#) and [Errata](#)

Please visit www.cypress.com to find latest releases of the above mentioned documents.

Features of the microcontroller

- The SK-FM4-U120-9B560 and SK-FM4-U120-9B560-MEM are based on the Cypress ARM[®] Cortex[®]-M4 device MB9BF568R
- The MB9B560R Series includes the following features:
 - Up to 1 MByte Flash Memory and 32 KByte Work Flash Memory
 - Up to 128 KByte RAM
 - Up to 160MHz clock
 - Up to 2 CAN controller 2.0A/B
 - Up to 8 UART / LIN / SPI / I²C interfaces
 - USB-Host/-Device interface
 - SD-Card interface
 - Three 12 bit ADCs, up to 24 channels
 - Two 12 bit DACs
 - Up to 16 channel external interrupts
 - Two Multifunction timer with waveform generator, e.g. Motor control
 - Timers (ICUs, OCUs, PPGs, others)

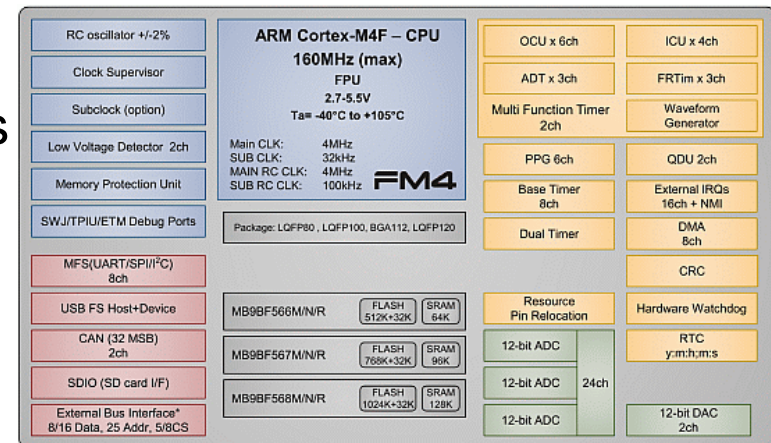

Features of the board

- The SK-FM4-U120-9B560(-MEM) is available in two versions:

Feature	SK-FM4-U120-9B560	SK-FM4-U120-9B560-MEM
External Power Supply	USB, DAP, JTAG or from SK-FM4-U-PERIPHERAL	
On-board Voltage	3.3V or 5V	3.3V
User-LEDs, Reset-LED	3x User-LEDs (R,G,B) + Reset	
Buttons	3x buttons: Reset + External Interrupt + NMI	
Potentiometer	AN18 (0V .. On-board voltage 3.3V/5V)	
Debug interface	On-board CMSIS-DAP incl. Status LEDs (connected, running) (optional 20 pin JTAG-IF to be used with external JTAG adapter)	
Virtual COM port (USB-2-UART bridge)	Yes	
USB interface	USB Function (Mini-USB Type B)	
SD-Card interface	Yes	No
External Memory	No	NAND-Flash: 32MByte SDRAM: 16MByte

Contents SK-FM4-U120-9B560

- The SK-FM4-U120-9B560(-MEM) contents
 - The SK-FM4-U120-9B560 or SK-FM4-U120-9B560-MEM evaluation board
 - One USB mini cable
 - 1-page flyer

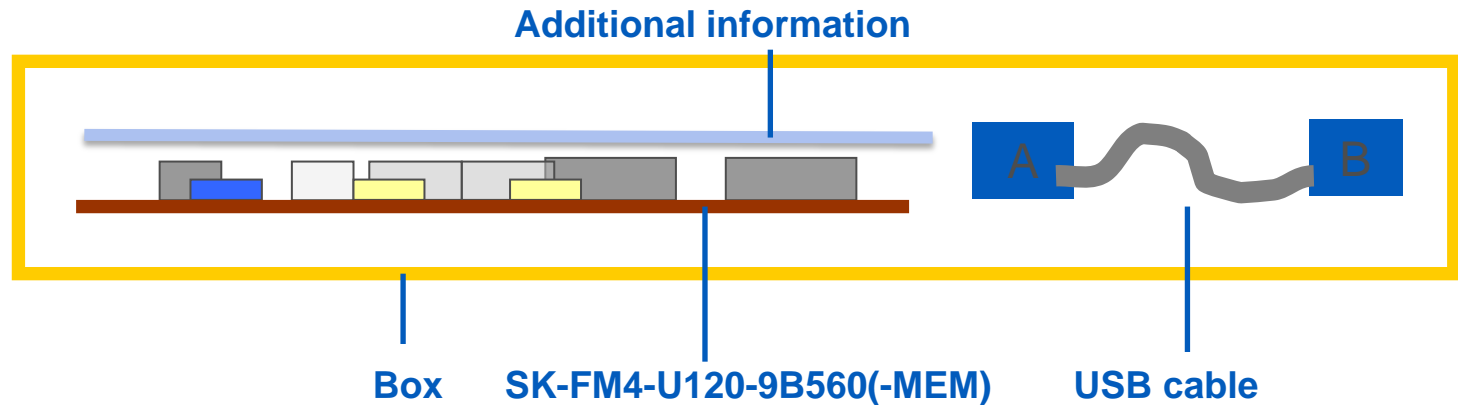

Please check jumper setting

SK-FM4-U120-9B560 supports 5V and 3.3V operation
SK-FM4-U120-9B560-MEM supports only 3.3V operation

Note:

Please set **J9 (USB)** instead of **J7 (CMSIS-DAP)**
Please set **J19 and J20:1-2 (SINO/SOTO)**

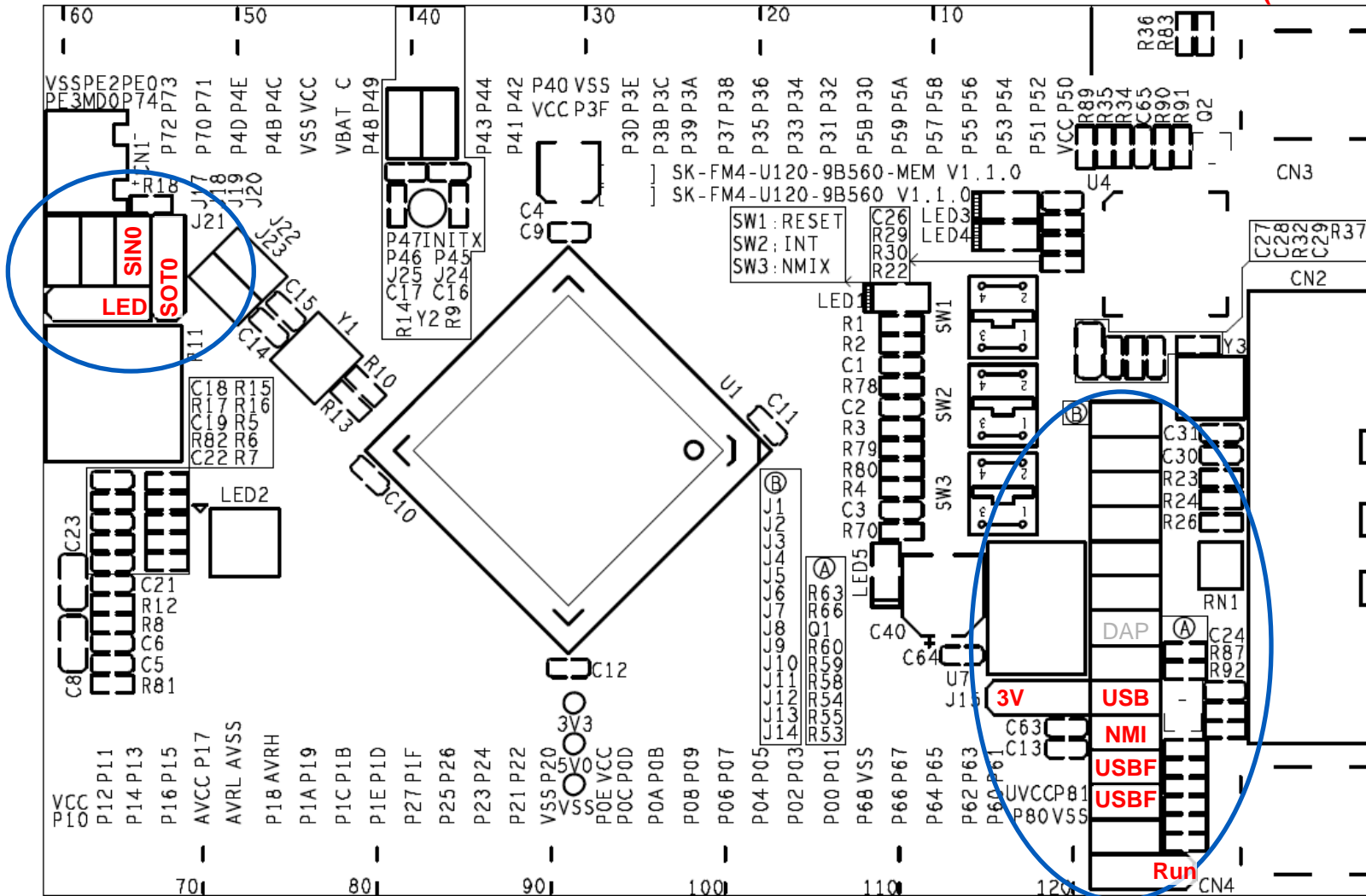

Test it by terminal using USB

- The microcontroller on the SK-FM4-U120-9B560(-MEM) is already preprogrammed with a test application (<drive:>\sw-examples\testsoftware)
 - Install the USB driver first <drive:>\drivers\driverinstaller.exe
 - Connect the starter kit to CN4 (USB) with your PC
 - ✓ Ensure jumper J9 (USB) is set for correct power supply
 - ✓ Ensure jumper J19 and J20:1-2 are set correctly for use of SIN0/SOT0
 - Press the ,Reset'- Button
 - Check the availability for virtual COM port
 - ✓ e.g. Windows Device Manager
 - Open a serial terminal tool
 - ✓ e.g. Cypress Serial Port Viewer
 - <drive:>\tools\serialportviewer\setup.exe
 - ✓ Settings 115200 baud, 8N1
 - Press <space> to show welcome menu
 - Please select any function to test the on-board features

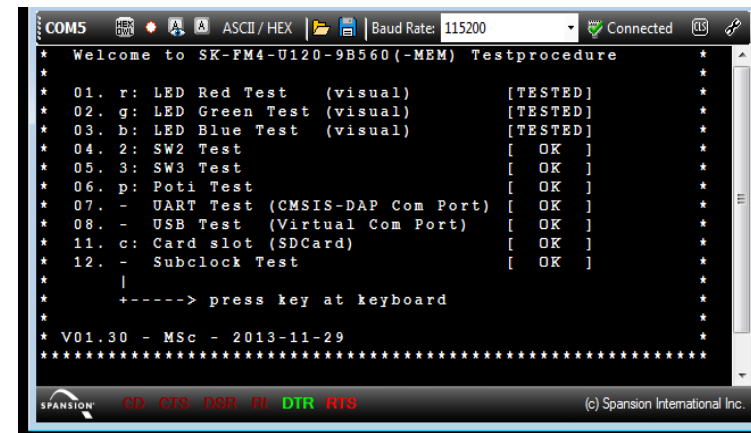
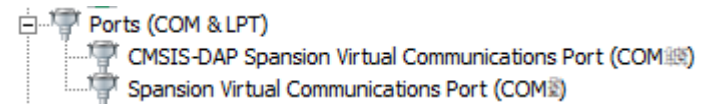

```
COM5  Baud Rate: 115200  Connected
* Welcome to SK-FM4-U120-9B560(-MEM) Testprocedure *
* 01. r: LED Red Test (visual) [TESTED] *
* 02. g: LED Green Test (visual) [TESTED] *
* 03. b: LED Blue Test (visual) [TESTED] *
* 04. 2: SW2 Test [ OK ] *
* 05. 3: SW3 Test [ OK ] *
* 06. p: Pot1 Test [ OK ] *
* 07. - UART Test (CMSIS-DAP Com Port) [ OK ] *
* 08. - USB Test (Virtual Com Port) [ OK ] *
* 11. c: Card slot (SDCard) [ OK ] *
* 12. - Subclock Test [ OK ] *
* | *
* +-----> press key at keyboard *
* *
* V01.30 - MSc - 2013-11-29 *
*****
SPANSION CD CTS DSR RI DTR RTS (c) Spansion International Inc.
```

Test it by a GUI

- The microcontroller on the SK-FM4-U120-9B560(-MEM) is already preprogrammed with a test application (<drive:>\sw-examples\testsoftware)
 - Install the USB driver first <drive:>\drivers\driverinstaller.exe
 - Connect the starter kit to CN4 (USB) with your PC
 - Open the PC software <drive:>\sw-examples\testsoftware\SK-FM4-U120-9B560_demo.exe
 - The picture of the board will be shown with current status of on-board features
 - LED allows control of the RGB-LED
 - ✓ Just click to the checkboxes
 - Status of user-buttons SW2 and SW3 are shown interactively
 - ADC represents the potentiometer R11

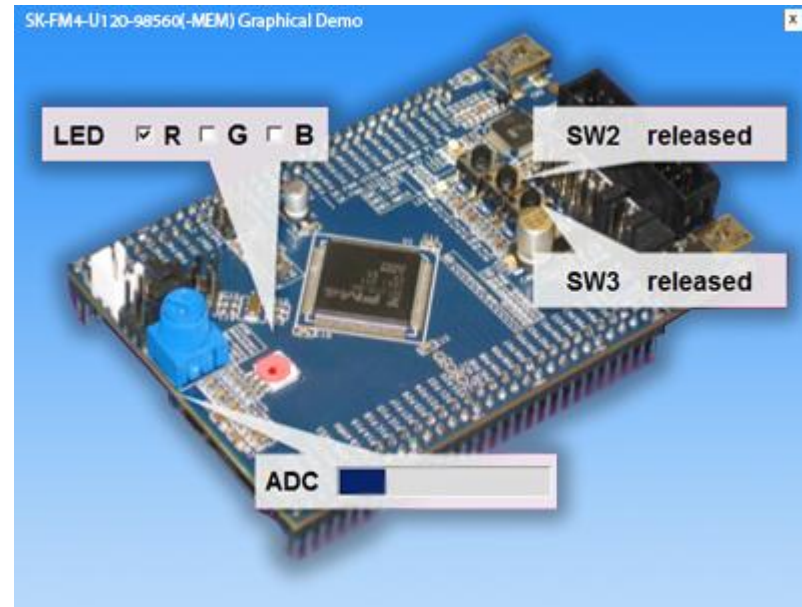

- You finished successfully the first test

Congratulation!

- Next section covers:
 - The on-board features
 - How to program the Flash
 - ✓ Serial ROM Boot loader
 - USB Direct
 - UART0
 - ✓ On-board CMSIS-DAP
 - ✓ JTAG with optional emulator
 - How to start with IAR-Embedded-Workbench and KEIL μ Vision



Hardware

The Hardware (Top Side) – Jumper Overview

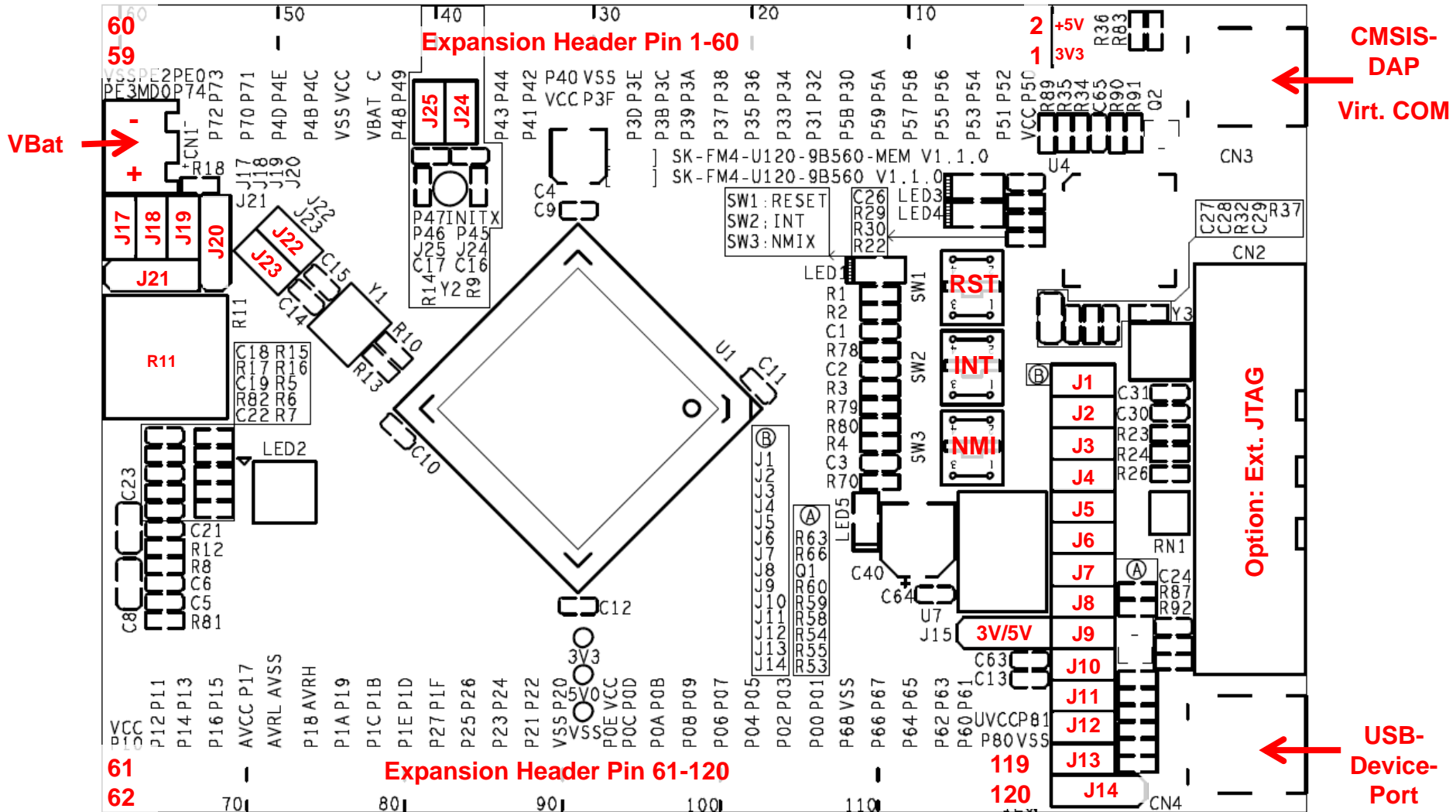

The Hardware (Bottom Side)

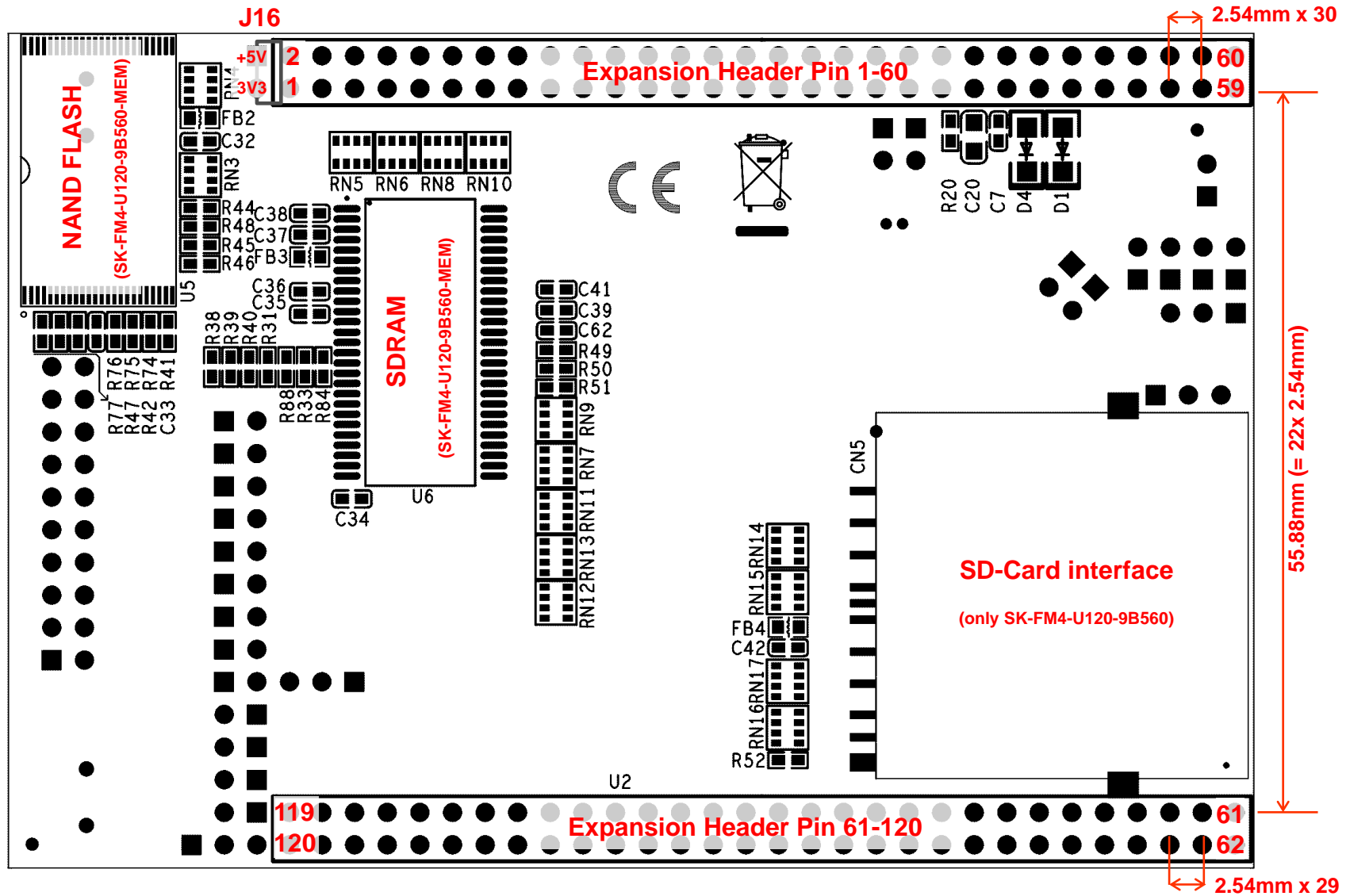

The Hardware – Pin Overview 1 - 20



Pin	Microcontroller-Function	SK-FM4-U120-9B560	SK-FM4-U120-9B560-MEM
1	VCC	VCC_MCU 3V3 or 5V0	VCC_MCU 3V3 or 5V0
2	P50/CTS4_0/AIN0_2/RTO10_0/INT00_0/MADATA00_0		SDRAM, NAND FLASH
3	P51/RTS4_0/BIN0_2/RTO11_0/INT01_0/MADATA01_0		SDRAM, NAND FLASH
4	P52/SCK4_0/ZIN0_2/RTO12_0/MADATA02_0		SDRAM, NAND FLASH
5	P53/TIOA1_2/SOT4_0/RTO13_0/MADATA03_0		SDRAM, NAND FLASH
6	P54/TIOB1_2/SIN4_0/RTO14_0/INT02_0/MADATA04_0		SDRAM, NAND FLASH
7	P55/ADTG_1/SIN6_0/RTO15_0/INT07_2/MADATA05_0		SDRAM, NAND FLASH
8	P56/SOT6_0/DTTI1X_0/INT08_2/MADATA06_0		SDRAM, NAND FLASH
9	P57/SCK6_0/MADATA07_0		SDRAM, NAND FLASH
10	P58/SIN4_2/AIN1_0/INT04_2/MADATA08_0		SDRAM
11	P59/RX1_1/SOT4_2/BIN1_0/INT07_1/MADATA09_0		SDRAM
12	P5A/TX1_1/SCK4_2/ZIN1_0/MADATA10_0		SDRAM
13	P5B/CTS4_2/MADATA11_0		SDRAM
14	P30/TIOB0_1/RTS4_2/INT15_2/WKUP1/MADATA12_0		SDRAM
15	P31/TIOB1_1/SIN3_1/INT09_2/MADATA13_0		SDRAM
16	P32/TIOB2_1/SOT3_1/INT10_1/MADATA14_0		SDRAM
17	P33/ADTG_6/TIOB3_1/SCK3_1/INT04_0/MADATA15_0		SDRAM
18	P34/TX0_1/TIOB4_1/FRCK0_0/MNALE_0		NAND FLASH
19	P35/RX0_1/TIOB5_1/IC03_0/INT08_1/MNCLE_0		NAND FLASH
20	P36/SIN5_2/IC02_0/INT09_1/MNWEX_0		NAND FLASH

The Hardware – Pin Overview 21 - 40



Pin	Microcontroller-Function	SK-FM4-U120-9B560	SK-FM4-U120-9B560-MEM
21	P37/SOT5_2/IC01_0/INT05_2/MNREX_0		NAND FLASH
22	P38/SCK5_2/IC00_0/INT06_2	LED_G	LED_G
23	P39/ADTG_2/DTTI0X_0/RTCCO_2/SUBOUT_2/MSDCLK_0		SDRAM
24	P3A/TIOA0_1/AIN0_0/RTO00_0/MSDCKE_0		SDRAM
25	P3B/TIOA1_1/BIN0_0/RTO01_0/MRASX_0		SDRAM
26	P3C/TIOA2_1/ZIN0_0/RTO02_0/MCASX_0		SDRAM
27	P3D/TIOA3_1/RTO03_0/MAD00_0		SDRAM
28	P3E/TIOA4_1/RTO04_0/MAD01_0		SDRAM
29	P3F/TIOA5_1/RTO05_0/MAD02_0		SDRAM
30	VSS	GND	GND
31	VCC	VCC_MCU 3V3 or 5V0	VCC_MCU 3V3 or 5V0
32	P40/TIOA0_0/RTO10_1/INT12_1		
33	P41/TIOA1_0/RTO11_1/INT13_1		
34	P42/TIOA2_0/RTO12_1/MSDWEX_0		SDRAM
35	P43/ADTG_7/TIOA3_0/RTO13_1/MCSX8_0		SDRAM
36	P44/TIOA4_0/RTO14_1/DA0		
37	P45/TIOB0_0/RTO15_1/DA1		
38	INITX	Button Reset / JTAG	Button Reset / JTAG
39	P46/X0A	Sub-Crystal 32.768 kHz	Sub-Crystal 32.768 kHz
40	P47/X1A	Sub-Crystal 32.768 kHz	Sub-Crystal 32.768 kHz

The Hardware – Pin Overview 41 - 60



Pin	Microcontroller-Function	SK-FM4-U120-9B560	SK-FM4-U120-9B560-MEM
41	P48/VREGCTL		
42	P49/VWAKEUP	Pull-Down resistor	Pull-Down resistor
43	VBAT	Battery (CN1)	Battery (CN1)
44	C	Capacitor 4u7	Capacitor 4u7
45	VSS	GND	GND
46	VCC	VCC_MCU 3V3 or 5V0	VCC_MCU 3V3 or 5V0
47	P4B/TIOB1_0/SCS7_1/MAD03_0		SDRAM
48	P4C/TIOB2_0/SCK7_1/AIN1_2/MAD04_0		SDRAM
49	P4D/TIOB3_0/SOT7_1/BIN1_2/INT13_2/MAD05_0		SDRAM
50	P4E/TIOB4_0/SIN7_1/ZIN1_2/FRCK1_1/INT11_1/WKUP2/MAD06_0		SDRAM
51	P70/TX0_0/TIOA4_2/AIN0_1/IC13_1		
52	P71/RX0_0/TIOB4_2/BIN0_1/IC12_1/INT15_1		
53	P72/TIOA6_0/SIN2_0/ZIN0_1/IC11_1/INT14_2		
54	P73/TIOB6_0/SOT2_0/IC10_1/INT03_2	USB	USB
55	P74/SCK2_0/DTT11X_1		
56	PE0/MD1	LED_B / MD1	LED_B / MD1
57	MD0	MD0	MD0
58	PE2/X0	Main-Crystal 4 MHz	Main-Crystal 4 MHz
59	PE3/X1	Main-Crystal 4 MHz	Main-Crystal 4 MHz
60	VSS	GND	GND

The Hardware – Pin Overview 61 - 80



Pin	Microcontroller-Function	SK-FM4-U120-9B560	SK-FM4-U120-9B560-MEM
61	VCC	VCC_MCU 3V3 or 5V0	VCC_MCU 3V3 or 5V0
62	P10/AN00/RX1_2/SIN1_1/FRCK0_2/INT02_1/MAD07_0		SDRAM
63	P11/AN01/TX1_2/SOT1_1/IC00_2/MAD08_0		SDRAM
64	P12/AN02/SCK1_1/IC01_2/RTCCO_1/SUBOUT_1/MAD09_0		SDRAM
65	P13/AN03/SIN0_1/IC02_2/INT03_1/MAD10_0		SDRAM
66	P14/AN04/SOT0_1/IC03_2/MAD11_0		SDRAM
67	P15/AN05/SCK0_1/MAD12_0		
68	P16/AN06/SIN2_2/INT14_1/MAD13_0		
69	P17/AN07/SOT2_2/WKUP3/MAD14_0		SDRAM
70	AVCC	VCC_MCU	VCC_MCU
71	AVSS	GND	GND
72	AVRL	GND	GND
73	AVRH	VCC_MCU	VCC_MCU
74	P18/AN08/SCK2_2/MAD15_0		SDRAM
75	P19/AN09/SIN4_1/IC00_1/INT05_1/MAD16_0		
76	P1A/AN10/SOT4_1/IC01_1/MAD17_0		
77	P1B/AN11/SCK4_1/IC02_1/MAD18_0		
78	P1C/AN12/CTS4_1/IC03_1/MAD19_0		
79	P1D/AN13/RTS4_1/DTTI0X_1/MAD20_0		
80	P1E/AN14/ADTG_5/FRCK0_1/MAD21_0		

The Hardware – Pin Overview 81 - 100

Pin	Microcontroller-Function	SK-FM4-U120-9B560	SK-FM4-U120-9B560-MEM
81	P1F/ADTG_4/TIOB6_2/RTO05_1		
82	P27/TIOA6_2/RTO04_1/INT02_2	LED_R	LED_R
83	P26/TIOB5_0/SCK2_1/RTO03_1		
84	P25/TX1_0/TIOA5_0/SOT2_1/RTO02_1		
85	P24/RX1_0/SIN2_1/RTO01_1/INT01_2		
86	P23/AN15/TIOA7_1/SCK0_0/RTO00_1/MAD22_0		
87	P22/CROUT_0/AN16/TIOB7_1/SOT0_0/ZIN1_1	JTAG	JTAG
88	P21/AN17/SIN0_0/BIN1_1/INT06_1/MAD23_0	JTAG	JTAG
89	P20/AN18/AIN1_1/INT05_0/MAD24_0	Potentiometer R11	Potentiometer R11
90	VSS	GND	GND
91	VCC	VCC_MCU 3V3 or 5V0	VCC_MCU 3V3 or 5V0
92	P0E/TIOB5_2/SCS6_1/IC13_0/S_CLK_0/MDQM1_0	SD-Card	SDRAM
93	P0D/TIOA5_2/SCK6_1/IC12_0/S_CMD_0/MDQM0_0	SD-Card	SDRAM
94	P0C/TIOA6_1/SOT6_1/IC11_0/S_DATA1_0/MALE_0	SD-Card	
95	P0B/TIOB6_1/SIN6_1/IC10_0/INT00_1/S_DATA0_0/MCSX0_0	SD-Card	NAND FLASH
96	P0A/SIN1_0/FRCK1_0/INT12_2/S_DATA3_0/MCSX1_0	SD-Card	
97	P09/AN19/TRACED0/TIOA3_2/SOT1_0/S_DATA2_0/MCSX5_0	SD-Card	
98	P08/AN20/TRACED1/TIOB3_2/SCK1_0/MCSX4_0		
99	P07/AN21/TRACED2/TIOA0_2/SCK7_0/MCLKOUT_0		
100	P06/AN22/TRACED3/TIOB0_2/SOT7_0/MCSX3_0		

The Hardware – Pin Overview 101 - 120



Pin	Microcontroller-Function	SK-FM4-U120-9B560	SK-FM4-U120-9B560-MEM
101	P05/AN23/ADTG_0/TRACECLK/SIN7_0/INT01_1/MCSX2_0		
102	P04/TDO/SWO	JTAG	JTAG
103	P03/TMS/SWDIO	JTAG	JTAG
104	P02/TDI/MCSX6_0	JTAG	JTAG
105	P01/TCK/SWCLK	JTAG	JTAG
106	P00/TRSTX/MCSX7_0	JTAG	JTAG
107	VSS	GND	GND
108	P68/TIOB7_2/SCK3_0/INT00_2	Button INT	Button INT
109	P67/TIOA7_2/SOT3_0		
110	P66/ADTG_8/SIN3_0/INT11_2		
111	P65/TIOB7_0/SCK5_1		
112	P64/TIOA7_0/SOT5_1/INT10_2		
113	P63/CROUT_1/RX0_2/SIN5_1/INT03_0/S_CD_0/MWEX_0	SD-Card	
114	P62/ADTG_3/TX0_2/SIN5_0/INT04_1/S_WP_0/MOEX_0	SD-Card	
115	P61/UHCONX0/TIOB2_2/SOT5_0/RTCCO_0/SUBOUT_0	USB	USB
116	P60/TIOA2_2/SCK5_0/NMIX/WKUP0/MRDY_0	Button NMIX	Button NMIX
117	USBVCC	3V3	3V3
118	P80/UDM0	USB	USB
119	P81/UDP0	USB	USB
120	VSS	GND	GND

Jumper table

Jumper	Function	SK-FM4-U120-9B560(-MEM) (Default setting marked bold)
J1 (2 pin)	CMSIS-DAP Crystal (P22) (Do not change!)	Open: 4MHz Closed: 48MHz
J2 (2 pin)	VBUS detection of CMSIS-DAP	Open: 3V3 Closed: 5V (only for SK-FM4-U120-9B560)
J3 (2 pin)	CMSIS-DAP reset	Open: CMSIS-DAP normal operation Closed: CMSIS-DAP reset assert
J4 (2 pin)	Operation of MD1 (CMSIS-DAP)	Open: Run-Mode Closed: Test-Mode
J5 (2 pin)	Operation of MD0 (CMSIS-DAP)	Open: Run-Mode (CMSIS-DAP) Closed: Firmware update of CMSIS-DAP
J6-J9	Power Supply Source Please select just one power source!	J9: USB Host powered (CN4) J8: JTAG powered (CN2) J7: CMSIS-DAP powered (CN3) J6: Powered by SK-FM4-U-PERIPHERAL (J16)
J10 (2 pin)	SW3 NMI Jumper J10 needs to be opened for programming	Open: Button SW3 disconnected / Programming mode Closed: Button SW3 (NMI) is connected
J11 (2 pin)	USB D+	Open: USB is disconnected Closed: USB is connected
J12 (2 pin)	USB D-	Open: USB is disconnected Closed: USB is connected
J13 (2 pin)	VBUS detection	Open: 3V3 Closed: 5V (only for SK-FM4-U120-9B560)

Jumper table (continued)

Jumper	Function	SK-FM4-U120-9B560(-MEM) (Default setting marked bold)
J14 (3 pin)	USB VBUS detection See also J10	1-2: VBUS is connected to INT03_2 (Run-Mode) 2-3: VBUS is connected to NMIX (Programming Mode)
J15 (3 pin)	MCU voltage selection SK-FM4-U120-9B560-MEM can be used with 3V3 only	1-2: MCU is powered from 3V3 2-3: MCU is powered from 5V (not SK-FM4-U120-9B560-MEM)
J17 (2 pin)	Operation of MD1 (Do not change!)	Open: Run-Mode and Programming-Mode Closed: Test-Mode
J18 (2 pin)	Operation of MD0	Open: Run-Mode Closed: Programming-Mode
J19 (2 pin)	CMSIS-DAP Virtual COM port (SIN0_0)	Open: SIN0 is disconnected from CMSIS-DAP Closed: CMSIS-DAP's virtual COM port is connected
J20 (3 pin)	CMSIS-DAP Virtual COM port (SOT0_0)	2-3: SOT0/P22 is used for USB programming 1-2: CMSIS-DAP's virtual COM port is connected
J21 (3 pin)	MD1/PE0 See also J17	1-2: MD1 (Programming-Mode) 2-3: PE0 (LED Blue)
J22 (2 pin)	X0/PE2 Do not close J22 if crystal Y1 is assembled.	Open: PE2 is disconnected Closed: PE2 is connected to pin header U2
J23 (2 pin)	X1/PE3 Do not close J23 if crystal Y1 is assembled.	Open: PE3 is disconnected Closed: PE3 is connected to pin header U2
J24 (2 pin)	X0A/P46 Do not close J24 if crystal Y2 is assembled.	Open: P46 is disconnected Closed: PE2 is connected to pin header U2
J25 (2 pin)	X1A/P47 Do not close J25 if crystal Y2 is assembled.	Open: P47 is disconnected Closed: PE2 is connected to pin header U2

Jumper – Programming Mode (USB Direct mode)

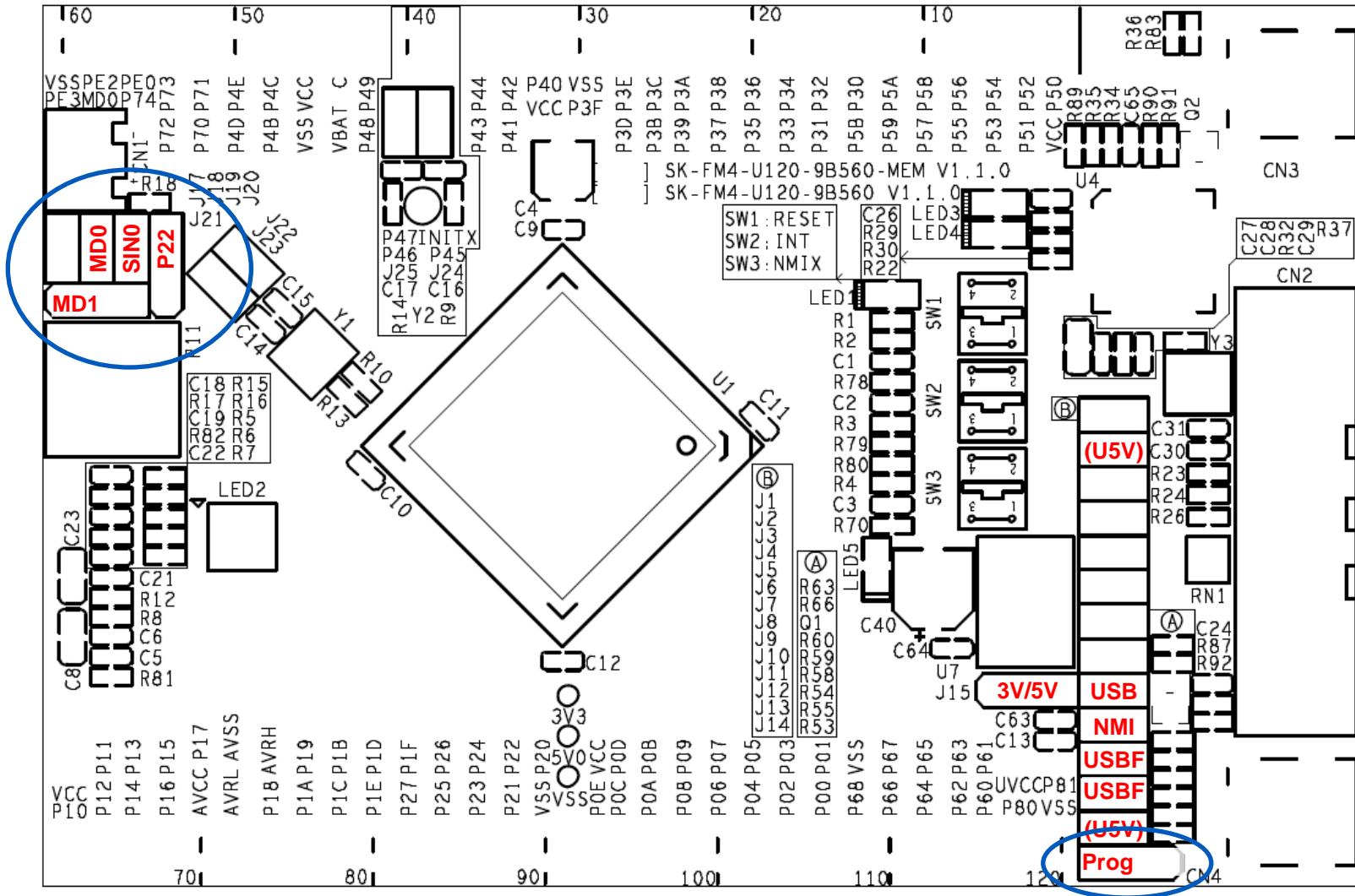

Jumper – Power the Starter kit

- The starter kit can be powered
 - by peripheral base-board (J16): Close jumper J6
 - by CMSIS-DAP (CN3): Close jumper J7 (default)
 - by external JTAG (CN2): Close jumper J8
 - by USB-host (CN4): Close jumper J9

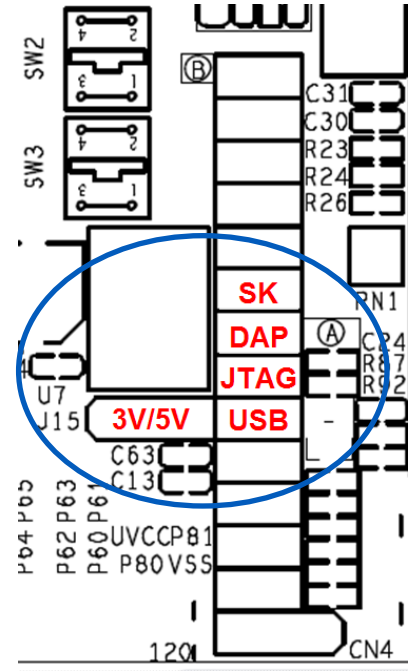

- 3.3V or 5V
 - Jumper J15 selects the target voltage
 - ✓ SK-FM4-U120-9B560 can operate 3.3V or 5V
 - ✓ SK-FM4-U120-9B560-MEM can operate 3.3V only
 - Default: J15: 1-2 (3.3V)

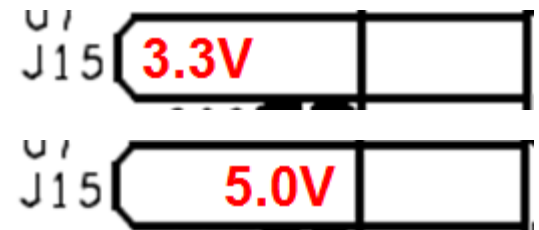



Software

- Simple example that demonstrates the usage of some peripherals

- Available for IAR EWARM or KEIL μ Vision:

See <drive:>[\sw-examples\](#) or www.cypress.com

- [mb9bf56xr_template](#)

- ✓ ,Empty' project as base for user applications

- [mb9bf56xr_adc_dvm](#)

- ✓ Digital Voltage Meter based on the A/D-Converter and UART

- [mb9bf56xr_gpio](#)

- ✓ I/O example to control LEDs and readout the user buttons

- [mb9bf56xr_mfs](#)

- ✓ An UART example allows serial communication

- Example projects that are built with PDL (Peripheral Driver Library)
 - Available for IAR EWARM or KEIL μ Vision:
See <drive:>[\sw-examples\](#) or www.cypress.com
 - [mb9bf56xr_pdl](#)
 - ✓ The Peripheral Driver Library (PDL) includes an API for all peripherals
 - mb9bf56xr_pdl_adc_dvm : Example for ADC
 - mb9bf56xr_pdl_gpio : Example for simple IO access
 - mb9bf56xr_pdl_mfs : Example for serial communication (UART)
 - mb9bf56xr_pdl_template : Project frame for user applications based on PDL
- Functional test
 - [tp_sk-fm4-u120-9b560](#)
 - ✓ Program for [Please check the jumper setting](#) the board features (LEDs, buttons, ADC, USB, ...)

- The following software utility tools are available
 - USB Virtual-COM port
 - ✓ allows UART communication via the PC's USB connection
 - ✓ On-board UART-2-USB converter (via CN3, CMSIS-DAP)
 - ✓ For driver installation <drive:>[\drivers\driverinstaller.exe](#)
 - FLASH USB DIRECT Programmer
 - ✓ Microcontroller Flash programming (via CN4, USB-Device-Port)
 - ✓ Install from <drive:>[\tools\USBDIRECT\setup.exe](#)
 - Terminal program ,Serial Port Viewer'
 - ✓ Install from <drive:>[\tools\serialportviewer\setup.exe](#)



Flash Programming

- There are several options to program the microcontroller's flash:
 - FLASH USB DIRECT Programmer via CN4 (USB)
 - ✓ For installation <drive:>[\tools\USBDIRECT\setup.exe](#)
 - ✓ USB driver is located in subdirectory of FLASH USB DIRECT Programmer
 - FLASH MCU Programmer via CN3 (Serial by use of virtual COM-port)
 - ✓ For installation <drive:>[\tools\PCWFM\setup.exe](#)
 - ✓ For driver installation of USB/Virtual-COM port <drive:>[\drivers\driverinstaller.exe](#)
 - JTAG Programming via CN3 (CMSIS-DAP)
 - ✓ Example is given for [IAR](#) and [KEIL](#)
 - ✓ See documentation of your development suite, how to setup CMSIS-DAP
 - JTAG Programming via CN2 (optional JTAG adapter)
 - ✓ The correct JTAG-adapter must be selected in the IDE toolchain
 - ✓ No dedicated jumper setting is required

- FLASH USB DIRECT Programming via CN4 (USB)
 - Jumper Setting
 - ✓ Close J9 (Power:USB), J11 (USB D+), J12 (USB D-) and J18 (MD0)
 - ✓ Set J14 to position 2-3 (P60, USB_VCC_DETECT)
 - ✓ Set J20 to position 2-3 (P22)
 - ✓ Set J21 to position 1-2 (MD1)
 - ✓ For 5V operation set J15 to 2-3, close J2 and J13
 - ✓ For 3.3V operation set J15 to 1-2, open J2 and J13
 - Connect the board via USB-Device (CN4) to the USB-Port of the PC
 - ✓ If connected for first time Windows OS may ask for a driver
See subfolder ,driver' of USBdirect installation path
or <drive:>[\tools\USBDIRECT\driver](#)
 - Start the FLASH USB DIRECT Programmer
 - ✓ For first installation: <drive:>[\tools\USBDIRECT\setup.exe](#)

Flash Programming via CN4 (USB direct)

- Choose the right target MCU MB9BF568M/N/R
- Browse for the programming file (*.srec or *.hex)
 - IAR: see subfolder <project>\example\IAR\output\release\exe
 - ARM/KEIL: see subfolder <project>\example\ARM\output\release
- Adjust the corresponding virtual COM-port

Select MCU: MB9BF568M/N/R

Select file (*.srec; *.hex)

Select Virtual COM-port

- Use Full Operation

- Download
- Erase / Blank check
- Program & Verify
- Reset jumpers and return to [Run-mode](#) jumper setting

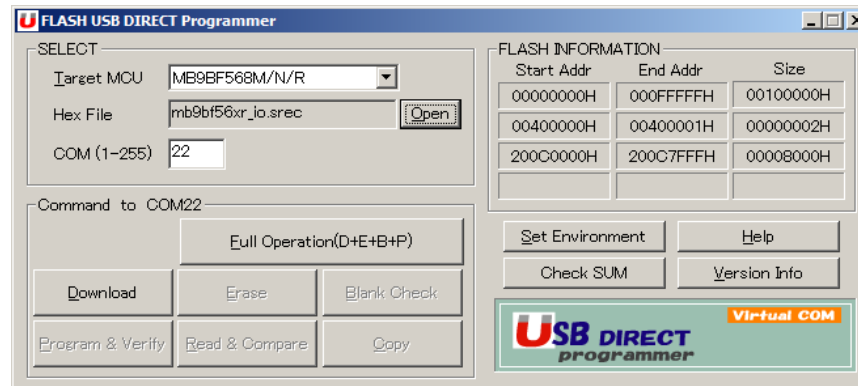

- FLASH MCU Programming via CN3 (Serial)*
 - Jumper setting
 - ✓ Open jumpers J3 (JTAG) and J10 (NMIX)
 - ✓ Close jumpers J7 (Power: DAP), J18 (MD0) and J19 (SIN0)
Do not set J9 (USB Host powered)!
 - ✓ Set J20 to position 1-2 (SOT0)
 - ✓ Set J21 to position 1-2 (MD1)
 - ✓ Check jumper setting: J14:2-3 (P60)
 - Connect the board via USB CMSIS-DAP (CN3) to the USB-Port of the PC
 - ✓ When connected for first time Windows OS may ask for
,spanionusbvcomm.inf'
<drive:>[\drivers\cmsis-dap](#)
 - Use the FLASH MCU Programmer for FM3/FM4
 - ✓ For installation <drive:>[\tools\PCWFM\setup.exe](#)
- *Note: Do not connect CN4 to PC/USB while using serial programming

Flash Programming via CN3 (Serial)

Jumper setting PRG-mode using CMSIS-DAP (serial communication)

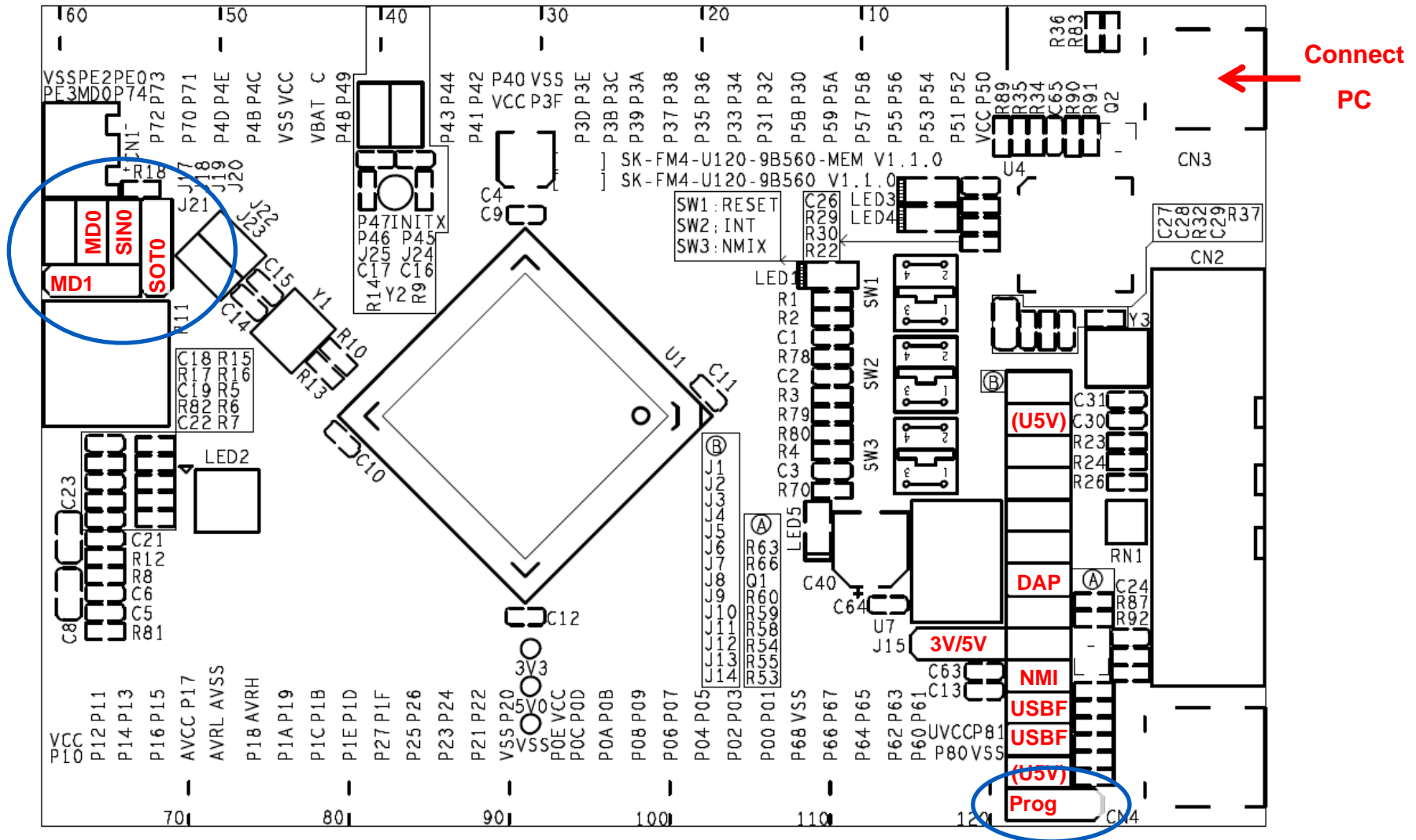

Flash Programming via CN3 (Serial)

- Choose the right target MCU MB9BF568M/N/R
- Select 4MHz Crystal Frequency
- Browse for the programming file (*.srec or *.hex)
 - IAR: see subfolder <project>\example\IAR\output\release\exe
 - ARM/KEIL: see subfolder <project>\example\ARM\output\release
- Adjust the corresponding virtual COM-port

Select MCU: MB9BF568M/N/R

Select 4MHz Crystal Frequency

Select file (*.srec / *.hex)

Select Virtual COM-port

Execute 'Full Operation'

incl. stand-alone operations

- Download

- Erase

- Blank Check

- Program&Verify

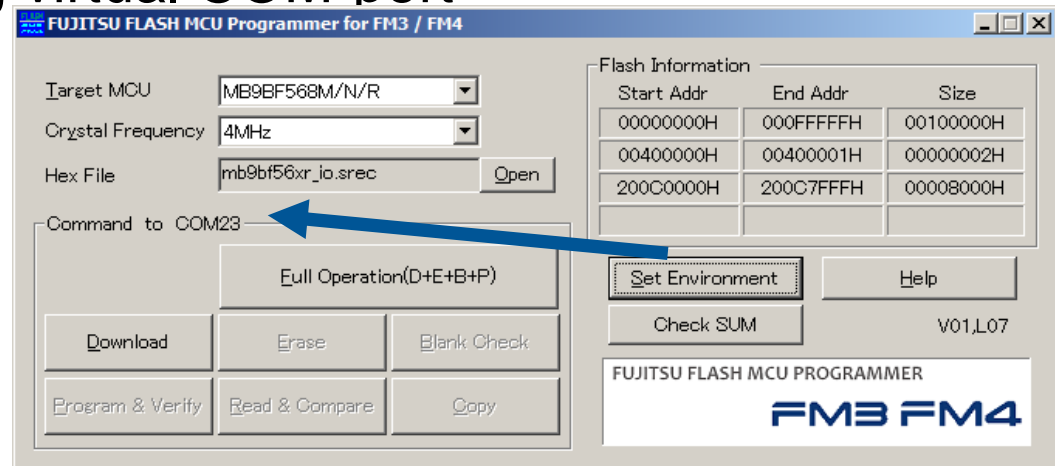

- Reset jumpers and return to Run-mode jumper setting

Flash Programming via CN3 (Serial)

Jumper setting RUN-mode using CMSIS-DAP (serial communication)

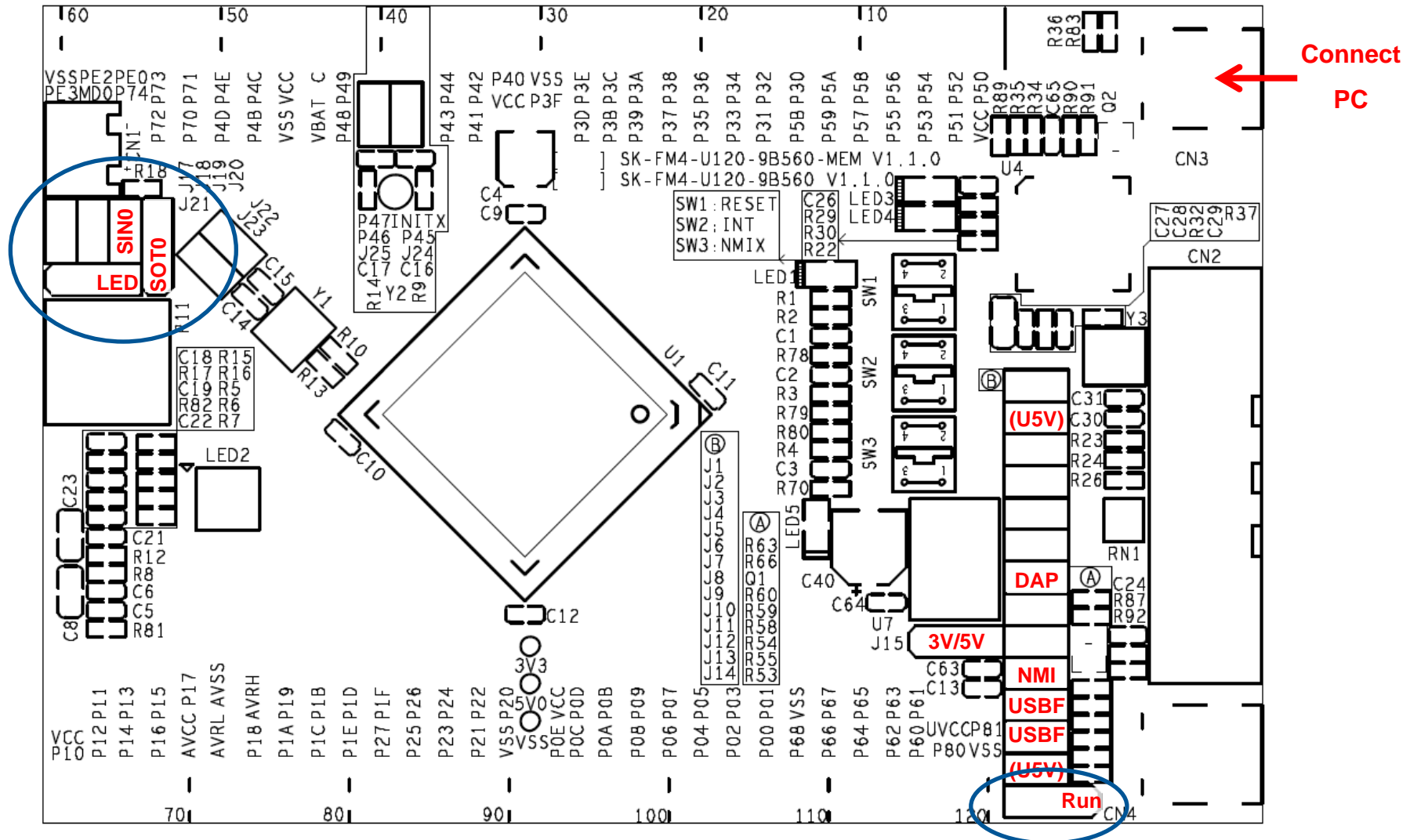



JTAG Debugger

JTAG adapter CMSIS-DAP

- This starter kit includes an on-board JTAG adapter
 - Compatible to CMSIS-DAP
 - http://www.keil.com/support/man/docs/dapdebug/dapdebug_introduction.htm
 - Please update the on-board CMSIS-DAP with [latest firmware](#)
 - Select debugger CMSIS-DAP in your tool chain
- Any other JTAG-adapter can be connected to CN2, too.
 - Select used JTAG-adapter within IDE tool chain (No jumper setting is required)
- Additional virtual COM port is provided by CN3
 - ✓ For driver installation <drive:>[\drivers\driverinstaller.exe](#)
 - ✓ Please set jumper J19 and J20 accordingly

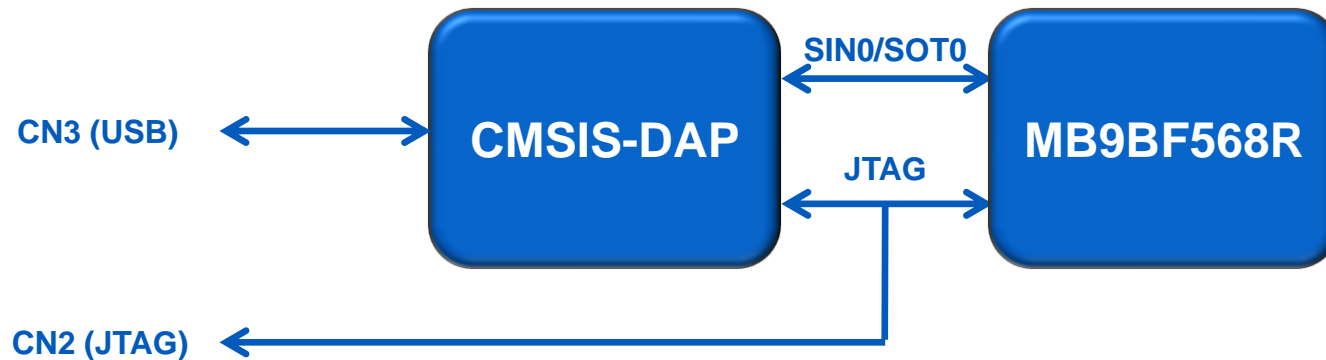

CMSIS-DAP Firmware update

Please see instructions coming with Firmware update package!

See <drive:>[tools\cmsisdap_fw_update](#)

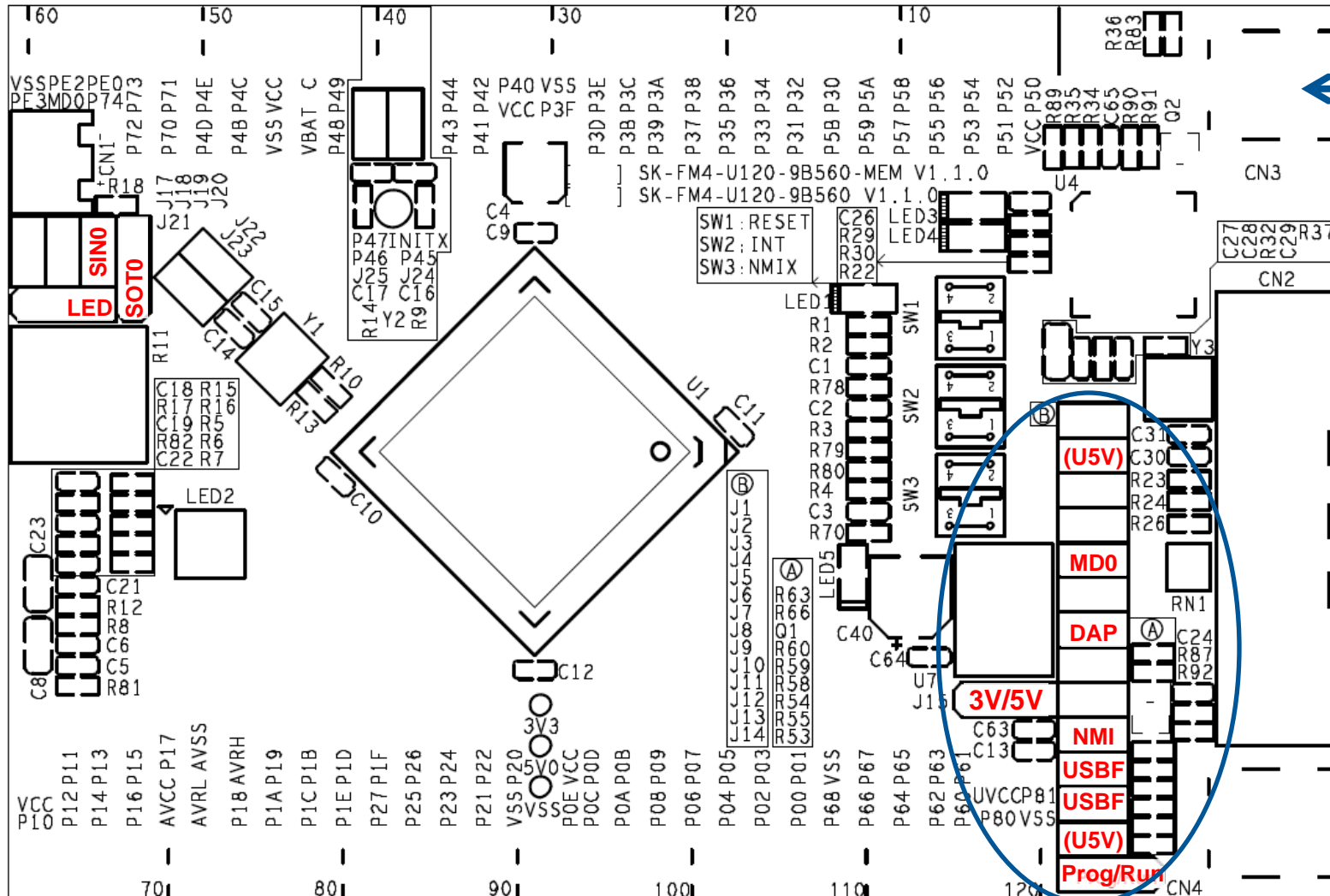

CMSIS-DAP
Virt. COM

Test it by terminal using CMSIS-DAP

- The microcontroller on the SK-FM4-U120-9B560(-MEM) is already preprogrammed with a test application (<drive:>\sw-examples\testsoftware)
 - Install the USB Driver first <drive:>\drivers\driverinstaller.exe
 - Connect the starter kit to CN3 (CMSIS-DAP) with your PC
 - ✓ Ensure jumper J7 (CMSIS-DAP) is set for correct power supply
 - Press the ,Reset'- Button
 - Check the availability for virtual COM port
 - ✓ e.g. Windows Device Manager
 - Open a serial terminal tool
 - ✓ e.g. Cypress Serial Port Viewer
 - <drive:>\tools\serialportviewer\setup.exe
 - ✓ Settings 115200 baud, 8N1
 - Press <space> to show welcome menu
 - Please select any function to test the on-board features

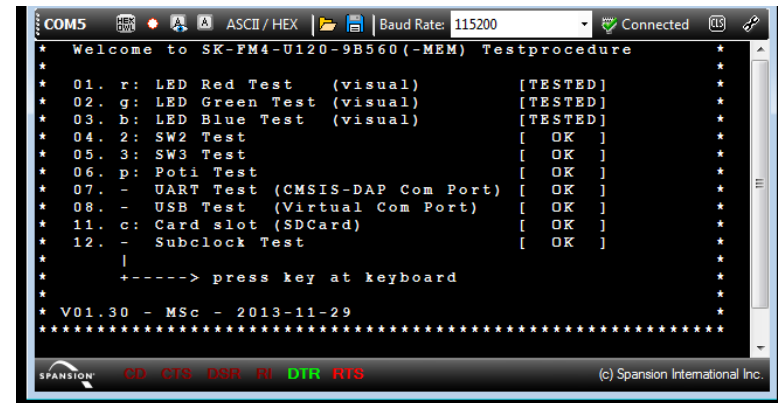
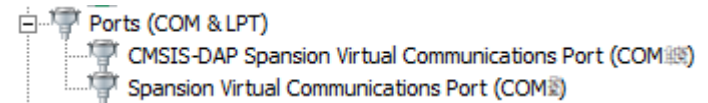

```
COM5  ASCII/HEX  Baud Rate: 115200  Connected  [E]  [R]
* Welcome to SK-FM4-U120-9B560 (-MEM) Testprocedure *
*
* 01. r: LED Red Test (visual) [TESTED] *
* 02. g: LED Green Test (visual) [TESTED] *
* 03. b: LED Blue Test (visual) [TESTED] *
* 04. 2: SW2 Test [ OK ] *
* 05. 3: SW3 Test [ OK ] *
* 06. p: Pot1 Test [ OK ] *
* 07. - UART Test (CMSIS-DAP Com Port) [ OK ] *
* 08. - USB Test (Virtual Com Port) [ OK ] *
* 11. c: Card slot (SDCard) [ OK ] *
* 12. - Subclock Test [ OK ] *
*
* |
* +-----> press key at keyboard *
*
* V01.30 - MSc - 2013-11-29
*****
SPANSION CD CTS DSR RI DTR RTS (c) Spansion International Inc.
```

JTAG adapter CMSIS-DAP – using IAR

Setup in IAR EWARM (1)

Navigate to project options:

Via Files-List

- Right-click at the project
- Select [Options...]

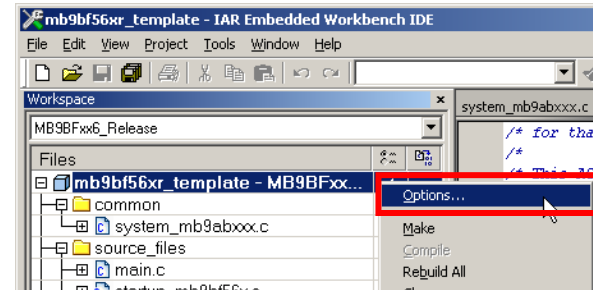

Or via menu tab [Project]

- Select [Options...]

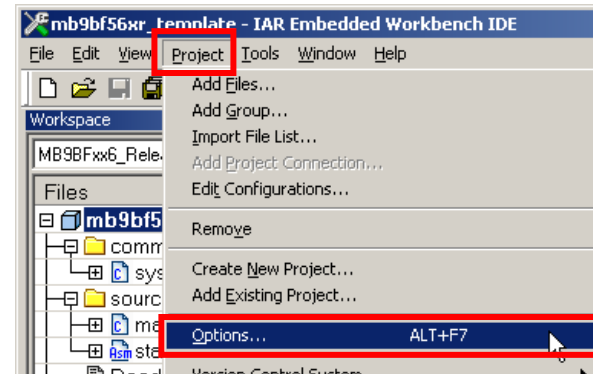

Setup in IAR EWARM (2)

Setup Project Debbuger Options

- (1) Navigate to [Debugger]
- (2) Select tab [Setup]
- (3) Select driver [CMSIS-DAP]
- (4) Select in [CMSIS-DAP]
- (5) Select tab [JTAG/SWD]
- (6) Select [SWD]

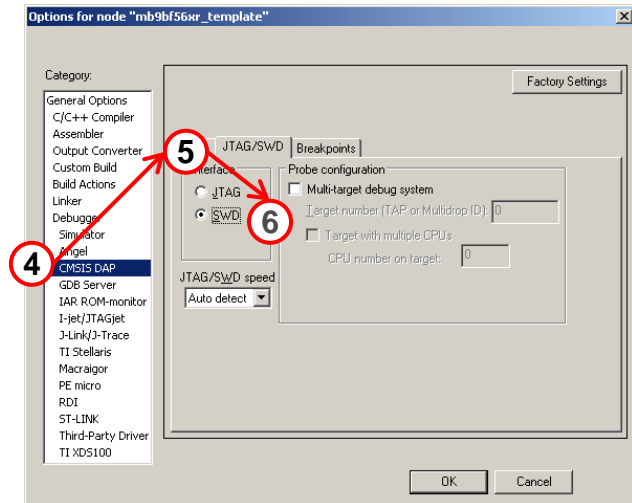
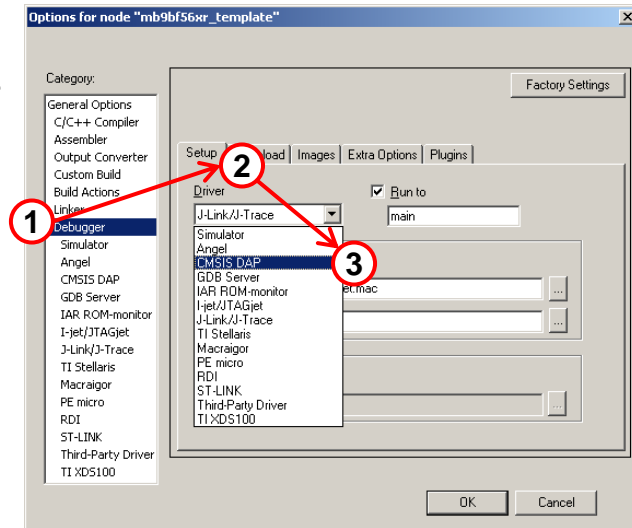

Setup in Keil μ Vision (1)

Navigate to project options:

Via Project

- Right-click at the project
- Select [Options...]

Or via menu tab [Project]

- Select [Options...]

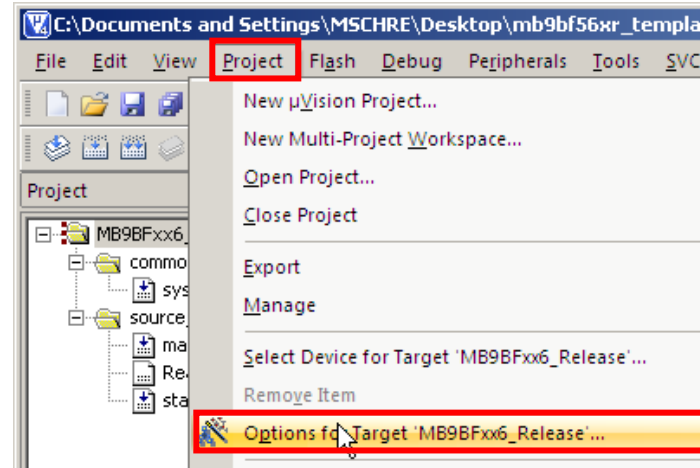
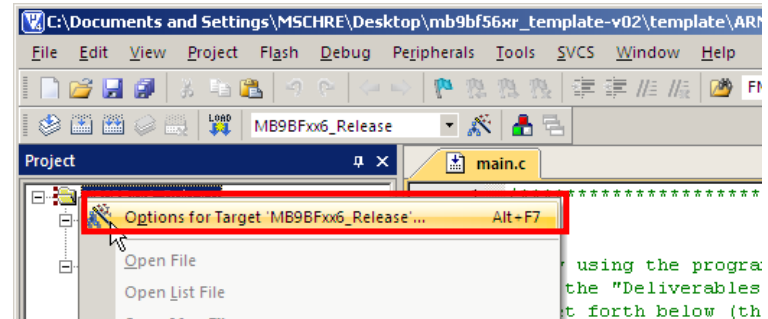

Setup in Keil μ Vision (2)

Setup Debug & Utilities

- (1) Select tab [Debug]
- (2) Select [CMSIS-DAP Debugger]
- (3) Select tab [Utilities]
- (4) Select [CMSIS-DAP Debugger]

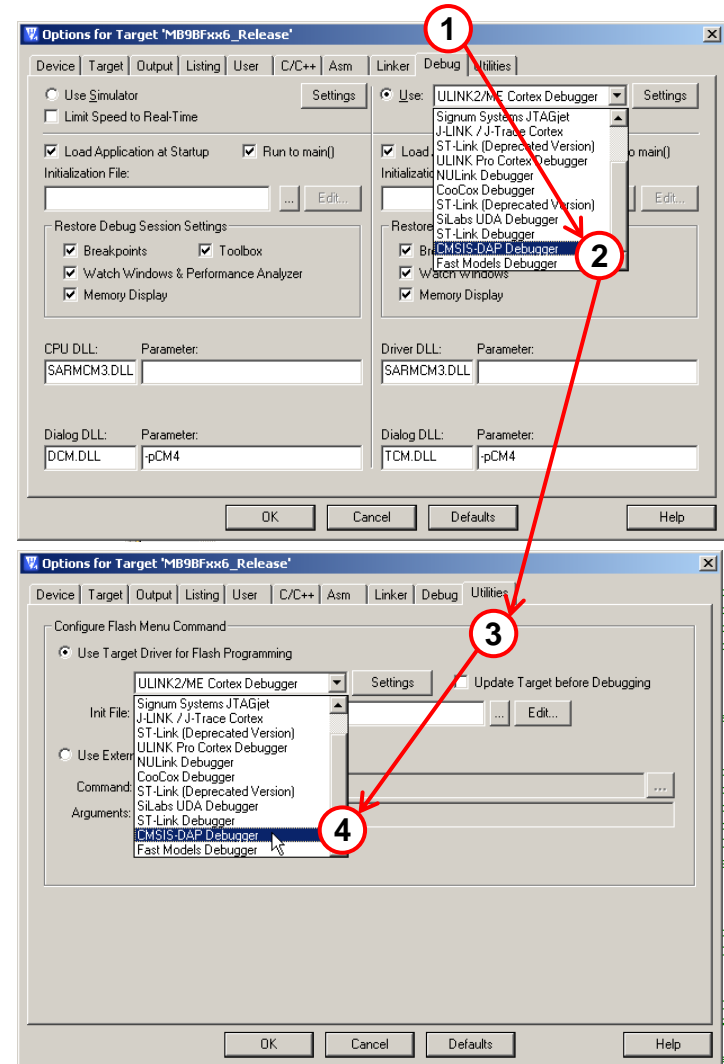

IAR Embedded Workbench

Installation
Getting Started
Open Project
Build Project
Debug Project

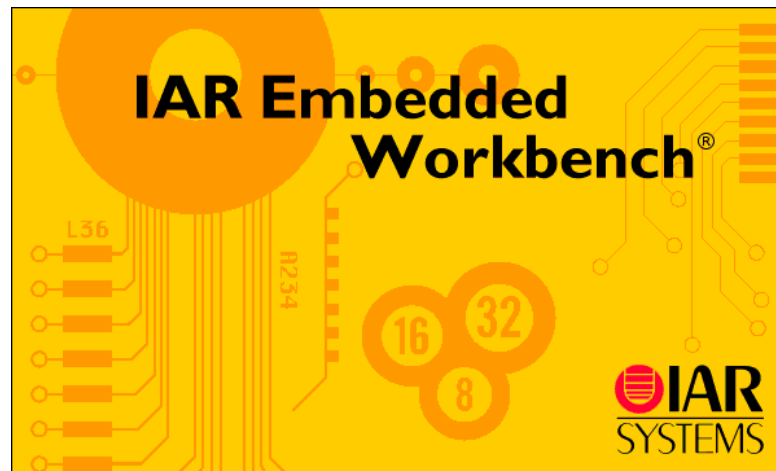

IAR Workbench Getting Started

- Install EWARM from IAR-CD or download latest version from IAR Website
 - EWARM size-limited (32k) or time-limited (full) Evaluation Version
 - ✓ <http://supp.iar.com/Download/SW/?item=EWARM-EVAL>
- Start EWARM Workbench
- Choose File → Open → Workspace
 - e.g.: <drive:>\sw-examples\mb9bf56xr_gpio-v11\example\IAR\mb9bf56xr_io.eww



IAR Workbench – Main Window

- IAR Workbench
 - Workspace on left side of Workbench window
 - ✓ If hidden then View → Workspace
 - Source files on right side of Workbench window as tabbed windows
 - Project open
File → Open → Workspace → *.eww
 - For new projects start with ,mb9bf56xr_template'

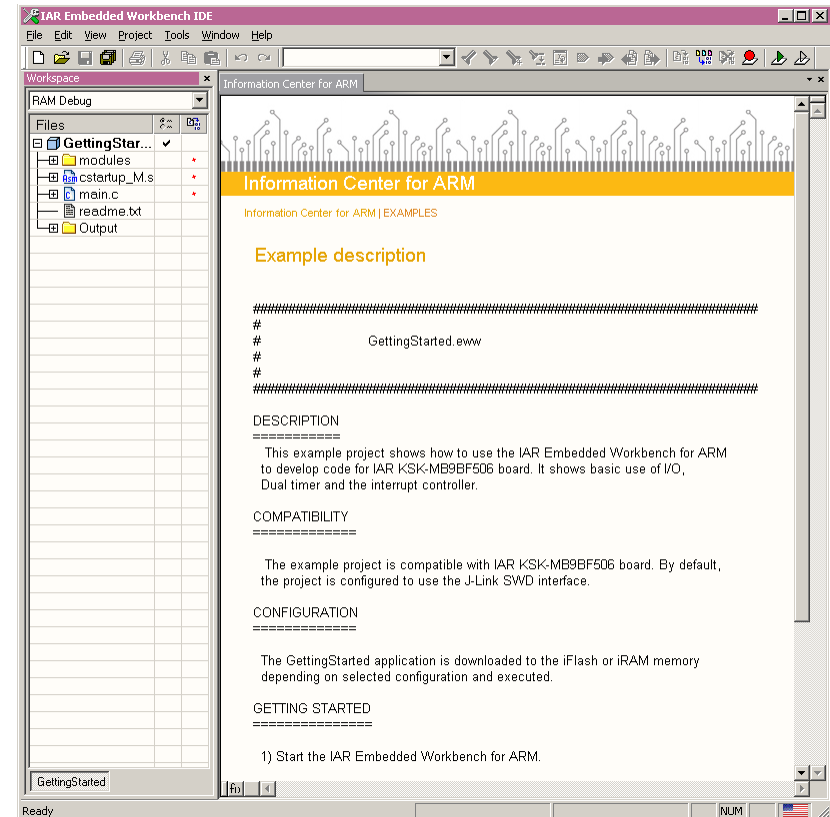

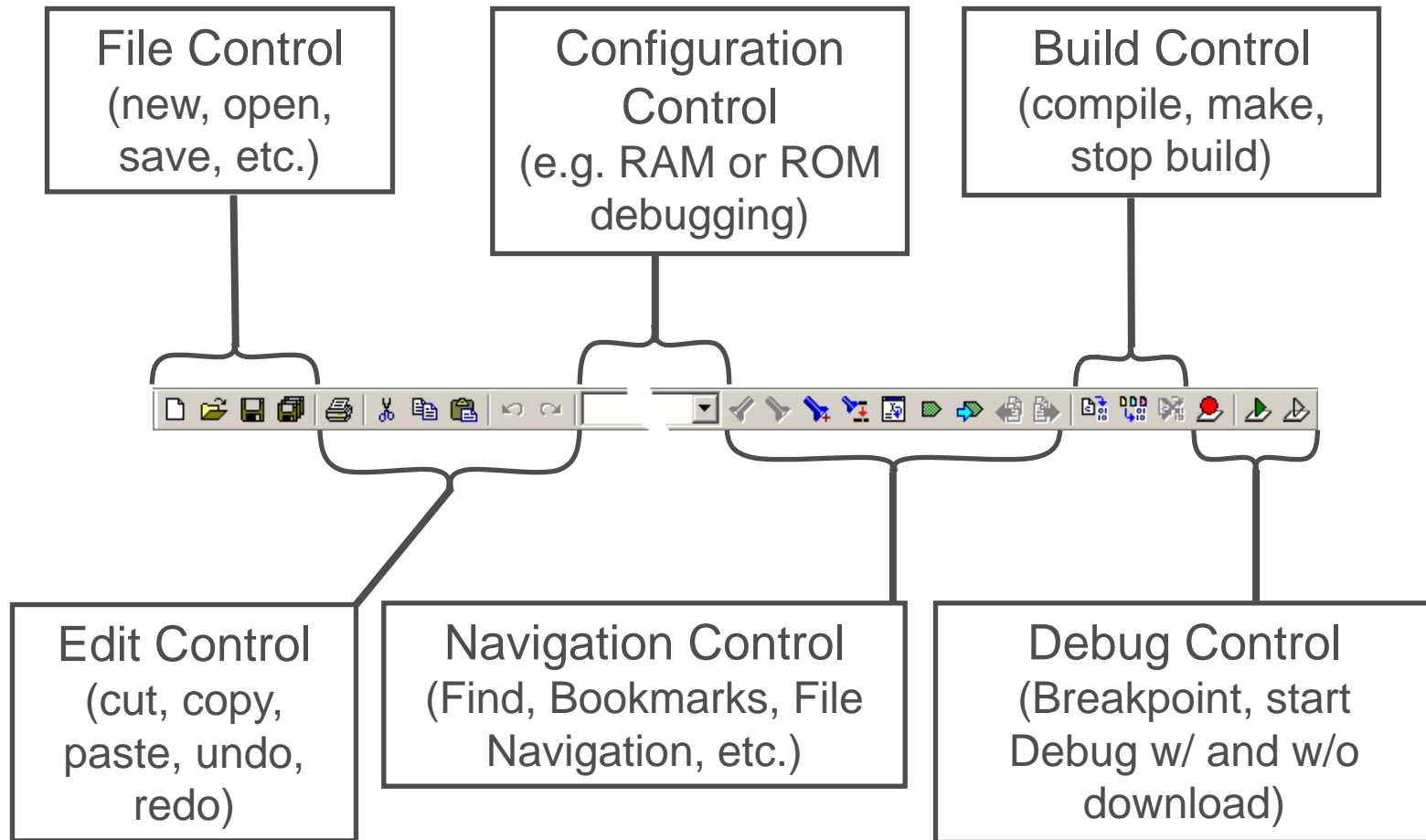

- IAR Menu Bar



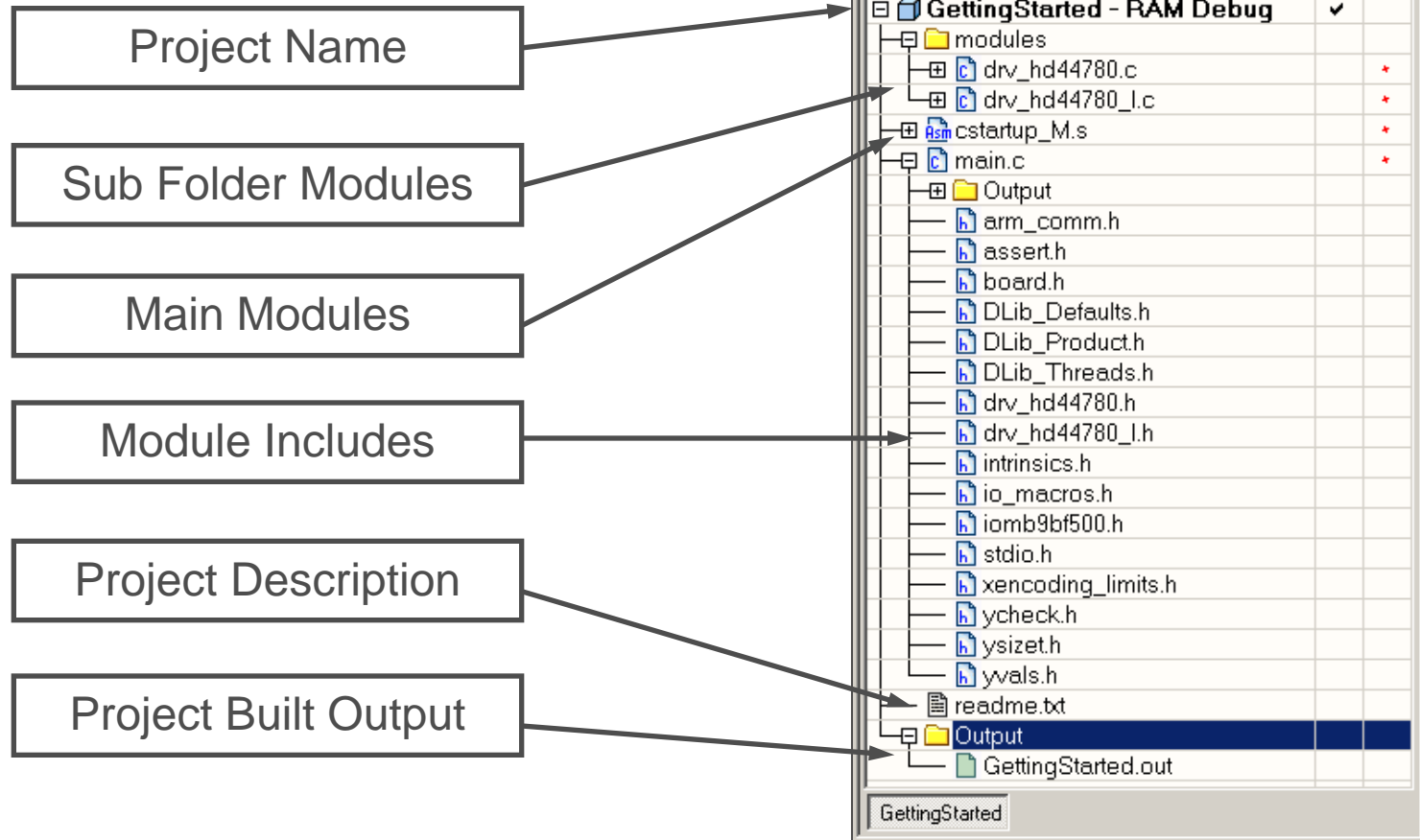

- IAR Workspace Window

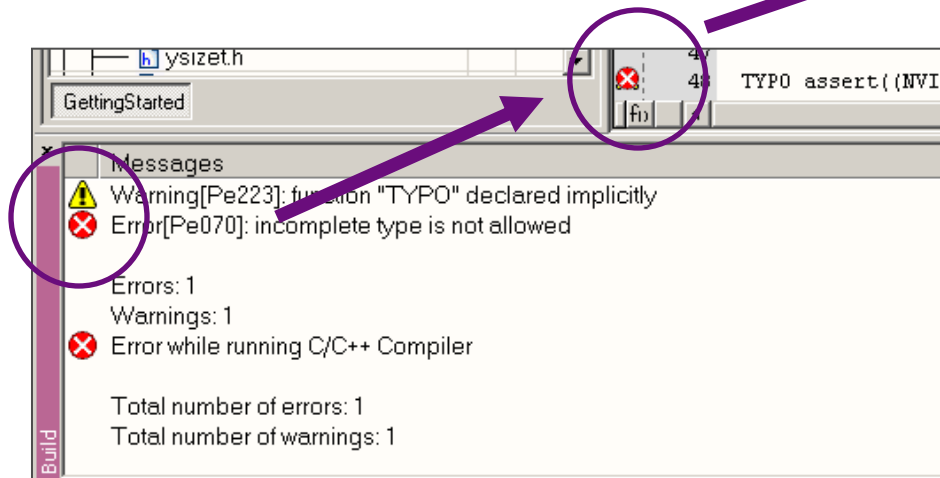
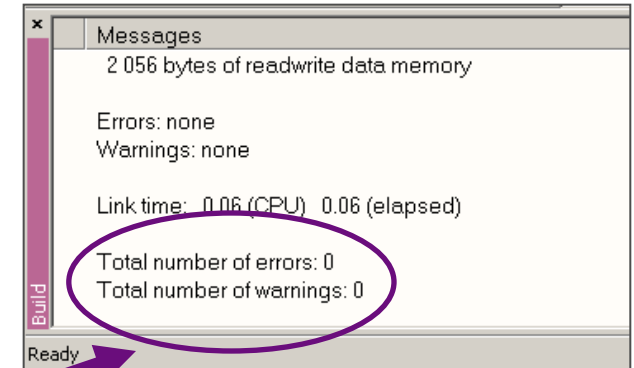

■ Making the Project

- Use Make-Icon (), <F7> or Menu: Project→Make
- Check for no errors in Output window below
- Build errors are indicated by  or 
In Output window and Source view



- Download to Target and Start Debugging
 - Use  icon, <Ctrl>-D, or Project→Download and Debug
 - A new menu bar will occur on successful connection to target

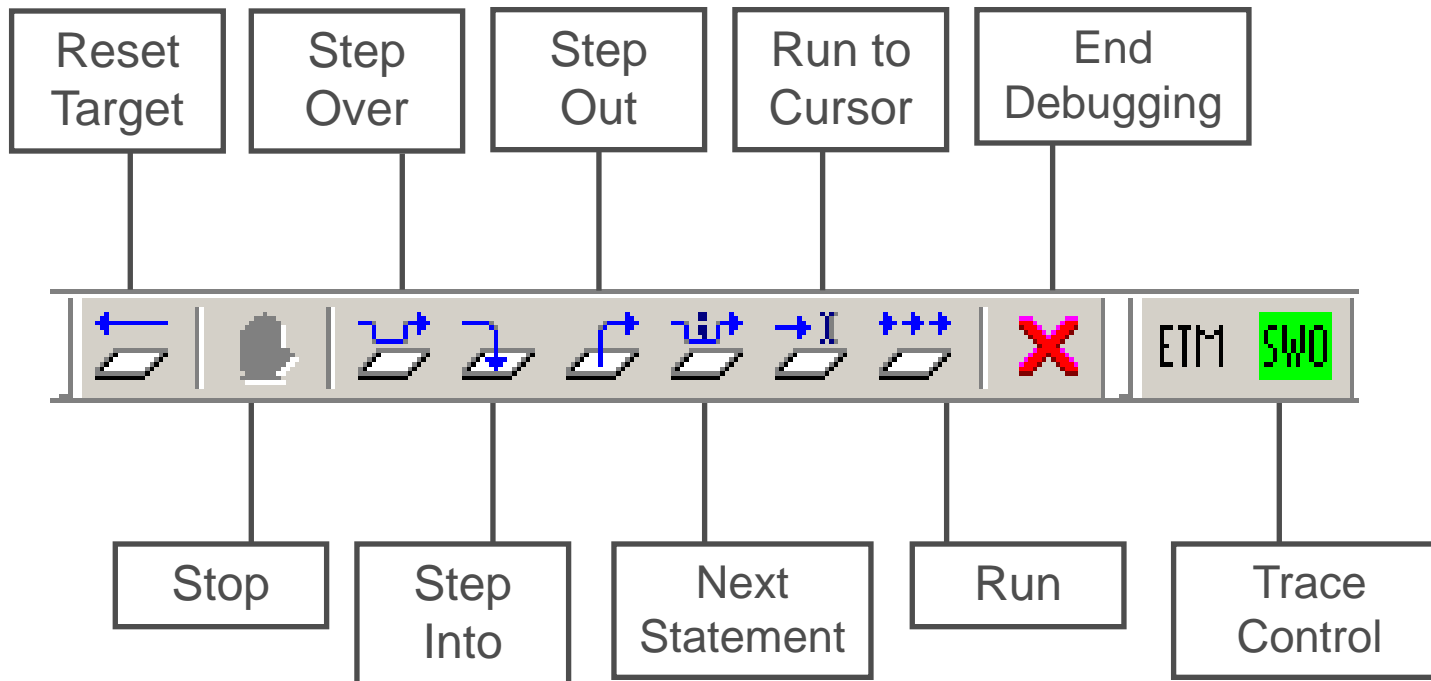

■ Source Window

- The Source windows do not change contents but get additional information

- ✓ Current line (PC):
- ✓ Halted on Breakpoint:
- ✓ Halted on Data break (example):

```
165 CSW_TMR_bit.MOWT = 9;  
172 PSW_TMR_bit.POWT = 2;  
148 Timer1IntClr = 1;
```

■ Disassembly Window

- Shows 'pure' disassembly view
- Shows mixed mode view

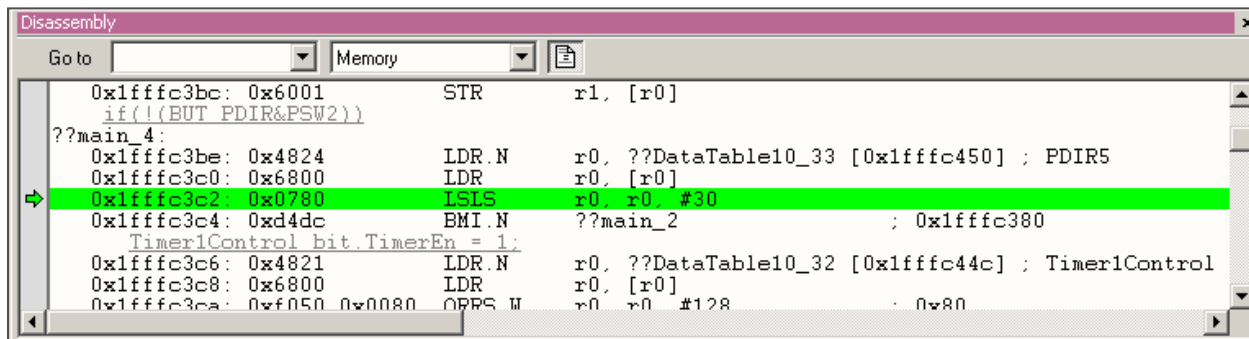

■ Watch Window

• Watch

- ✓ Expressions/Variables have to be added by user and are updated by Halt/Breakpoint

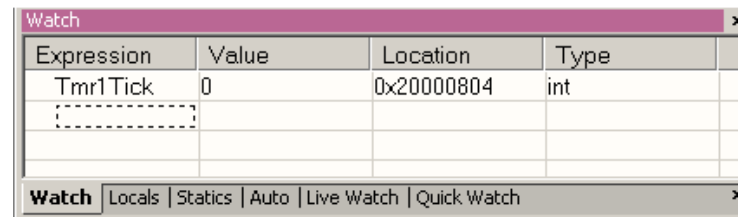

• Quick Watch

- ✓ The Quick watch allows the user to calculate and recalculate expressions even with variables

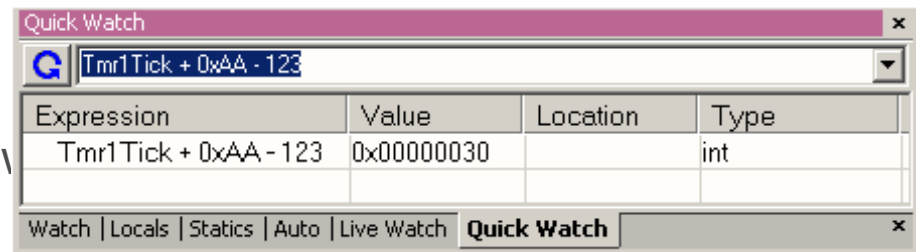

- ✓ The drop down

- Simulator
 - Mark Project File in Workspace
 - Choose Project→Options
 - Choose Simulator in Debugger Setup
 - Start Simulator with usual  Icon

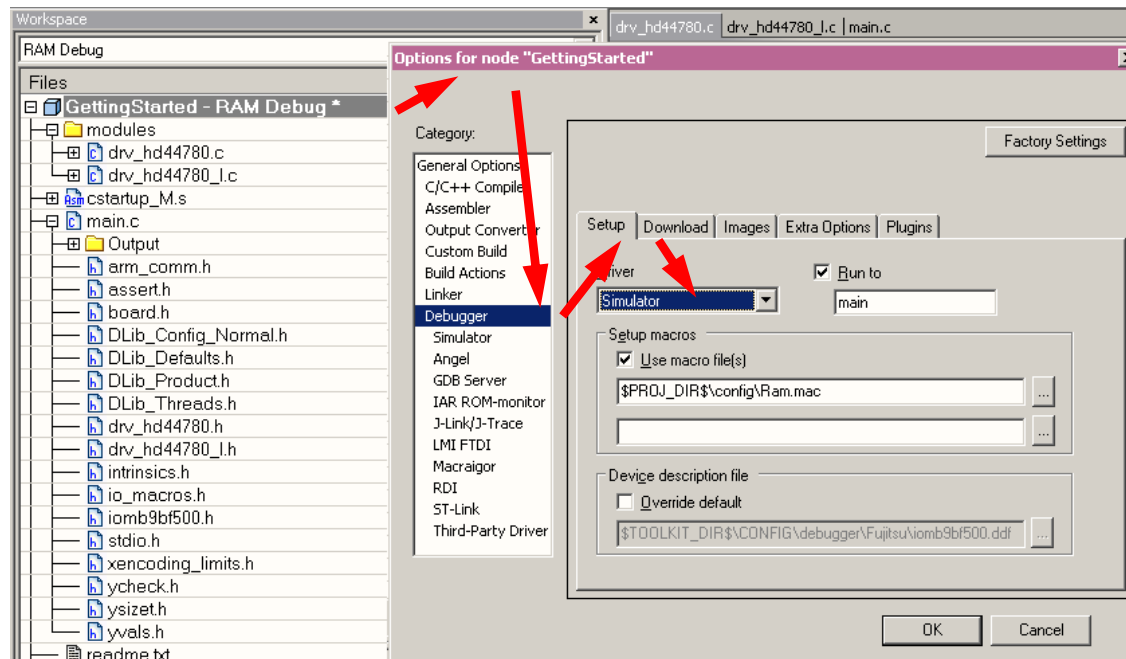

KEIL μ Vision

Installation
Getting Started
Open Project
Build Project
Debug Project



- Install μ Vision from KEIL-CD or download latest version from KEIL Website
 - Evaluation Version
 - ✓ <https://www.keil.com/demo/eval/arm.htm>
 - ✓ Registration required
- Install ULINK-ME
 - Special installation is not needed, because ULINK-ME acts as a USB Human Interface Device (HID) and thus needs no extra USB driver
- Install ULINK Pro (optional)
 - ULINK Pro needs an own dedicated USB driver located in:
<Installation Path>\KEIL\ARM\ULINK
- Start μ Vision

KEIL μ Vision – Getting Started

- Choose Menu: Project→Open Project...
 - Browse to: <drive:>\sw-examples\mb9bf56xr_gpio-v11\example\ARM\
 - Choose mb9bf56xr_gpio.uvproj

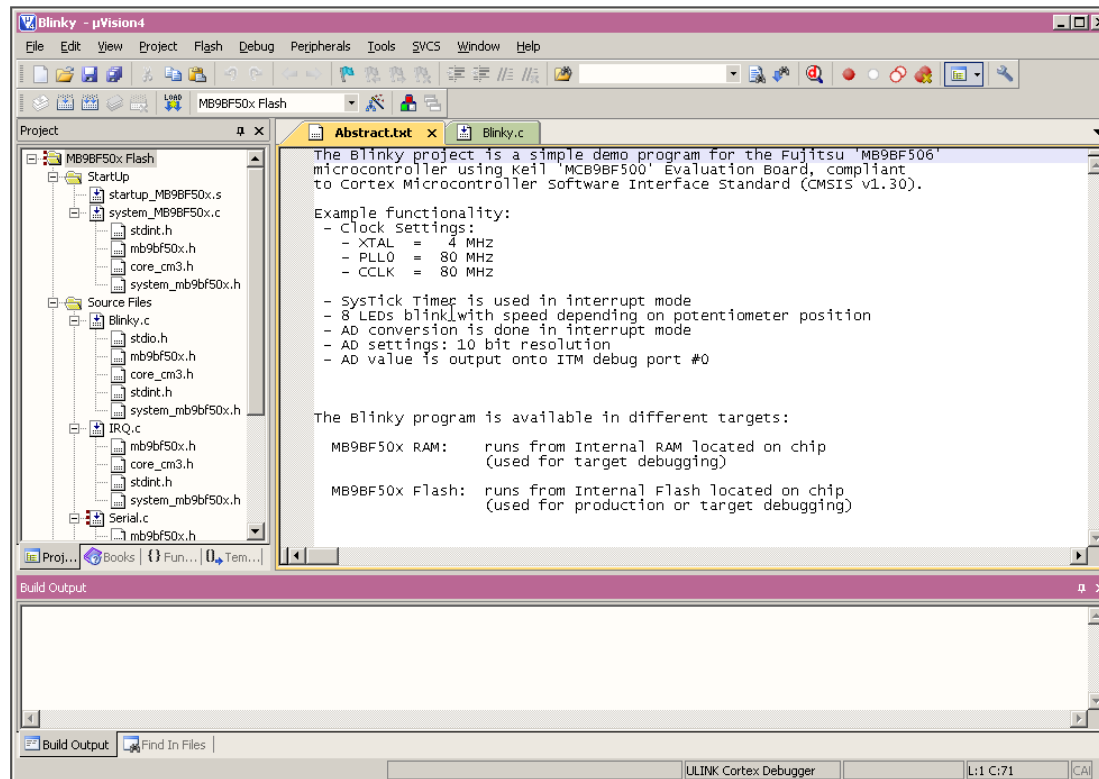

KEIL μ Vision – Main Window

- KEIL μ Vision
 - Project window on left side of IDE window
 - ✓ Choose:
View \rightarrow Project Window
if hidden
 - Source files on right side of IDE window as tabbed windows
 - Output window on bottom side of IDE window

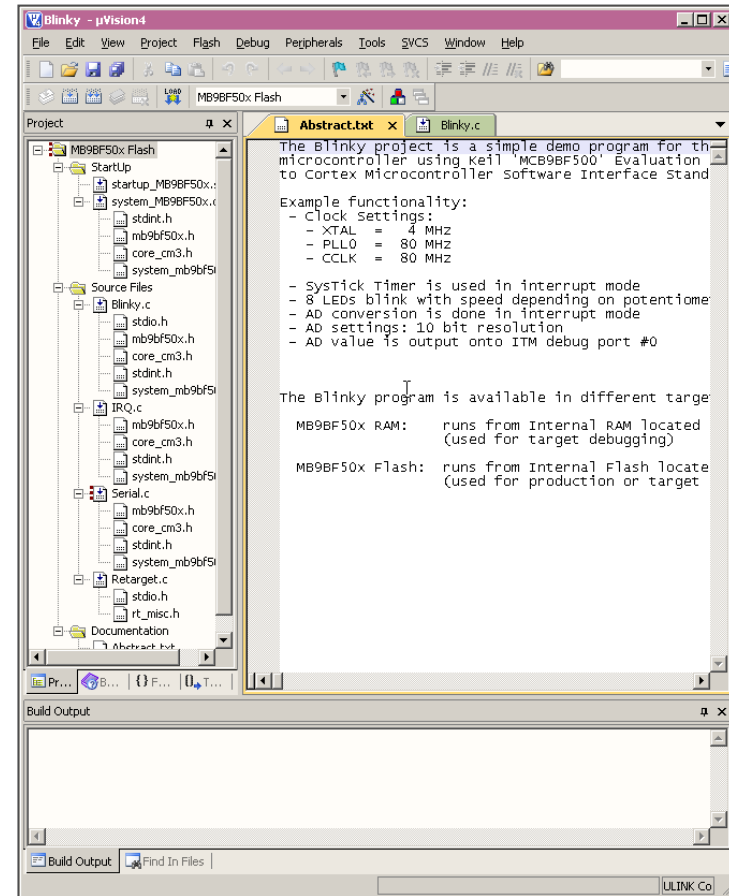

KEIL μ Vision – Menu Bars (1)

- Menu Bar 1
 - Can be moved in bar window area or set floating

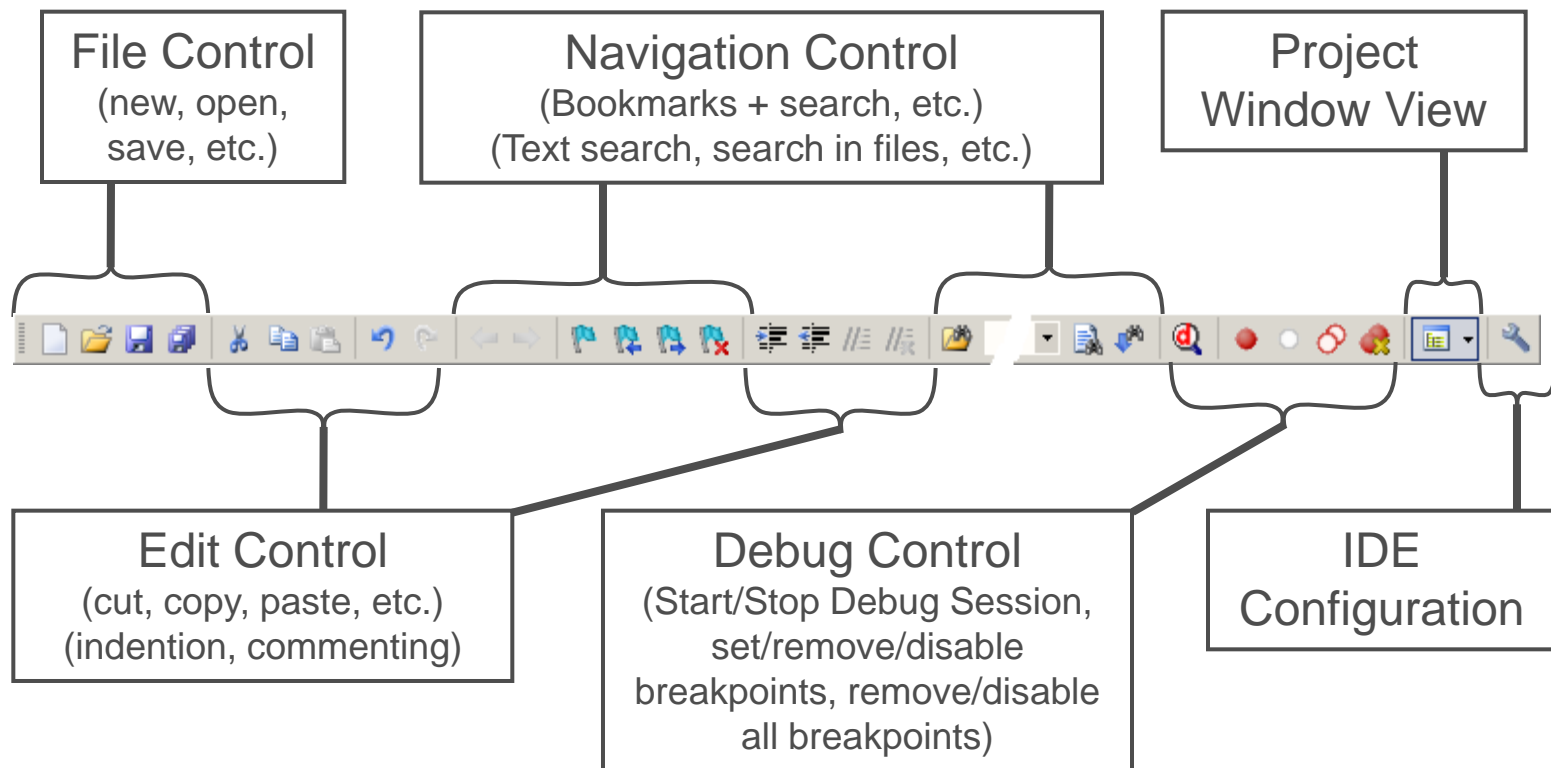

KEIL μ Vision – Menu Bars (2)

- Menu Bar 2
 - Can be moved in bar window area or set floating

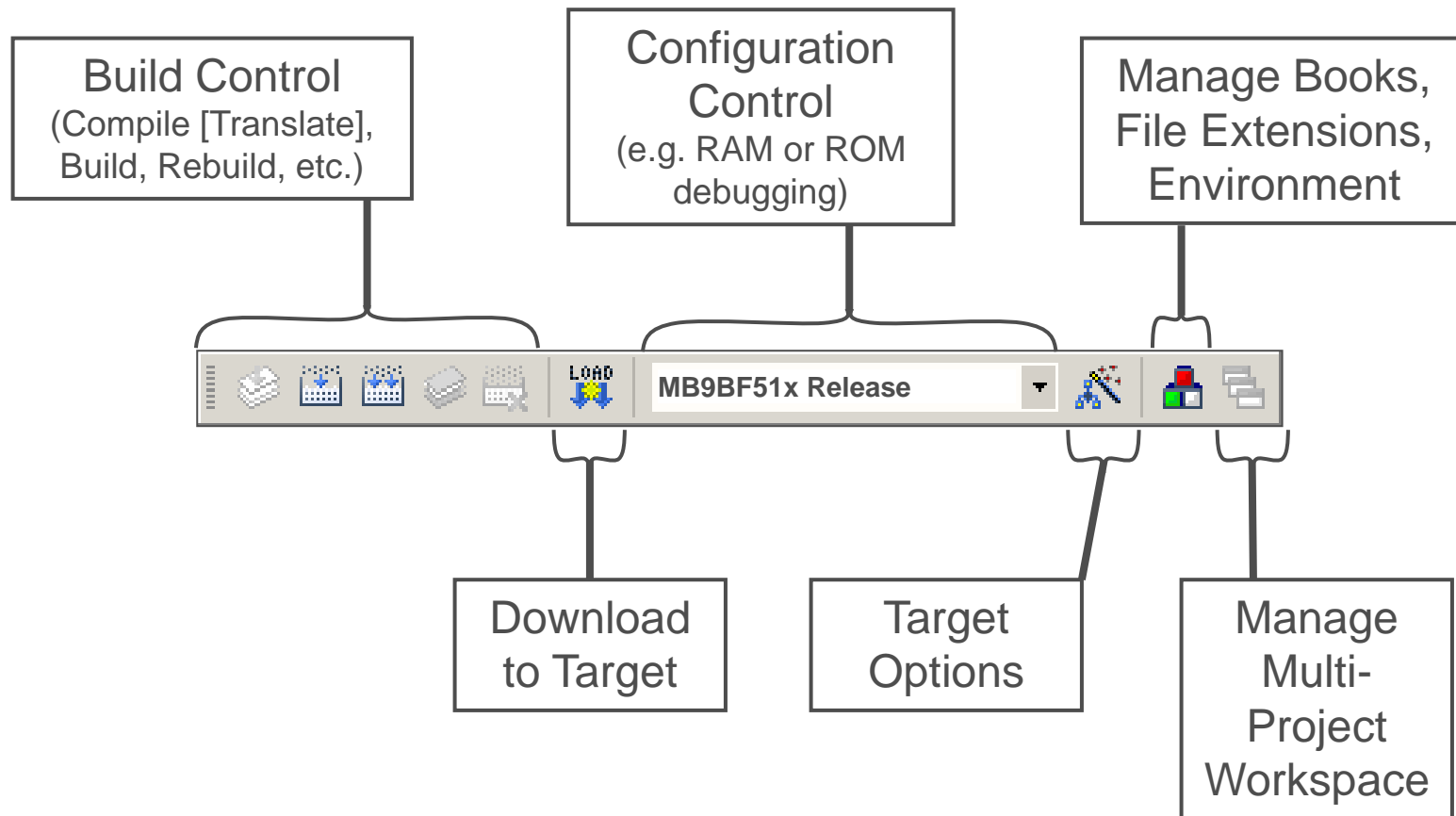

KEIL μ Vision – Project Window

■ μ Vision Project Window

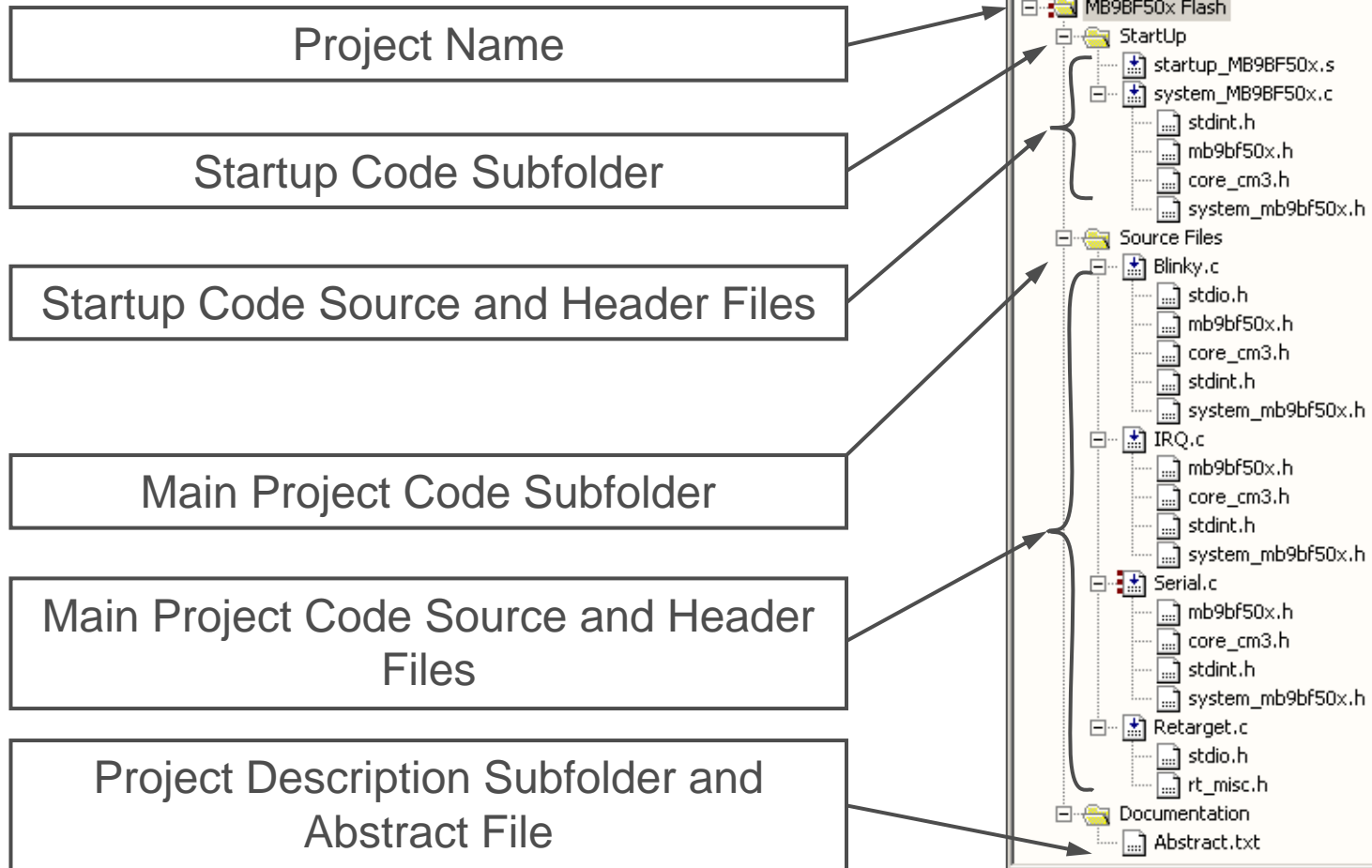

■ Making the Project

- Use Rebuild Icon



Project → Rebuild all target files

- Check for no errors in Output window below

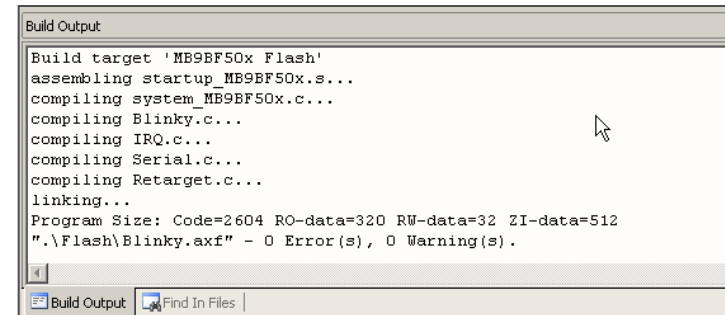

```
Build Output
Build target 'MB9BF50x Flash'
assembling startup_MB9BF50x.s...
compiling system_MB9BF50x.c...
compiling Blinky.c...
compiling IRQ.c...
compiling Serial.c...
compiling Retarget.c...
linking...
Program Size: Code=2604 RO-data=320 RW-data=32 ZI-data=512
".\Flash\Blinky.axf" - 0 Error(s), 0 Warning(s).
```

- Build errors are shown in Output window.

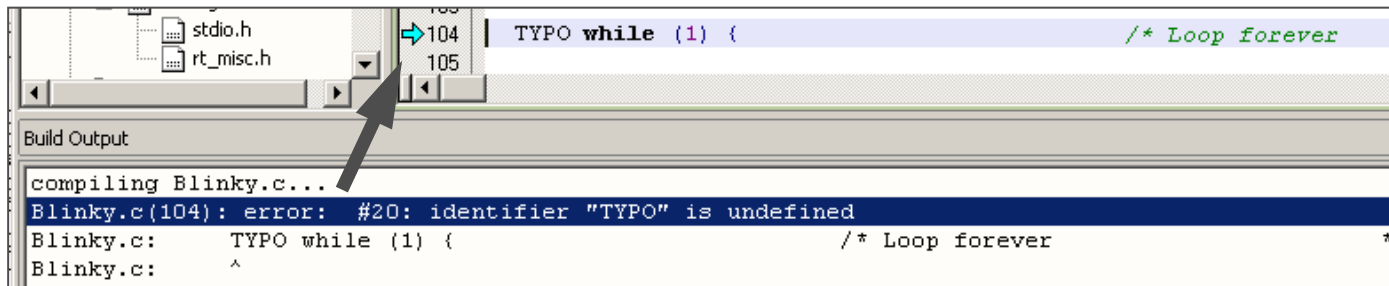

✓ Can be double-clicked by showing the source line with a blue arrow



```
Build Output
compiling Blinky.c...
Blinky.c(104): error: #20: identifier "TYPO" is undefined
Blinky.c:      TYPO while (1) {
Blinky.c:      ^
```

```
104 | TYPO while (1) { /* Loop forever
105 |
```

■ Start Debugging

- Download to target first, when MCU Flash does not contain the current application openend and built in the IDE
 - ✓ Use Download Icon () or Menu: Flash→Download
- Start Debug Session
 - ✓ Use Start/Stop Debug Icon () or Menu: Debug→Start/Stop Debug Session
- Ending Debug Session
 - ✓ Use same way as for starting debug session

- Debugging Icon Bar
 - During a Debug Session there will be visible a new icon bar

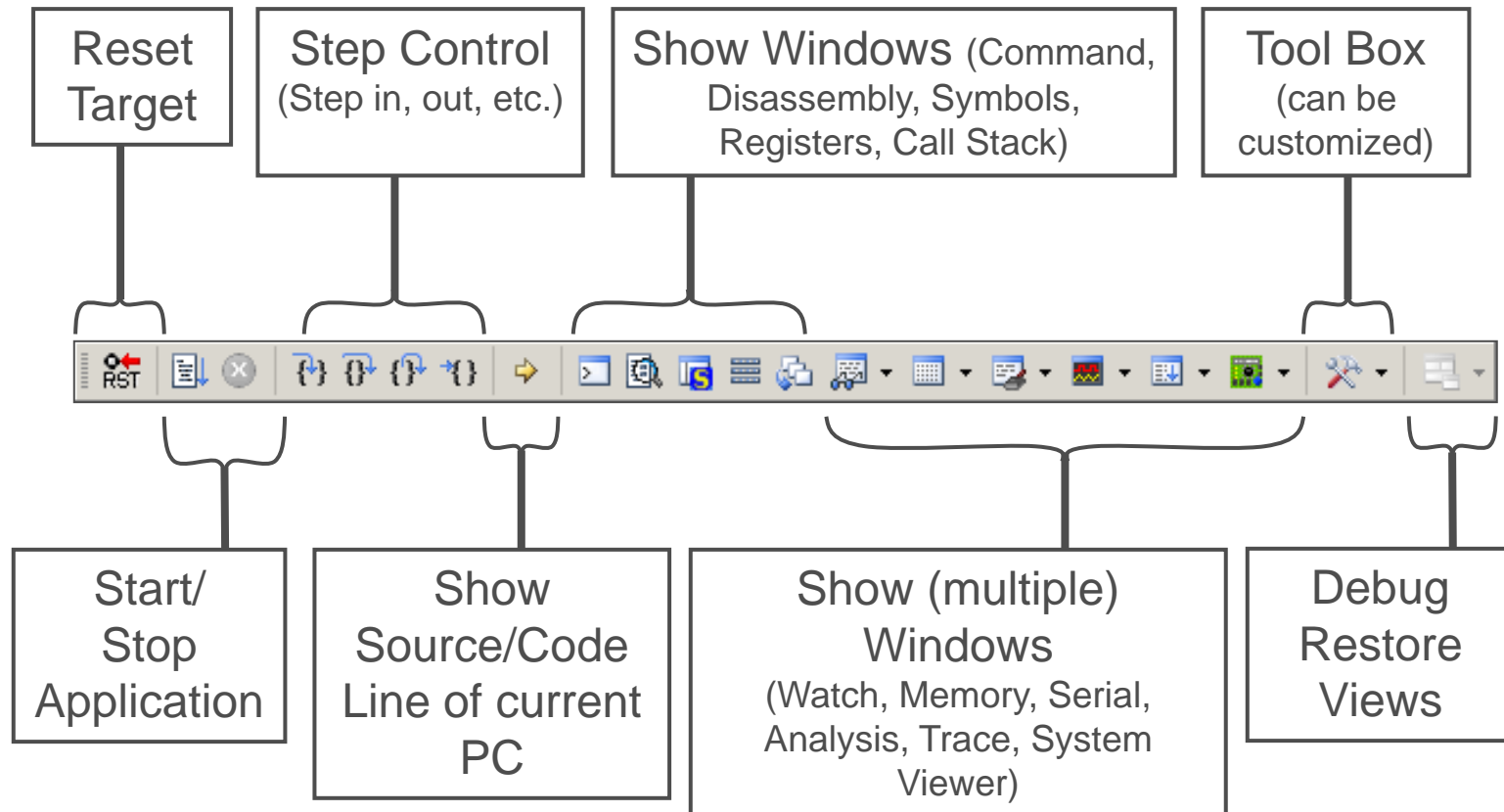

■ Source View

- The Source windows do not change contents but get additional information

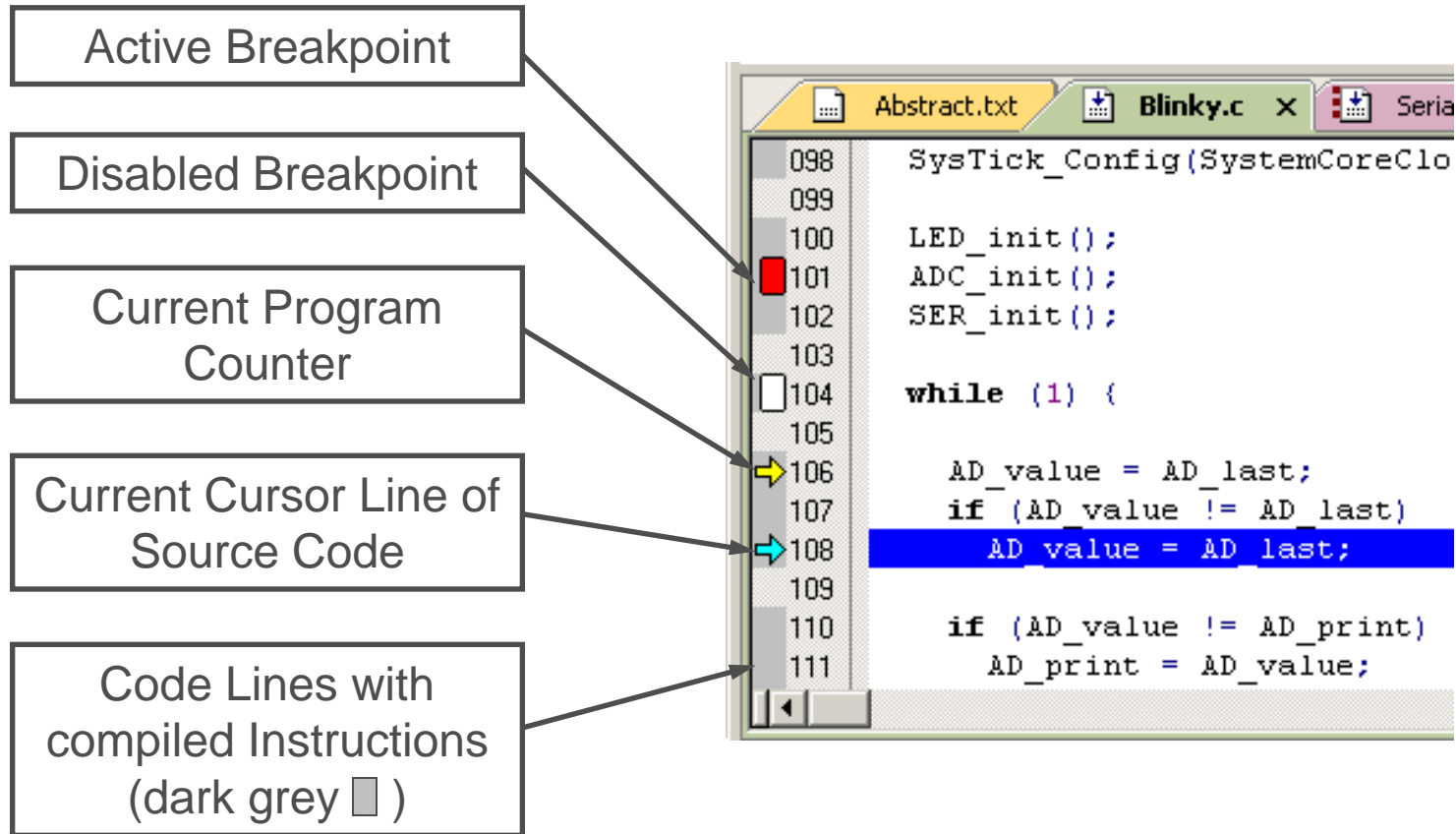

The screenshot shows the Source View window in KEIL μ Vision. The window displays the source code for `Blinky.c`. The code is as follows:

```
098 SysTick_Config(SystemCoreClo
099
100 LED_init();
101 ADC_init();
102 SER_init();
103
104 while (1) {
105
106     AD_value = AD_last;
107     if (AD_value != AD_last)
108         AD_value = AD_last;
109
110     if (AD_value != AD_print)
111         AD_print = AD_value;
```

The annotations on the left side of the image point to the following features in the Source View:

- Active Breakpoint: A red square next to line 101.
- Disabled Breakpoint: A white square next to line 104.
- Current Program Counter: A yellow arrow pointing to line 106.
- Current Cursor Line of Source Code: A cyan arrow pointing to line 108.
- Code Lines with compiled Instructions (dark grey \blacksquare): Lines 101, 102, 103, 106, 107, 108, 109, 110, and 111.

- Disassembly View
 - Mixed mode is selectable and deselectable

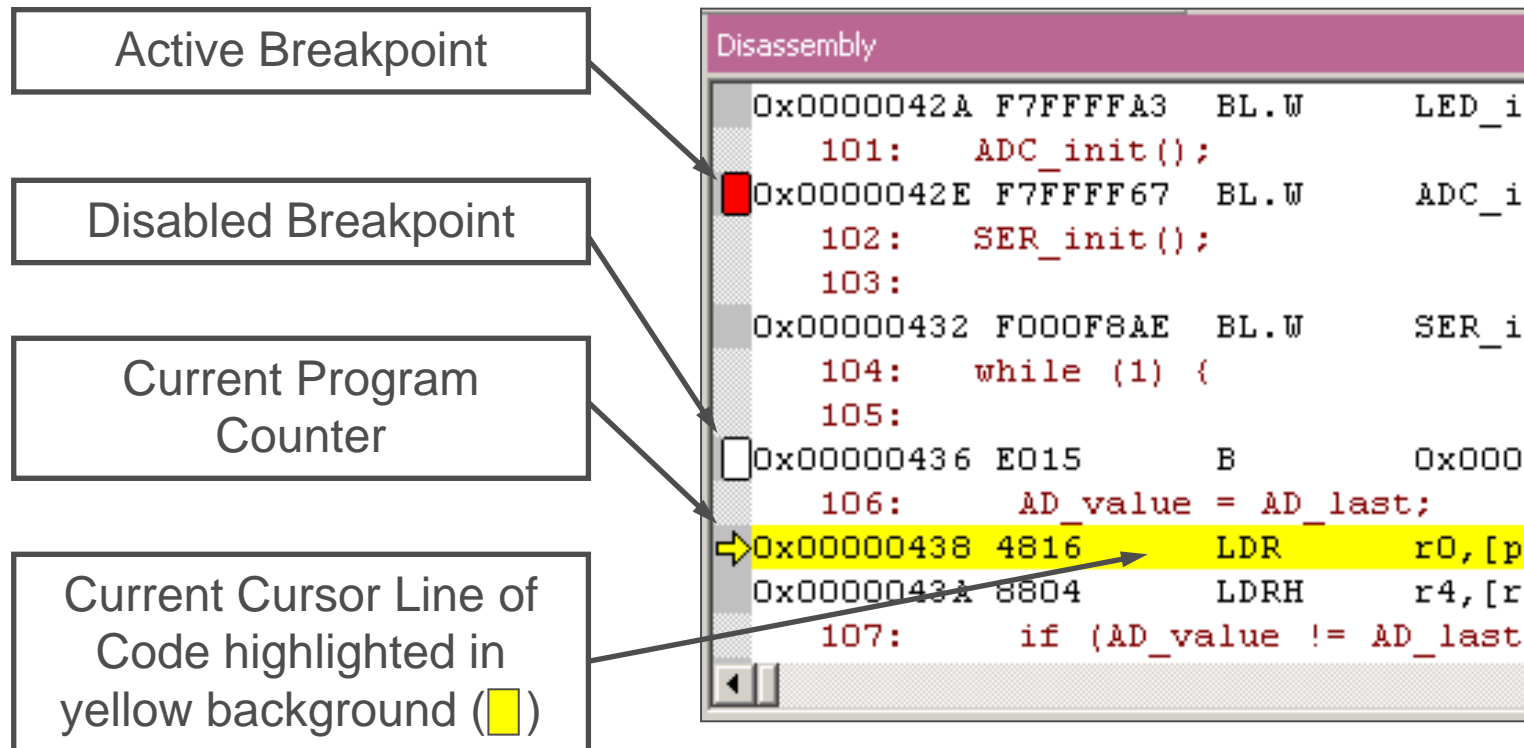

The screenshot shows the Disassembly window with the following code:

```
0x0000042A F7FFFA3 BL.W LED_i
101: ADC_init();
0x0000042E F7FFF67 BL.W ADC_i
102: SER_init();
103:
0x00000432 F000F8AE BL.W SER_i
104: while (1) {
105:
0x00000436 E015 B 0x0000
106: AD_value = AD_last;
0x00000438 4816 LDR r0, [p
0x0000043A 8804 LDRH r4, [r
107: if (AD_value != AD_last
```

Callouts from the left side of the image:

- Active Breakpoint: Points to the red square next to address 0x0000042E.
- Disabled Breakpoint: Points to the white square next to address 0x00000436.
- Current Program Counter: Points to the yellow arrow next to address 0x00000438.
- Current Cursor Line of Code highlighted in yellow background (■): Points to the yellow background of the line at address 0x00000438.

- Memory Window
 - Up to 4 Memory windows can be displayed in tabs
 - Memory is updated during runtime
 - Memory window tabs are shared with Watch windows

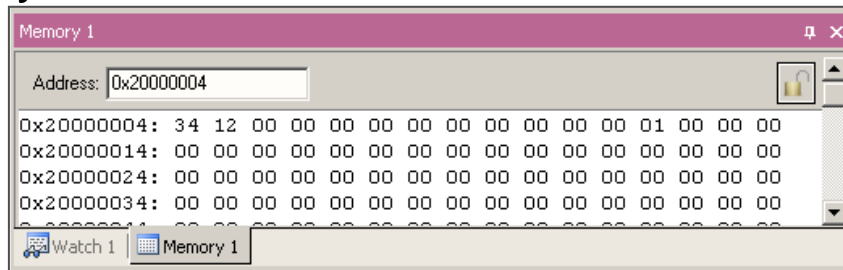

- Register View
 - Register view is a tab of the Project window
 - Changes are highlighted in dark blue text background
 - Register tree knots can be expanded

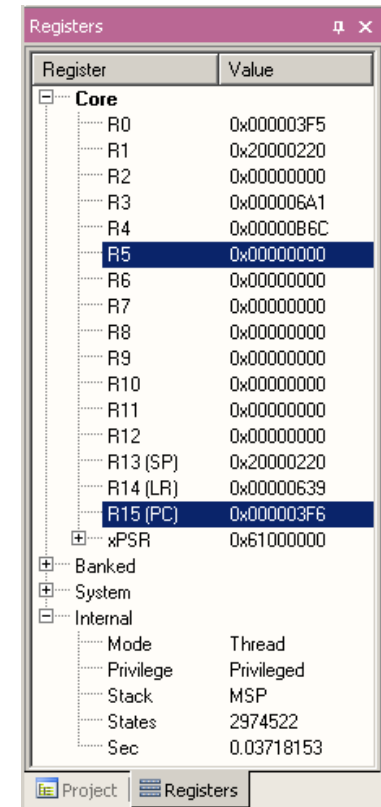

■ Variable Windows

• Watch Windows

- ✓ Up to 2 Watch windows are sharing their tabs with e.g. Memory and Local views
- ✓ Updated during runtime
- ✓ Any changes are highlighted in dark blue text background color
- ✓ Displayed values can be changed by user during break

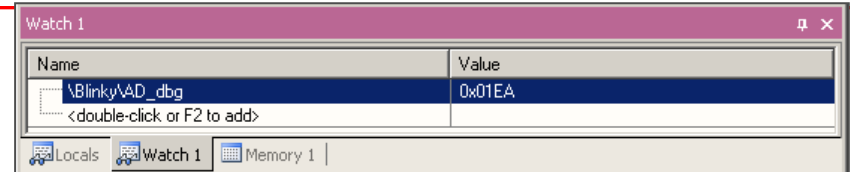

• Local View

- ✓ The local view shares the tab with e.g. Watch and Memory windows
- ✓ Any changes are highlighted in dark blue text background color
- ✓ Displayed values can be changed by user during break

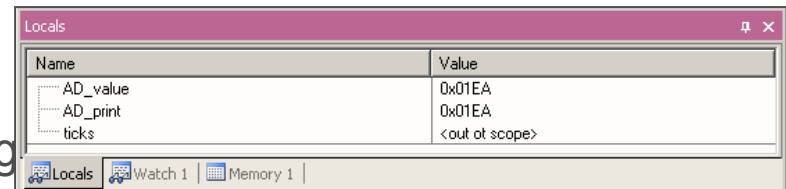

Trace via ITM

- Simple Trace views via Instrumentation Trace Macro is supported by μ LINK ME
 - ✓ Records
 - ✓ Exceptions
 - ✓ Counters

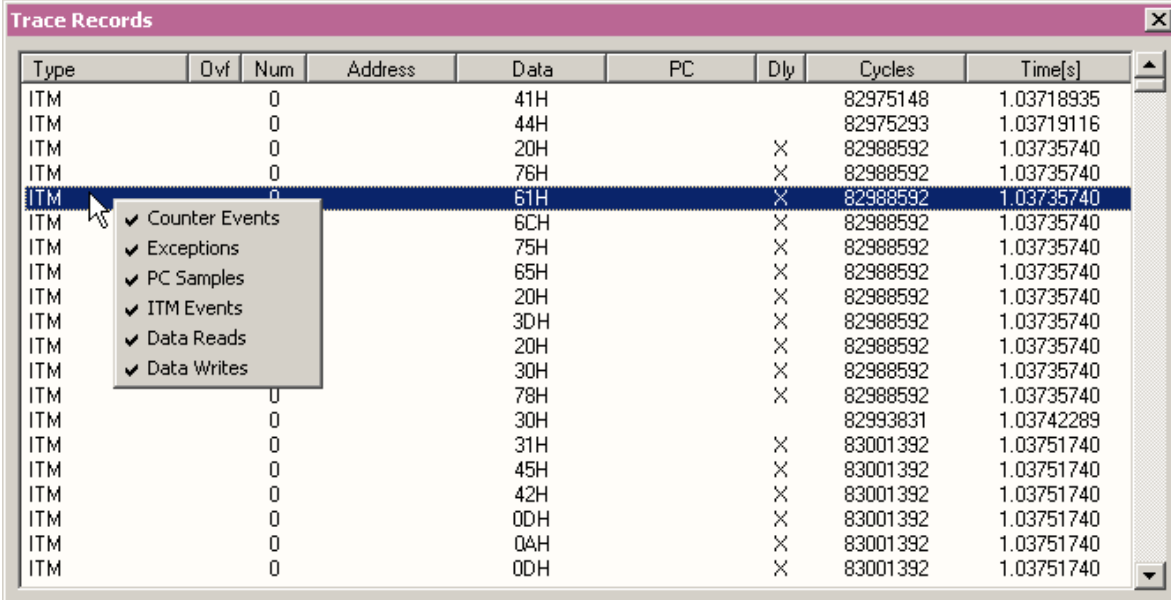

Type	Dly	Num	Address	Data	PC	Dly	Cycles	Time[s]
ITM		0	41H	41H			82975148	1.03718935
ITM		0	44H	44H			82975293	1.03719116
ITM		0	20H	20H		X	82988592	1.03735740
ITM		0	76H	76H		X	82988592	1.03735740
ITM		0	61H	61H		X	82988592	1.03735740
ITM		0	6CH	6CH		X	82988592	1.03735740
ITM		0	75H	75H		X	82988592	1.03735740
ITM		0	65H	65H		X	82988592	1.03735740
ITM		0	20H	20H		X	82988592	1.03735740
ITM		0	3DH	3DH		X	82988592	1.03735740
ITM		0	20H	20H		X	82988592	1.03735740
ITM		0	30H	30H		X	82988592	1.03735740
ITM		0	78H	78H		X	82988592	1.03735740
ITM		0	30H	30H			82993831	1.03742289
ITM		0	31H	31H		X	83001392	1.03751740
ITM		0	45H	45H		X	83001392	1.03751740
ITM		0	42H	42H		X	83001392	1.03751740
ITM		0	0DH	0DH		X	83001392	1.03751740
ITM		0	04H	04H		X	83001392	1.03751740
ITM		0	0DH	0DH		X	83001392	1.03751740

- Trace via ETM
 - Check settings in menu:
Flash→Configure Flash Tools... Tab:Debug

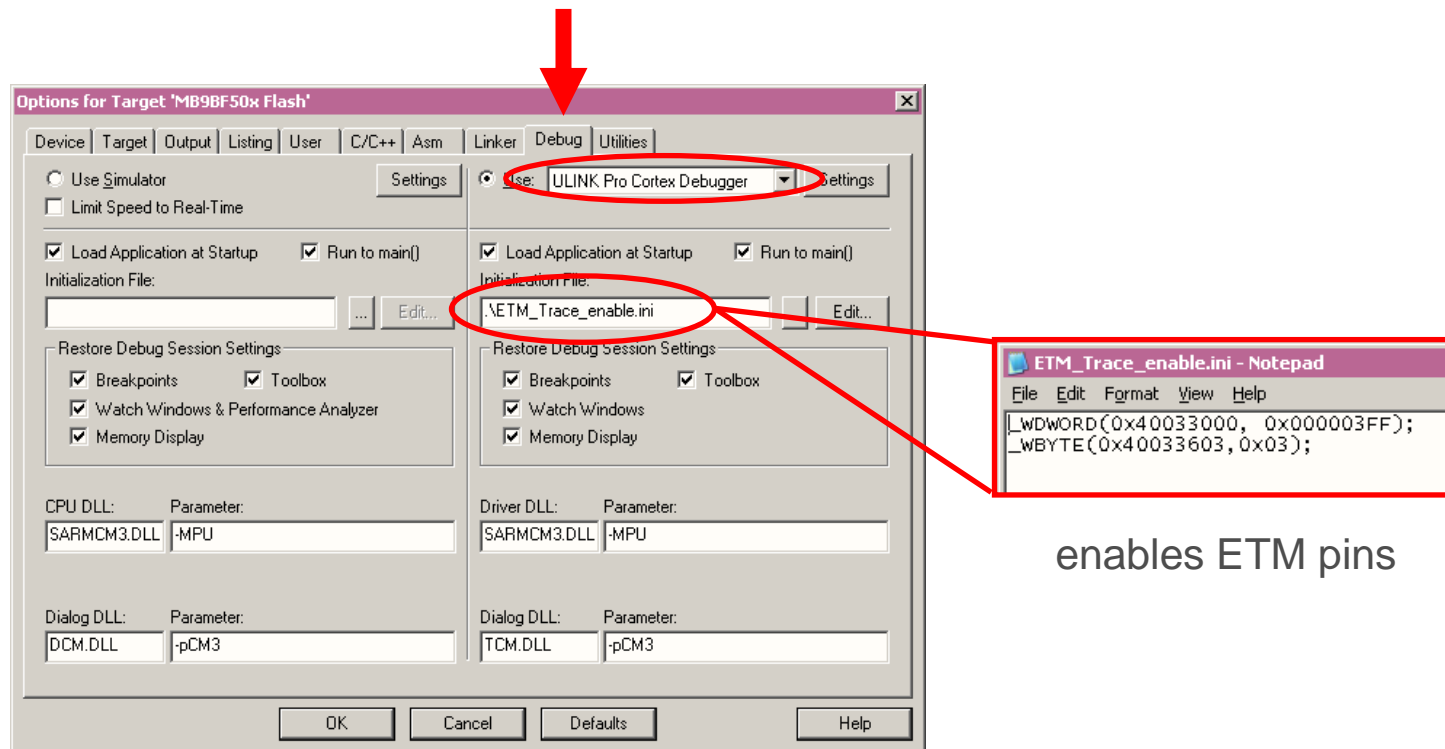

Options for Target 'MB9BF50x Flash'

Device Target Output Listing User C/C++ Asm Linker **Debug** Utilities

Use Simulator Use: **ULINK Pro Cortex Debugger**

Limit Speed to Real-Time

Load Application at Startup Run to main() Load Application at Startup Run to main()

Initialization File: Edit...

Restore Debug Session Settings

Breakpoints Toolbox Watch Windows & Performance Analyzer Memory Display

CPU DLL: SARMCM3.DLL Parameter: -MPU

Driver DLL: SARMCM3.DLL Parameter: -MPU

Dialog DLL: DCM.DLL Parameter: -pCM3

Dialog DLL: TCM.DLL Parameter: -pCM3

OK Cancel Defaults Help

ETM_Trace_enable.ini - Notepad

File Edit Format View Help

```
_LWORD(0x40033000, 0x000003FF);  
_WBYTE(0x40033603, 0x03);
```

enables ETM pins

- Instruction Trace
 - Real Time Trace recording
 - Output can be filtered by several ETM and ITM events
 - Trace buffer is held in PC memory and transferred to μ Vision on break

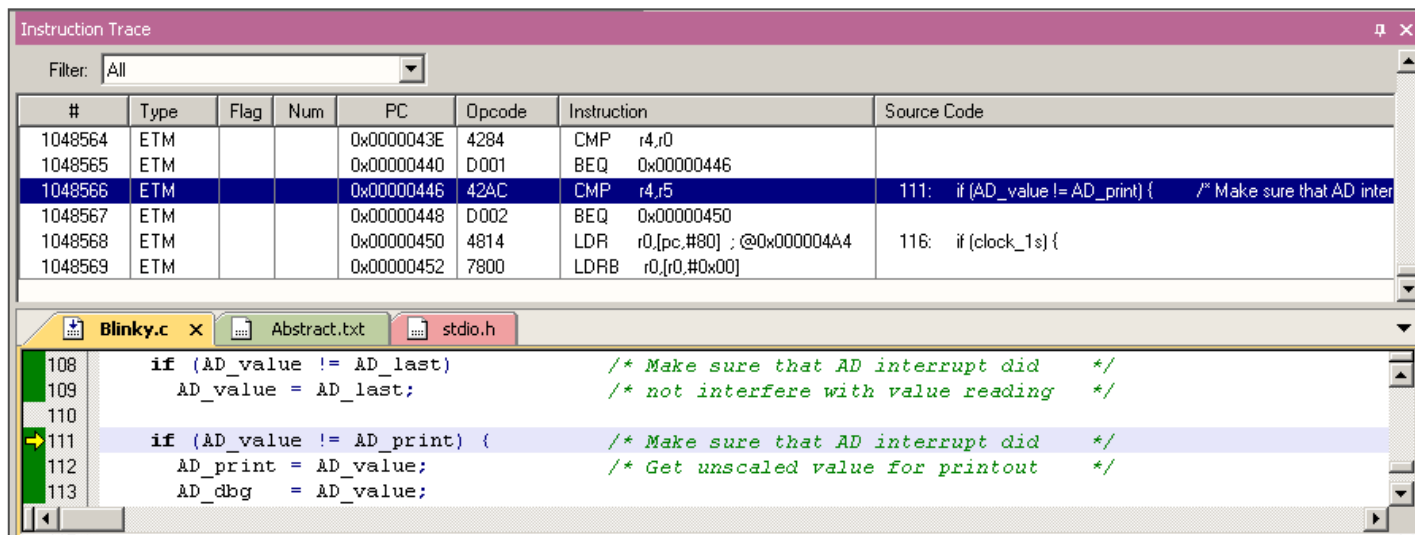

The screenshot displays the 'Instruction Trace' window in KEIL μ Vision. The window is divided into two main sections. The top section is a table with columns: #, Type, Flag, Num, PC, Opcode, Instruction, and Source Code. The bottom section shows the source code for 'Blinky.c' with line numbers 108 to 113. The instruction at PC 0x00000446 (42AC) is highlighted in blue, corresponding to line 111 of the source code.

#	Type	Flag	Num	PC	Opcode	Instruction	Source Code
1048564	ETM			0x0000043E	4284	CMP r4,r0	
1048565	ETM			0x00000440	D001	BEQ 0x00000446	
1048566	ETM			0x00000446	42AC	CMP r4,r5	111: if (AD_value != AD_print) { /* Make sure that AD inter
1048567	ETM			0x00000448	D002	BEQ 0x00000450	
1048568	ETM			0x00000450	4814	LDR r0,[pc,#80] ;@0x000004A4	116: if (clock_1s) {
1048569	ETM			0x00000452	7800	LDRB r0,[r0,#0x00]	

```
108     if (AD_value != AD_last)           /* Make sure that AD interrupt did */
109         AD_value = AD_last;           /* not interfere with value reading */
110
111     if (AD_value != AD_print) {        /* Make sure that AD interrupt did */
112         AD_print = AD_value;           /* Get unscaled value for printout */
113         AD_dbg   = AD_value;
```

■ Simulator

- The Core Simulator can be selected by the menu: [Flash] → [Configure Flash Tools...] → [Debug] and then choosing [Use Simulator]
- Look & feel is like using ULINK debugger
- Controlable also with *.ini files

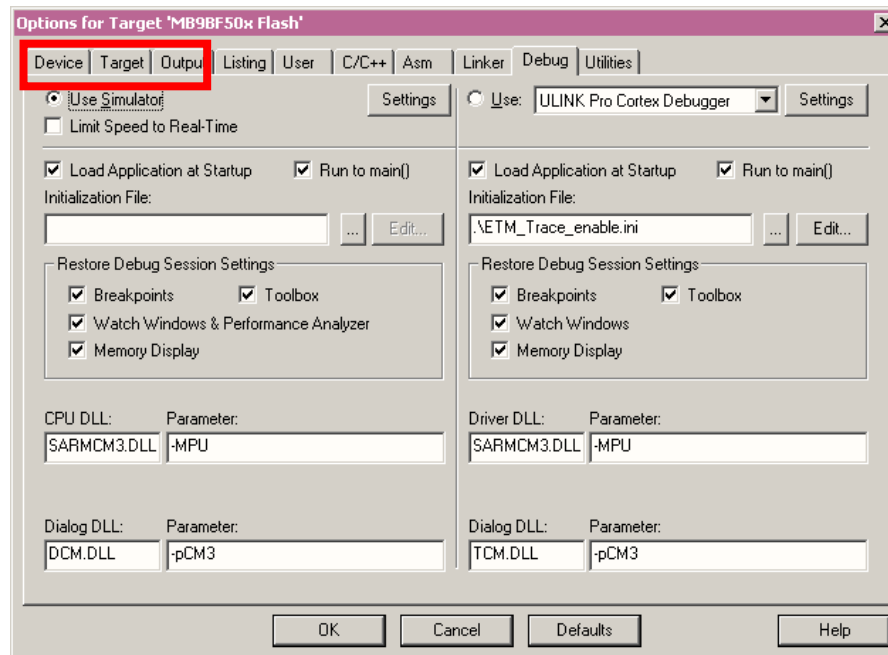



Finally

- Please check the following website, for any available updates

www.cypress.com

- Gültig für EU-Länder:
 - Gemäß der Europäischen WEEE-Richtlinie und deren Umsetzung in landesspezifische Gesetze nehmen wir dieses Gerät wieder zurück.
 - Zur Entsorgung schicken Sie das Gerät bitte an die folgende Adresse:
- Valid for European Union Countries:
 - According to the European WEEE-Directive and its implementation into national laws we take this device back.
 - For disposal please send the device to the following address:



Cypress Semiconductor
198 Champion Court
San Jose, CA 95134 USA
Tel: +1-408-943-2600



- This board is compliant with China RoHS